

*Master in Bionics Engineering*

*University of Pisa and Scuola Superiore Sant'Anna*

**Human and Animal Models for BioRobotics**

THE BIROBOTICS  
INSTITUTE



Scuola Superiore  
Sant'Anna

# Introduction to bioinspired robotics

Cecilia Laschi

The BioRobotics Institute

Scuola Superiore Sant'Anna

[cecilia.laschi@santannapisa.it](mailto:cecilia.laschi@santannapisa.it)

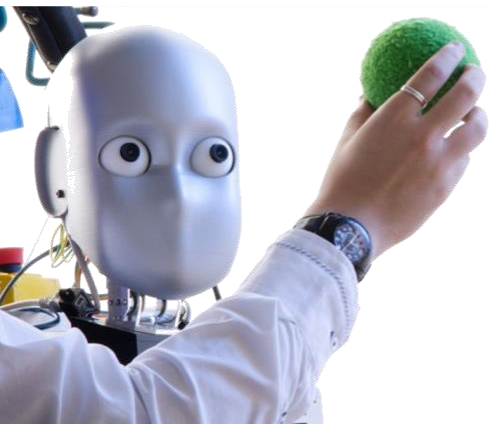

# Lessons from Nature

## Bioinspiration in robotics



# Bioinspiration

Nevertheless... ..natural selection is not engineering

Organisms that are capable of surviving are not necessarily **optimal** for their performance.

They need to survive long enough to reproduce.

Models are never complete or correct: need to interpret with caution.

“**Simply copying** a biological system is either **not feasible** (even a single neuron is too complicated to be synthesized artificially in every detail) or is **of little interest** (animals have to satisfy multiple constraints that do not apply to robots, such as keeping their metabolism running and getting rid of parasites), or **the technological solution is superior** to the one found in nature (for example, the biological equivalent of the wheel has yet to be discovered).



Rather, the goal is to work out **principles** of biological systems and transfer those to robot design.” *Rolf Pfeifer*

**Extract key principles**



THE BIROBOTICS  
INSTITUTE



# Lessons from Nature: simplifying principles

Scuola Superiore  
Sant'Anna



Too complex?  
Rather too simple?



Studying living organisms and  
understanding what makes their  
behavior so smart and efficient

[www.ghumil.com](http://www.ghumil.com)

In robotics, we need **simplifying principles** for control and behavior

# Simplexity

**Simplexity** comprises a **collection of solutions** that can be observed in living organisms which, despite the complexity of the world in which they live, allows them to **act and project the consequences of their actions into the future**.

It is **not** a matter of **simplified model** adoption, but rather an approach to **using simplifying principles**.

Biological systems can use:

- Multiple reference frames
- Anticipation and prediction
- Inhibition to select and adapt
- Redundancy
- Biomechanics and internal models
- Synergies
- Laws of motion
- Emotion

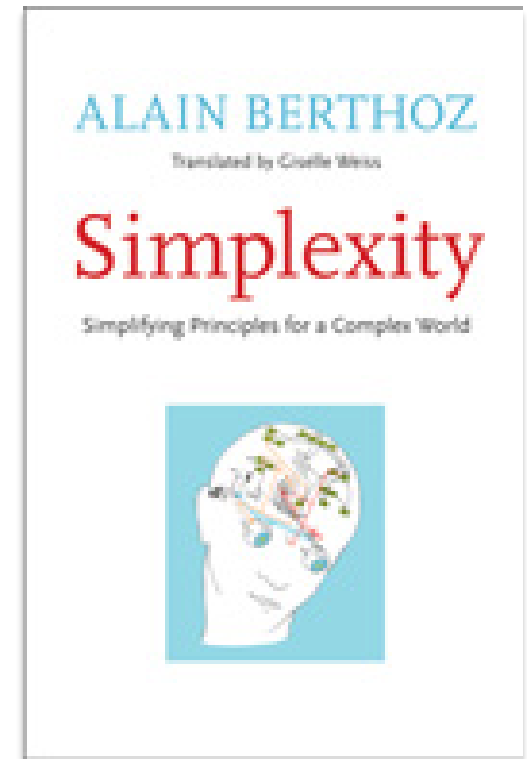

A. Berthoz (2012), *Simplexity: Simplifying principles for a Complex World*. Yale University Press.

U. Alon (2007), "Simplicity in Biology", *Nature*, 446(7135):497







# Summary of bioinspired approaches to robotics (in this course...)

Scuola Superiore  
Sant'Anna

Robot vision

Robot sensors

Robot mechanics  
and kinematics

Robot control

Robot behaviour

Robot navigation

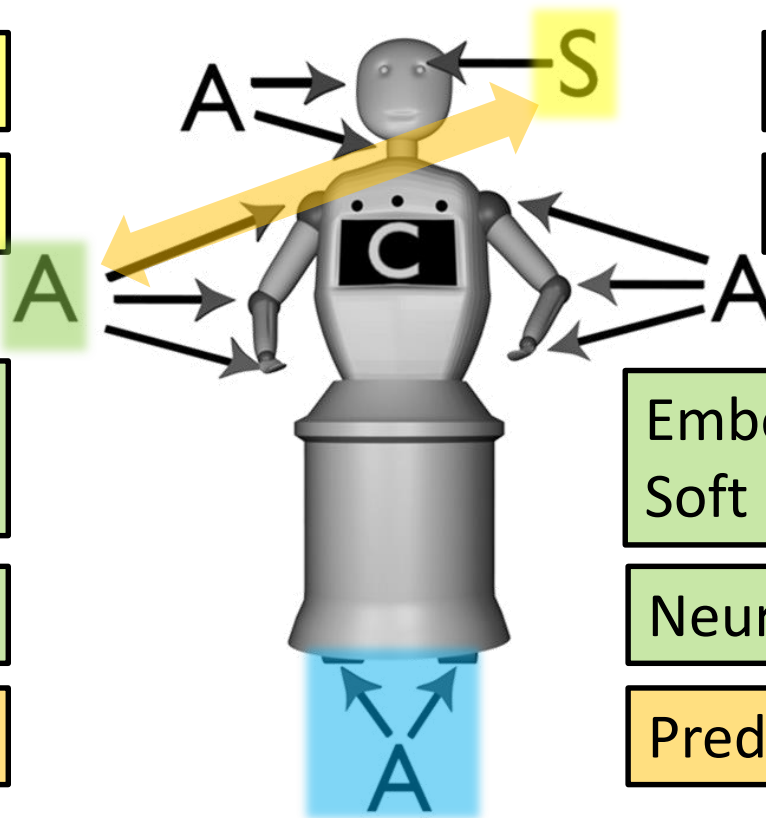

Bioinspired vision

Vestibular system

Embodied Intelligence,  
Soft Robotics

Neurocontrollers

Predictive behaviour

Bioinspired navigation,  
Soft locomotion



# Summary of bioinspired approaches to robotics (in this course...)

Scuola Superiore  
Sant'Anna

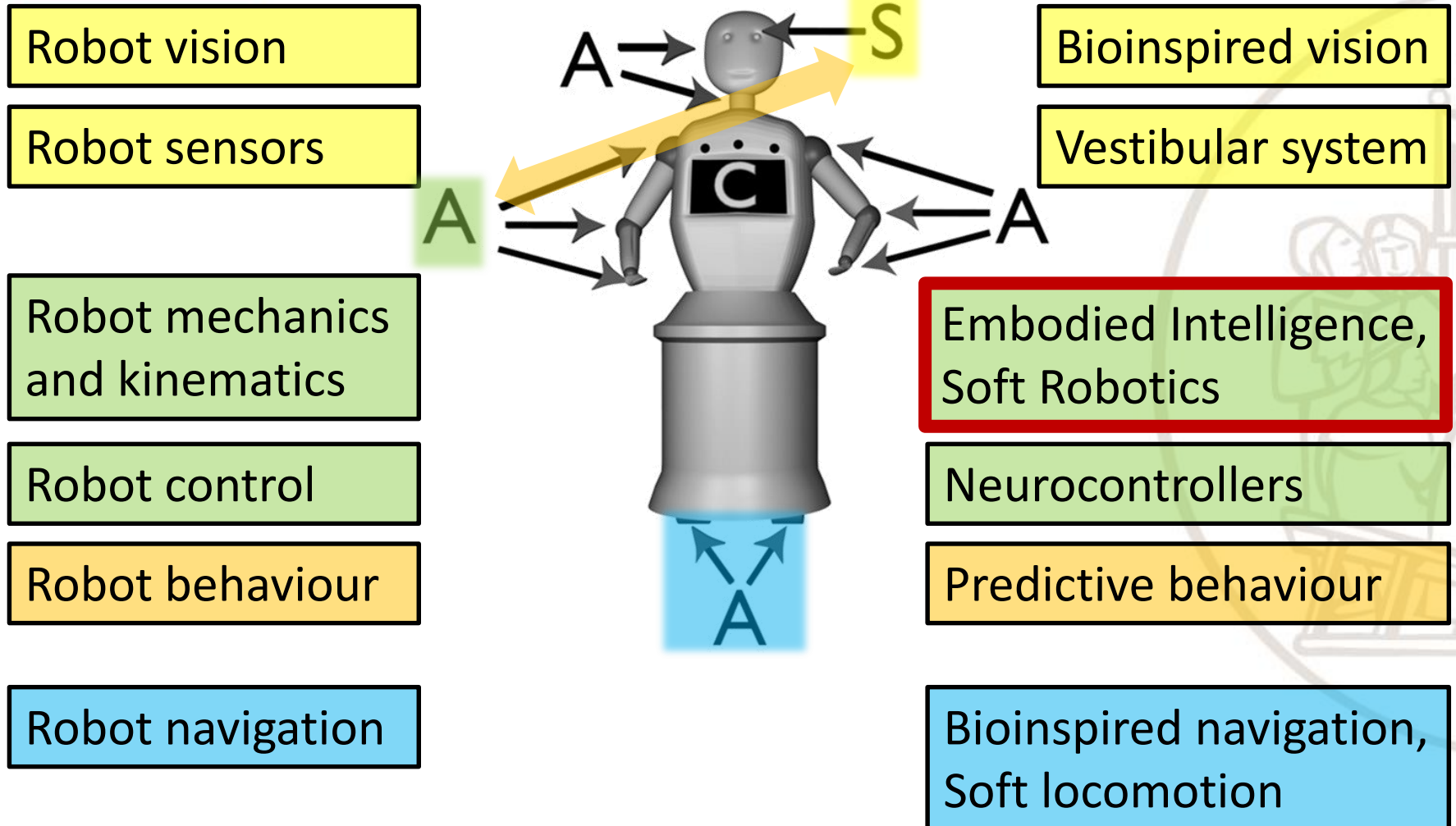



# Embodied Intelligence: the modern view of Artificial Intelligence

THE BIROBOTICS  
INSTITUTE



Scuola Superiore  
Sant'Anna

## Classical approach

The focus is on the brain and central processing



## Modern approach

The focus is on interaction with the environment. Cognition is emergent from system-environment interaction



Rolf Pfeifer and Josh C. Bongard, *How the body shapes the way we think: a new view of intelligence*, The MIT Press, Cambridge, MA, 2007



# Properties of complete agents

1. *They are subject to the laws of physics* (energy dissipation, friction, gravity).
2. *They generate sensory stimulation* through motion and generally through interaction with the real world.
3. *They affect the environment* through behavior.
4. *They are complex dynamical systems* which, when they interact with the environment, have *attractor states*.
5. *They perform morphological computation*.

These properties are simply unavoidable consequences of **embodiment**.

These are also the properties that can be exploited for generating behavior, and how this can be done is specified in the design principles.



# Properties of complete agents

Scuola Superiore  
Sant'Anna

*1. A complete agent is subject to the laws of physics.*

Walking requires energy, friction, and gravity in order to work. Because the agent is embodied, it is a physical system (biological or not) and thus subject to the laws of physics from which it cannot possibly escape; it must comply with them. If an agent jumps up in the air, gravity will inevitably pull it back to the ground.

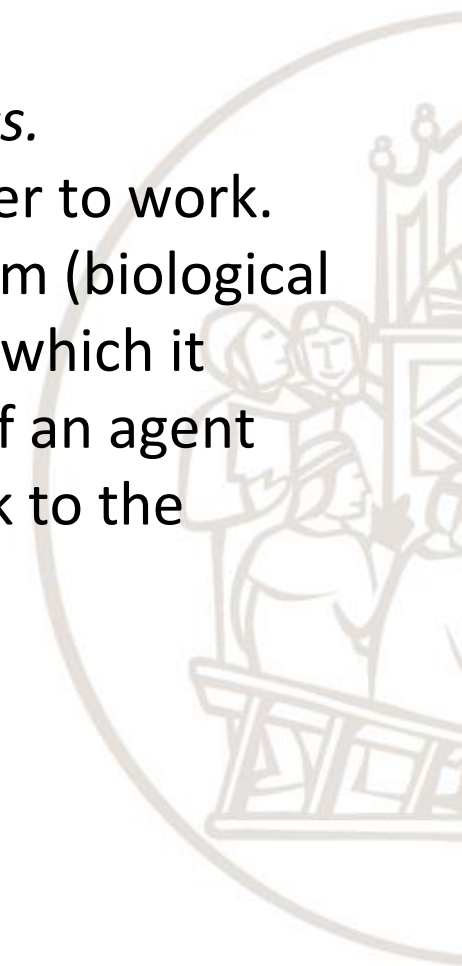



# Properties of complete agents

## *2. A complete agent generates sensory stimulation.*

When we walk, we generate sensory stimulation, whether we like it or not: when we move, objects seem to flow past us (this is known as optic flow);

by moving we induce wind that we then sense with our skin and our hair;

walking also produces pressure patterns on our feet;

and we can feel the regular flexing and relaxing of our muscles as our legs move.

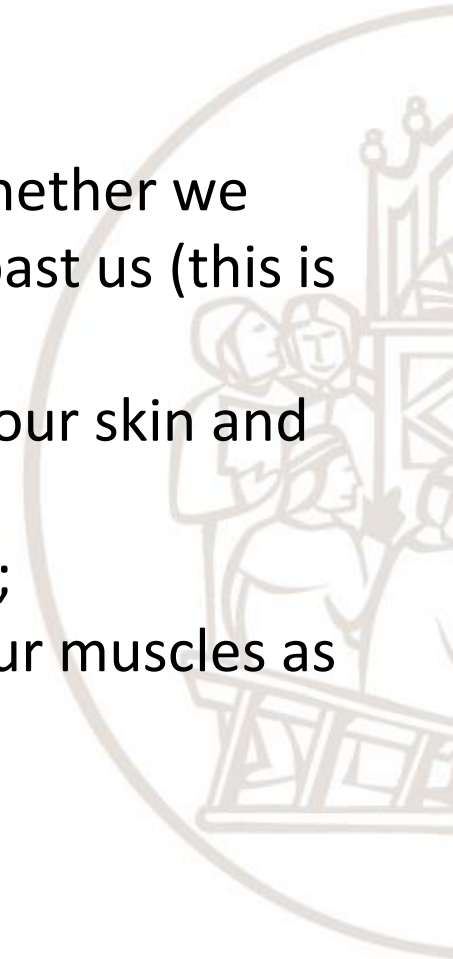



# Properties of complete agents

Scuola Superiore  
Sant'Anna

## 3. *A complete agent affects its environment.*

When we walk across a lawn, the grass is crushed underfoot;  
when we breathe, we blow air into the environment;  
when we walk and burn energy, we heat the environment;  
when we drink from a cup, we reduce the amount of liquid in the glass;  
when we drop a cup it breaks;  
when we talk we put pressure waves out into the air;  
when we sit down in a chair it squeaks and the cushion is squashed.

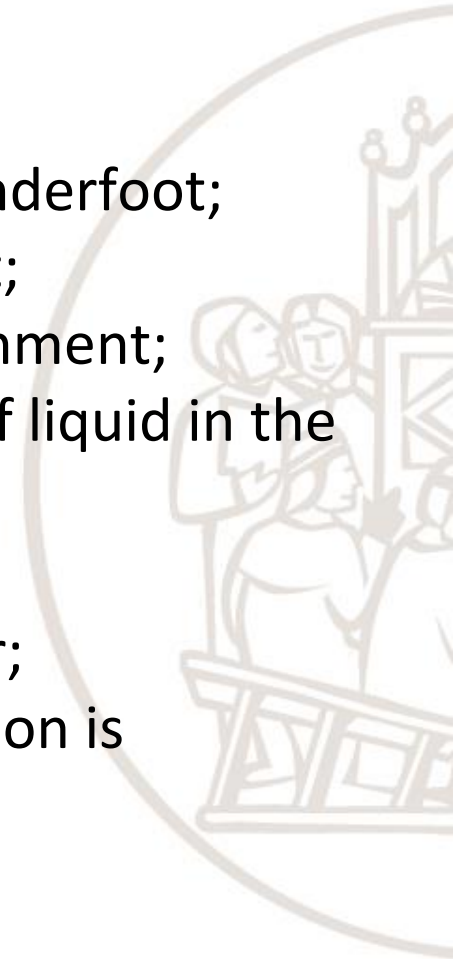



# Properties of complete agents

4. *Agents tend to settle into attractor states.*

Agents are dynamical systems, and as such they have a tendency to settle into so-called attractor states. Horses, for example, can walk, trot, canter, and gallop, and we—or at least experts—can clearly identify when the horse is in one of these walking modes, or gaits, the more technical word for these behaviors.

These gaits can be viewed as **attractor states**. The horse is always in one of these states, except for short periods of time when it transitions between two of them, for example from canter to gallop. We should point out here that the attractor states into which an agent settles are always the result of the interaction of three systems: the agent's body, its brain (or control system), and its environment.

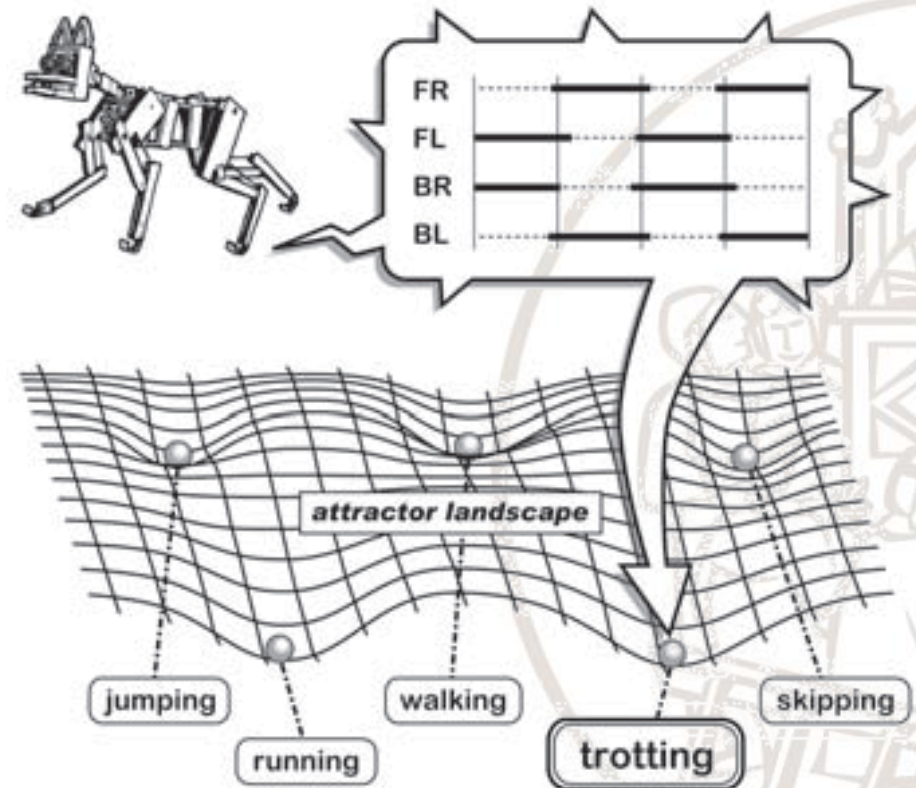



# Properties of complete agents

Scuola Superiore  
Sant'Anna

## 5. *Complete agents perform morphological computation.*

By “morphological computation” we mean that certain processes are performed by the body that otherwise would have to be performed by the brain.

An example is the fact that the human leg’s muscles and tendons are elastic so that the knee, when the leg impacts the ground while running, performs small adaptive movements without neural control.

The control is supplied by the muscle-tendon system itself, which is part of the morphology of the agent.

It is interesting to note that systems that are not complete, in the sense of the word used here, hardly ever possess all of these properties. For example, a vision system consisting of a fixed camera and a desktop computer does not generate sensory stimulation because it cannot produce behavior, and it influences the environment only by emitting heat and light from the computer screen. Moreover, it does not perform morphological computation and does not have physical attractor states that could be useful to the system.

# Morphological computation

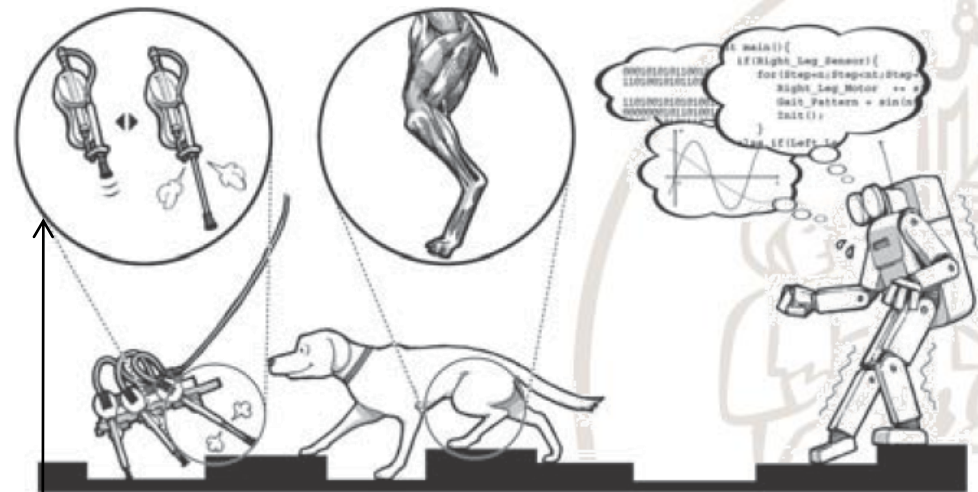
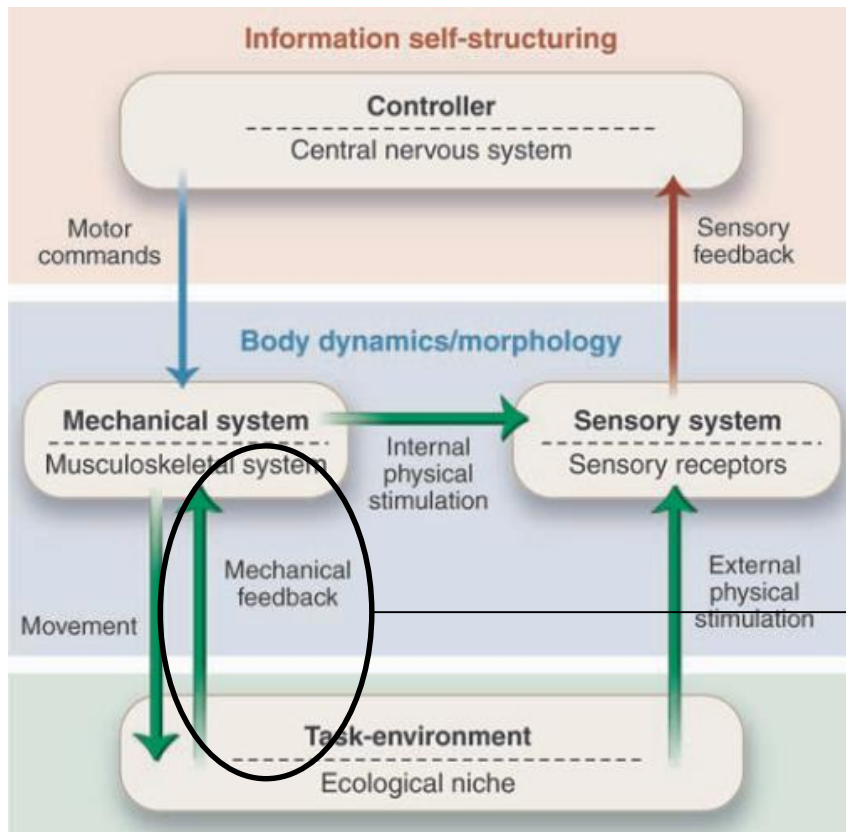



# Morphological Computation

As any transformation of information can be named as *computing*, *Morphological Computation* endows all those behaviours where computing is mediated by the mechanical properties of the physical body

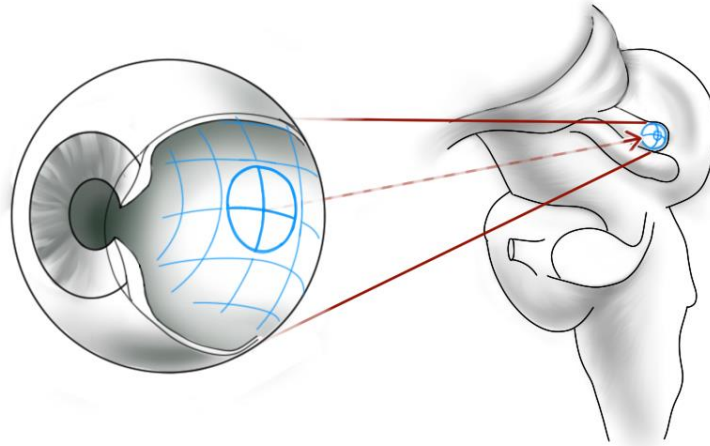

## The arrangement

of the motor, perceptive and processing units



## The shape

as body structure, specifies the behavioral response of the agent

## The mechanical properties

allow emergent behaviors and highly adaptive interaction with the environment

Zambrano D, Cianchetti M, Laschi C (2014) "The Morphological Computation Principles as a New Paradigm for Robotic Design" in *Opinions and Outlooks on Morphological Computation*, H. Hauser, R. M. Fuchslin, R. Pfeifer (Ed.s), pp. 214-225.





# Agent Design Principle 1

The **three-constituents** principle:

- define the ecological niche
- define the desired behaviour and tasks
- design the agent

ENVIRONMENT  
TASK  
BODY





# Agent Design Principle 2

Scuola Superiore  
Sant'Anna

The **complete-agent** principle:

- think about the complete agent behaving in the real world





# Agent Design Principle 3

## Cheap design:

- If agents are built to exploit the properties of the ecological niche and the characteristics of the interaction with the environment, their design and construction will be much easier, or 'cheaper'



Passive  
walker



# Agent Design Principle 4

Scuola Superiore  
Sant'Anna

## Redundancy:

- Intelligent agents must be designed in such a way that
  - (a) their different sub-systems function on the basis of different physical processes, and
  - (b) there is partial overlap of functionality between the different sub-systems

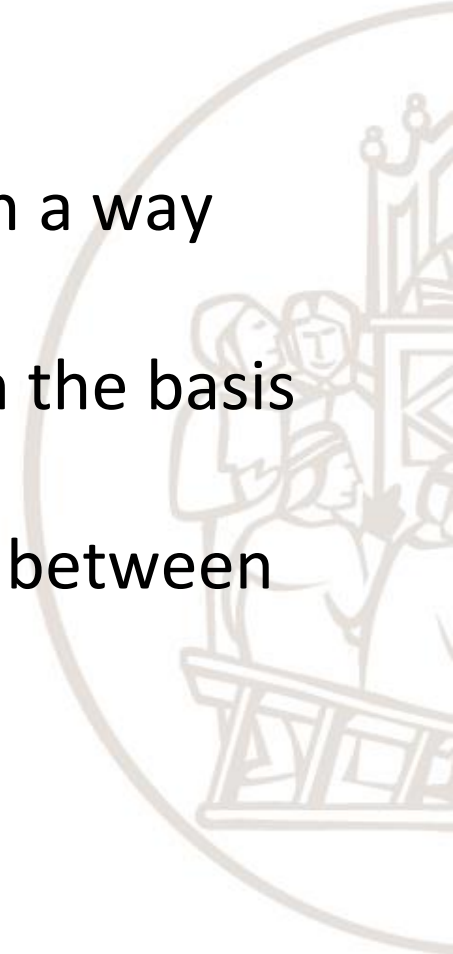



# Agent Design Principle 5

Scuola Superiore  
Sant'Anna

## Sensory-Motor Coordination:

- through sensory-motor coordination, structured sensory stimulation is induced.





# Agent Design Principle 6

## Ecological balance:

1. given a certain task environment, there has to be a match between the complexities of the agent's sensory, motor, and neural systems
2. there is a certain balance or task distribution between morphology, materials, control, and environment.

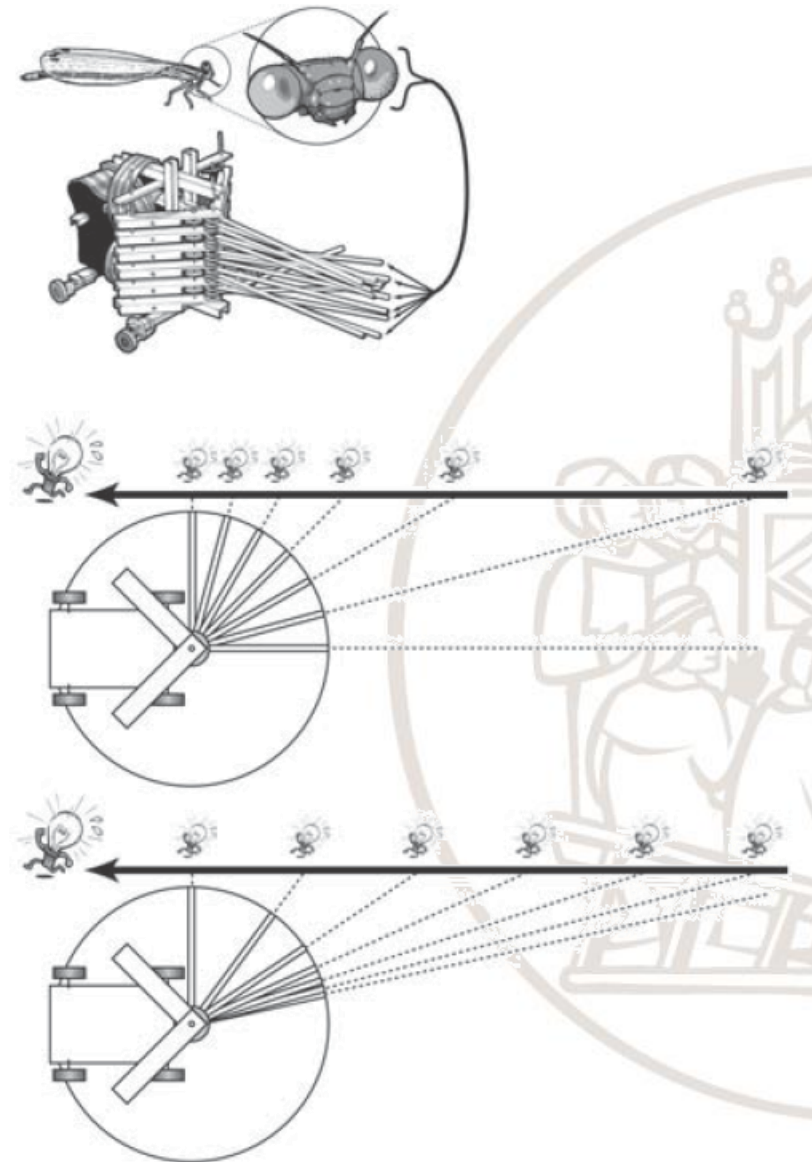



# Agent Design Principle 7



Scuola Superiore  
Sant'Anna

## **Parallel, loosely coupled processes:**

intelligence is emergent from a large number of parallel processes that are often coordinated through embodiment, in particular via the embodied interaction with the environment

Reactive architectures







# Agent Design Principle 8



Scuola Superiore  
Sant'Anna

## **Value:**

agents are equipped with a value system which constitutes a basic set of assumptions about what is good for the agent



## Simplifying principles in reaching

# The octopus arm embodied intelligence

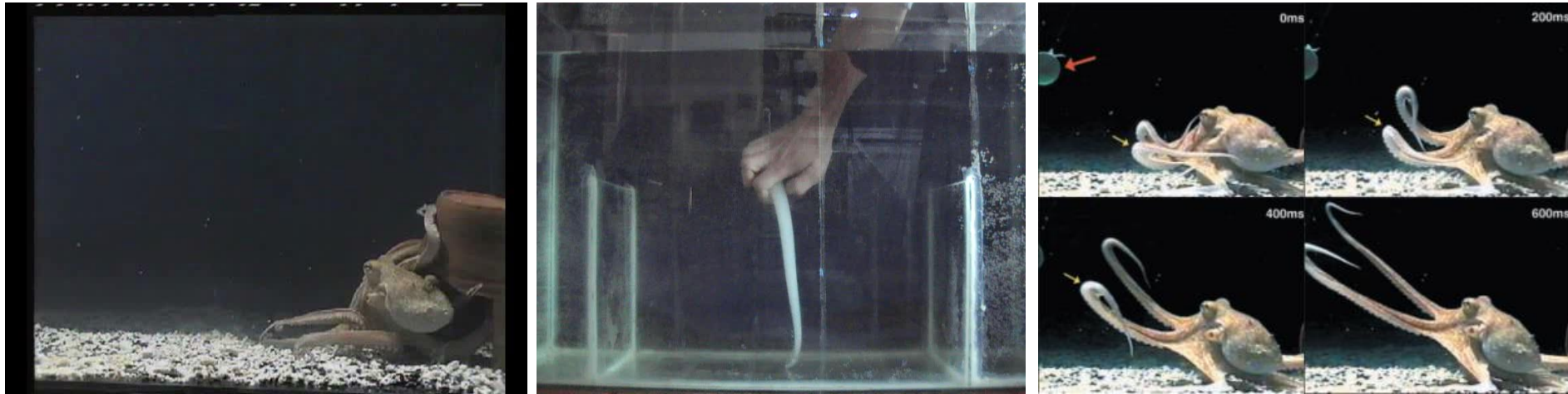

- stiffening wave from base to distal part, that can start from any part of the arm;
- movement executed in about 1 second, velocities in the range of 20–60 cm/s;
- control divided between central and peripheral: from brain: **3 parameters** (yaw and pitch of arm base and peak velocity of bend-point); locally: propagation of stiffness



# Simplifying principles in reaching

Biological behaviour



Robot behaviour

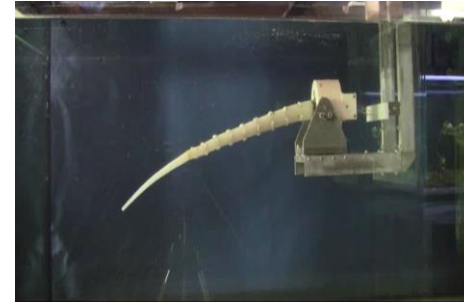
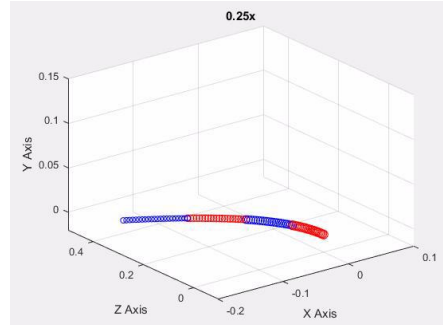

- Soft robot
- Passive distal part
- Water
- Neural controller (not octopus-like!)

Environmental properties

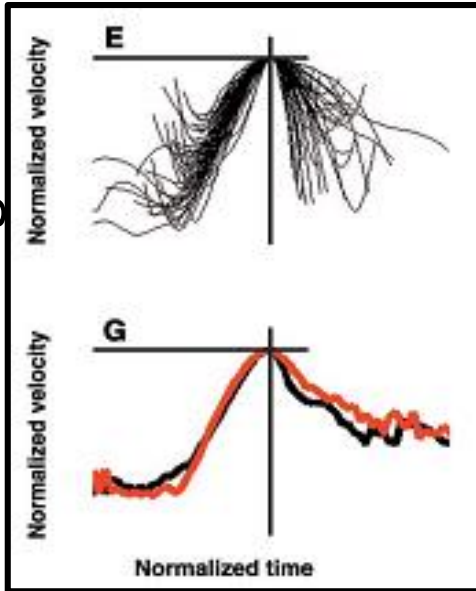

TANGENTIAL BEND PROPAGATION VELOCITY OF THE OCTOPUS ARM

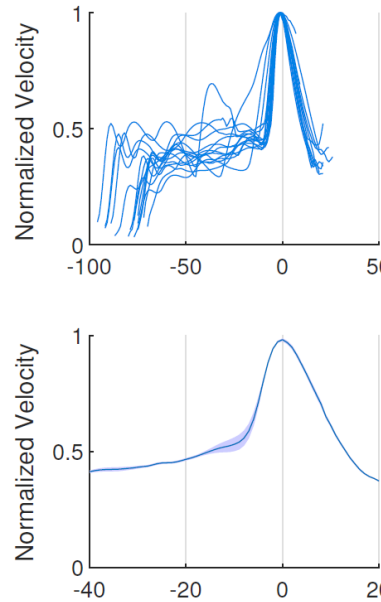

TANGENTIAL BEND PROPAGATION VELOCITY OF THE SOFT ROBOT

Configuration	Learnable	Bend Propagation Strategy
Lower Environment Density (air)	No	N/A
Lower Environment Density (air) + Higher Body Stiffness and Viscosity	Yes	No
Actuators at Tip (4th Section)	No	N/A
Actuators at 3rd Section	Yes	No
Only two actuators at the base	Yes	Yes
Three Actuators at base + One at the tip	Yes	Yes
Shorter Manipulator (Only two sections)	Yes	No
Cylindrical Shape	No	N/A
Double module experiment	Yes	No

Morphological properties

Morphological and environmental properties are the factors that affect the invariant velocity profile observed



## Pulsed-jet swimming in cephalopods

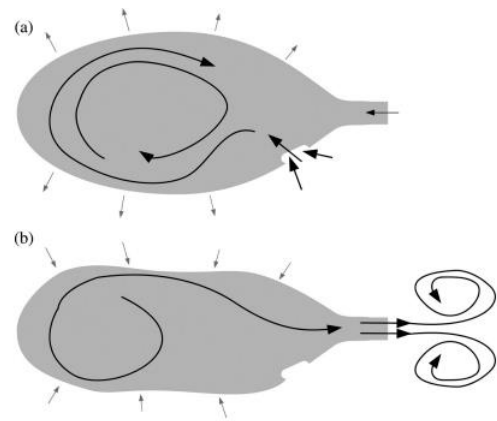

### REFILL PHASE

- mantle expansion
- refilling of the mantle cavity through water inlets

### JET PHASE

- mantle contraction
- expulsion of a fluid slug through the funnel (siphon)

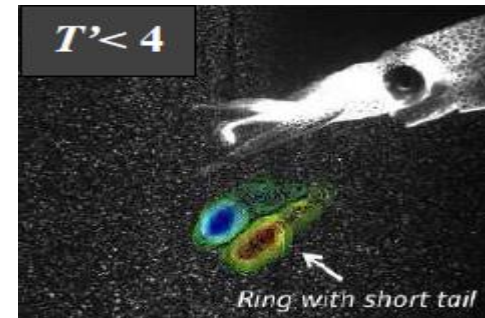
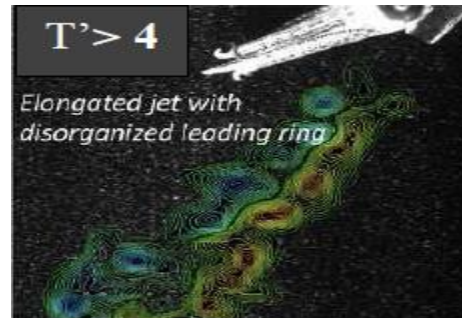

Ejection of a discontinuous stream of fluid through a nozzle that produces **ring vortexes**. The generation of ring vortexes provides an additional thrust to the one generated by a continuous jet, by generating an additional pressure at the nozzle orifice

The mantle and siphon **morphology** and the pulsed jet **frequency** optimize propulsion, producing **ring vortexes**



# Simplifying principles in swimming

## Pulsed-jet swimming soft robot

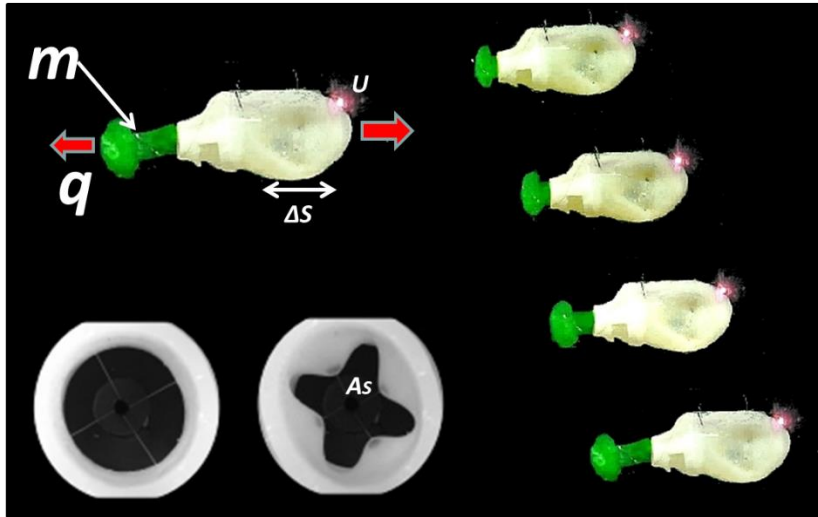

Silicone and cables, 1 DOF



PoseiDrone

The mantle and siphon **morphology** and the pulsed jet **frequency** optimize propulsion, producing ring vortexes (in green)



# Simplifying principles in underwater locomotion

## Octopus crawling



Locomotion is based on **cyclic** control of **two** back arms, while the body is raised thanks to **neutral buoyancy**. Locomotion consists of 4 phases:

1. Arm shortening
2. Attaching to the floor
3. Elongation (pushing the body forward)
4. Detaching

## U-SLIP model

Water drag, added mass, buoyancy and pushing propulsion have been added to the SLIP model

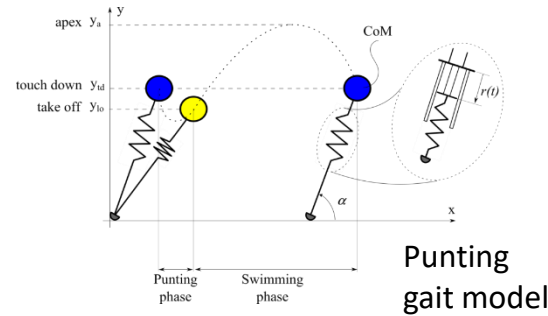

2 control parameters

4 design parameters

### Morphology-Induced Stability

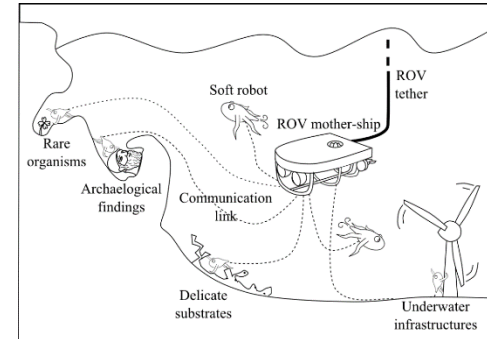
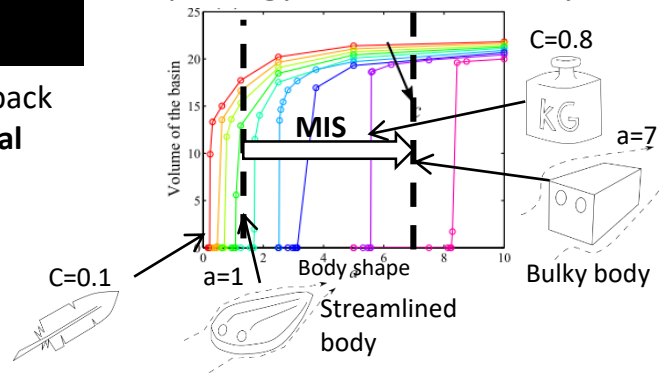

New concept of soft underwater robots

**Body matters: compliant legs or a soft body directly influence stability and speed**

Calisti, M., Giorelli, G., Levy, B., Mazzolai, B., Hochner, C., Laschi, P., Dario, "An octopus-bioinspired solution to movement and manipulation for soft robots", *Bioinspiration and Biomimetics* Vol.6, No.3, 2011, 10 pp.

Calisti, M., Corucci, F., Arienti, A., & Laschi, C. (2015). Dynamics of underwater legged locomotion: modeling and experiments on an octopus-inspired robot. *Bioinspiration & biomimetics*, 10(4), 046012.

Calisti, M., G. Picardi, and C. Laschi. "Fundamentals of soft robot locomotion." *Journal of The Royal Society Interface* 14.130



# Simplifying principles in squeezing

## Compliant articulate exoskeleton

Cockroaches intrude everywhere by exploiting their soft-bodied, shape-changing ability. They traversed horizontal crevices smaller than 25% of their height in less than 1s by compressing their bodies' compliant exoskeletons in half.



Soft, legged search-and-rescue robot that may penetrate rubble generated by tornados, earthquakes, or explosions.

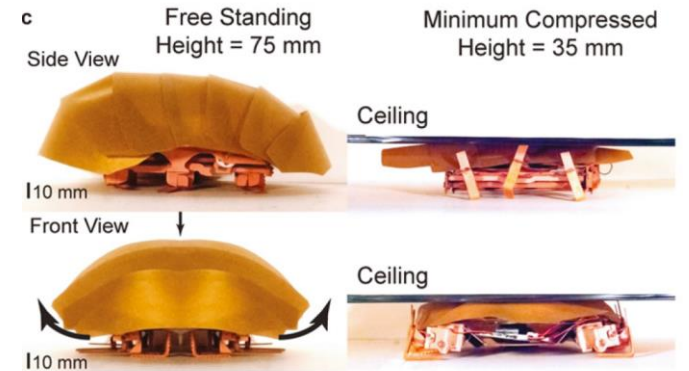

Compressible Robot with Articulated Mechanisms

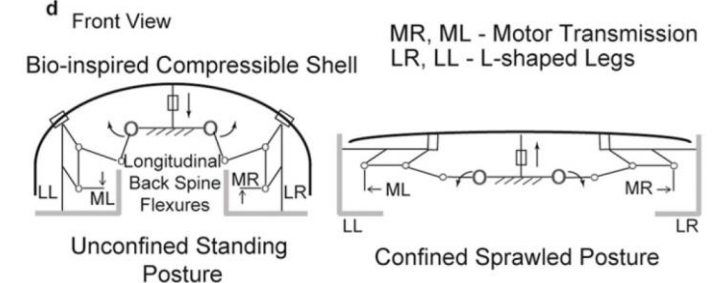

- Mechanical adaptation to available space
- 1 DOF

Once inside vertically confined spaces, cockroaches still locomoted rapidly at 20 body lengths per second using an unexplored mode of locomotion “body-friction legged crawling”.



# Embodied Intelligence and soft robotics

THE BIROBOTICS  
INSTITUTE



Scuola Superiore  
Sant'Anna

Any cognitive activity arises from the *interaction* between the body, the brain and the environment.

Adaptive behaviour is not just control and computation, but it emerges from the complex and dynamic interaction between the morphology of the body, sensory-motor control, and environment.

Many tasks become much easier if morphological computation is taken into account.

**=> A new soft bodyware is needed**

## Modern approach

The focus is on interaction with the environment. Cognition is emergent from system-environment interaction





# Defining Soft Robotics: a first broad classification

Scuola Superiore  
Sant'Anna

## Variable impedance actuators and stiffness control

- mechanically (or passively) compliant joints with variable stiffness
- compliance or impedance control

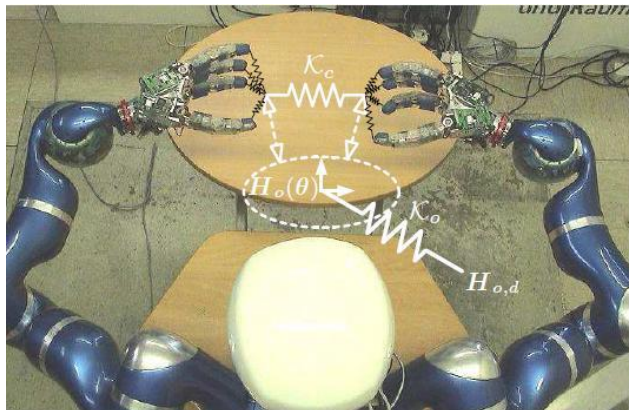

*IEEE Robotics and Automation Magazine*,  
Special Issue on Soft Robotics, 2008

## Use of soft materials in robotics

- Robots made of soft materials or structures that undergo high deformations in interaction
- Soft actuators and soft components

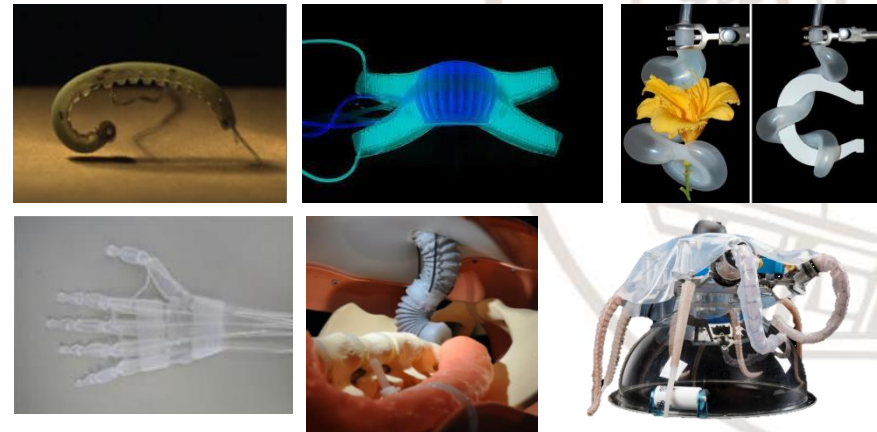

Laschi C. and Cianchetti M. (2014) "Soft Robotics: new perspectives for robot bodyware and control" *Frontiers in Bioengineering & Biotechnology*, 2(3)



# A 'soft' animal world

Scuola Superiore  
Sant'Anna

- The vast majority of animals are soft-bodied
- Animals with stiff exoskeletons such as insects have long-lived life stages wherein they are almost entirely soft (maggots, grubs, and caterpillars).
- Animals with stiff endoskeletons are mainly composed of soft tissues and liquids.



the human skeleton typically contributes only 11% of the body mass of an adult male

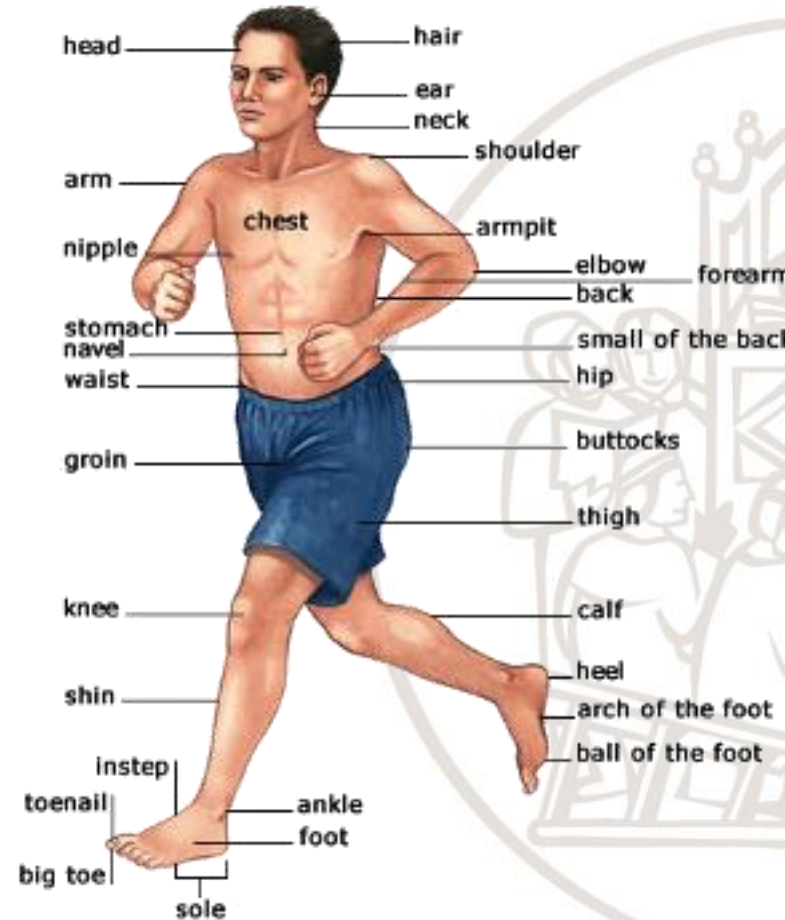

skeletal muscle contributes an average 42% of body mass



# A 'soft' animal world

- Soft animals tend to be **small** because it is difficult for them to support their own body weight without a skeleton.
- All of the extremely large soft invertebrates are found either
  - **in water** (squid and jellyfish) or
  - **underground** (giant earthworms), where their body is supported by the surrounding medium.



# Defining Soft Robotics

Shift from robots with rigid links to bio-inspired continuum robots that are “inherently compliant and exhibit large strains in normal operations”

Continuum robots: capable of bending via elastic deformation, and differing from traditional robots with rigid links and serpentine robots with a large number of short rigid links and degrees of freedom

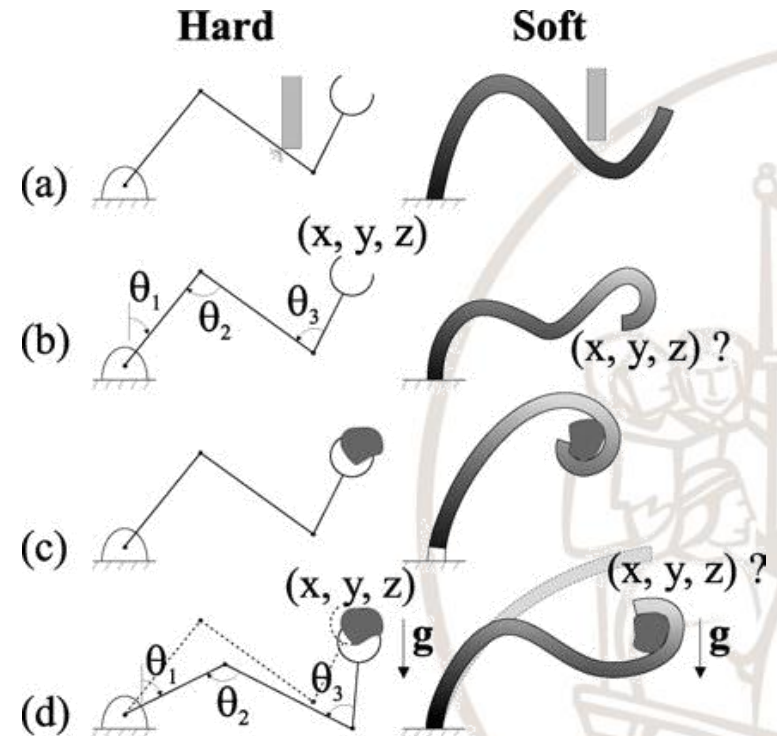
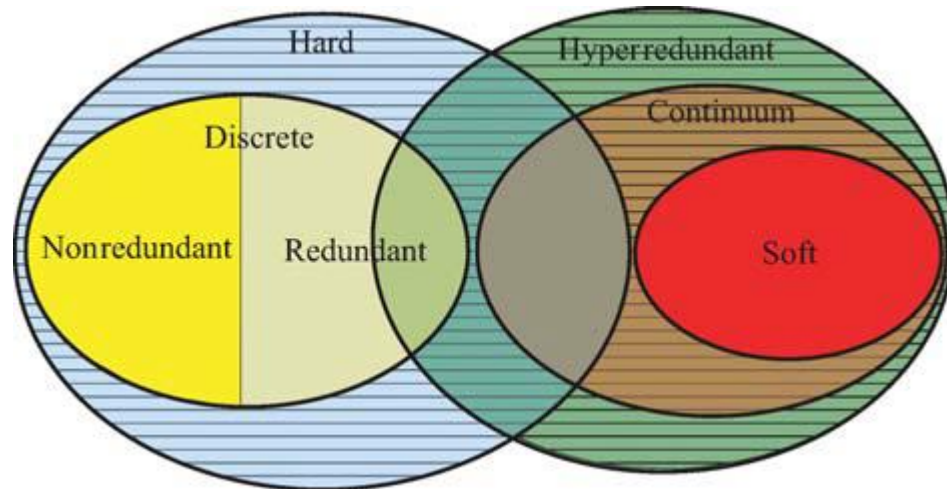

“soft robotic manipulators are continuum robots made of soft materials that undergo continuous elastic deformation and produce motion through the generation of a smooth backbone curve [15]”.

G. Robinson, J. B. C. Davies, “Continuum robots - a state of the art”, *IEEE International Conference on Robotics and Automation*, (Detroit, MI, 1999), pp. 2849-2854.

D. Trivedi, C. D. Rahn, W. M. Kier, I. D. Walker, “Soft robotics: Biological inspiration, state of the art, and future research”, *Applied Bionics and Biomechanics*, 5, 99-117 (2008)



# Defining Soft Robotics

- “Soft-bodied robots”, in analogy with soft-bodied animals

Kim S., Laschi C., and Trimmer B. (2013) Soft robotics: a bioinspired evolution in robotics, *Trends in Biotechnology*, April 2013.



- “Robots built with soft materials”

Laschi C. and Cianchetti M. (2014) “Soft Robotics: new perspectives for robot bodyware and control” *Frontiers in Bioengineering & Biotechnology*, 2(3)



- “systems that are capable of autonomous behavior, and that are primarily composed of materials with moduli in the range of that of soft biological materials”

D. Rus, M. T. Tolley, Design, fabrication and control of soft robots. *Nature* 521, 467-475 (2015).

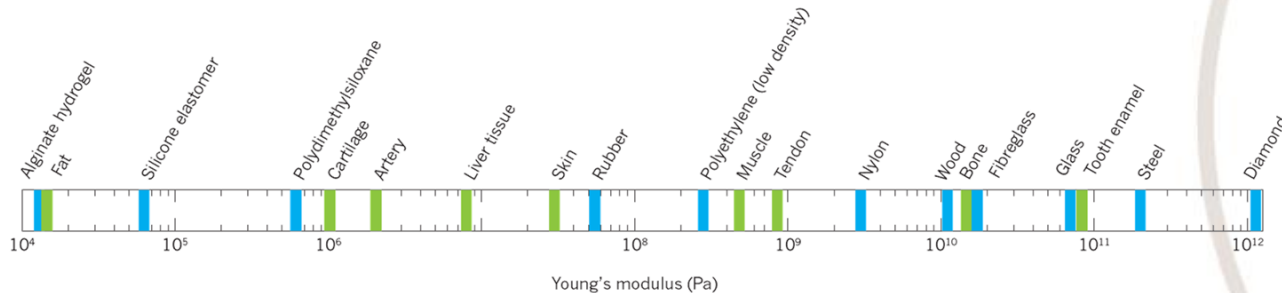

Figure 2 | Approximate tensile modulus (Young's modulus) of selected engineering and biological materials. Soft robots are composed primarily of materials with moduli comparable with those of soft biological materials (muscles, skin, cartilage, and so on), or of less than around 1 gigapascal. These materials exhibit considerable compliance under normal loading conditions.

- “soft-matter robotics”, based on the well-known concept of “soft matter” used for materials

L. Wang, F. Iida, Deformation in Soft-Matter Robotics: A Categorization and Quantitative Characterization. *IEEE Robotics & Automation Magazine* 22(3), 125-139 (2015).

# Defining Soft Robotics



First RoboSoft Working Paper – September 2014

On the basis of the above statements, the RoboSoft community proposed and agreed on the following definition of Soft Robotics:

*“Soft robot/devices that can actively interact with the environment and can undergo ‘large’ deformations relying on inherent or structural compliance”*

Definition of Soft Robotics by RoboSoft Community

RoboSoft is a Coordination Action on Soft Robotics funded by the European Commission. The RoboSoft Community accounts for 34 member institutions for a total of 100+ scientists

***“Soft robot/devices that can actively interact with the environment and can undergo ‘large’ deformations relying on inherent or structural compliance”***

Soft Robotics may exploit materials which present:

- INHERENT MATERIAL compliance: bulk material properties (elastomers, low elastic modulus polymers, gels...)



M. Wehner, R.L. Truby, D.J. Fitzgerald, B. Mosadegh, G.M. Whitesides, J.A. Lewis, R.J. Wood, An integrated design and fabrication strategy for entirely soft, autonomous robots, *Nature* 536, 451–455

- STRUCTURAL compliance: geometric features or arrangement can allow magnified strains compared with local material deformation

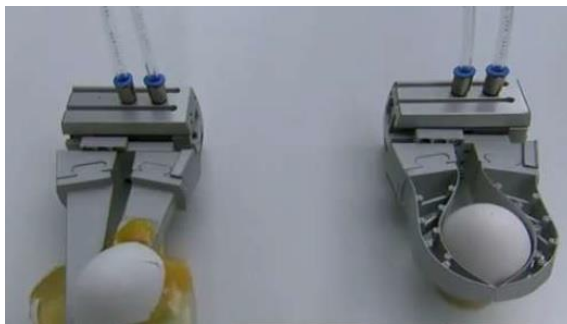

Low Elastic Modulus

→ Soft Robotics

High Elastic Modulus

→ Hard Robotics

**Geometry**







# Summary of bioinspired approaches to robotics (in this course...)

Scuola Superiore  
Sant'Anna

Robot vision

Robot sensors

Robot mechanics  
and kinematics

Robot control

Robot behaviour

Robot navigation

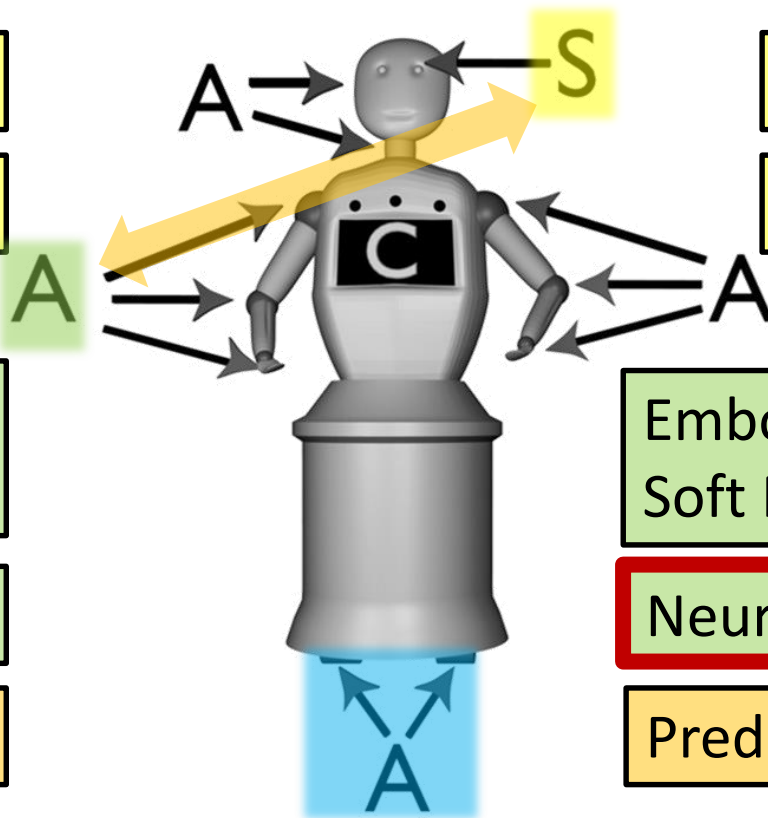

Bioinspired vision

Vestibular system

Embodied Intelligence,  
Soft Robotics

Neurocontrollers

Predictive behaviour

Bioinspired navigation,  
Soft locomotion



# Motor control: model-based closed-loop schemes for controlling arm position and orientation

- A priori knowledge on the geometry, kinematics and dynamics of the robot is required
- High computational complexity
- Little flexibility and generalization
- High accuracy

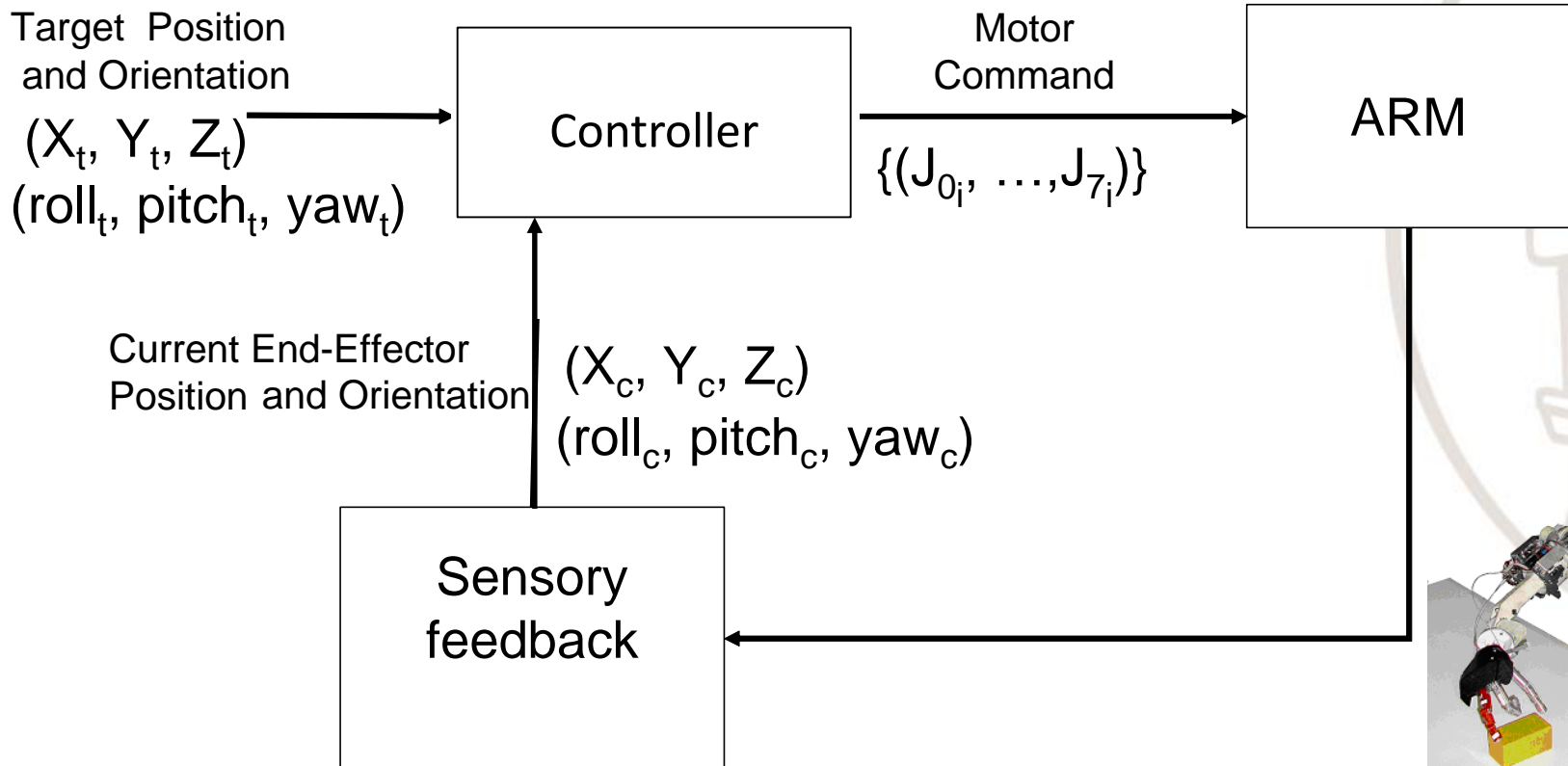



# Learning motor control: neurocontroller for controlling arm position and orientation

Scuola Superiore  
Sant'Anna

- No a priori knowledge on the geometry, kinematics and dynamics of the robot is required
- **learning** capability, to develop an internal model that builds such knowledge
- low computational complexity
- human-like flexibility, robustness, generalization

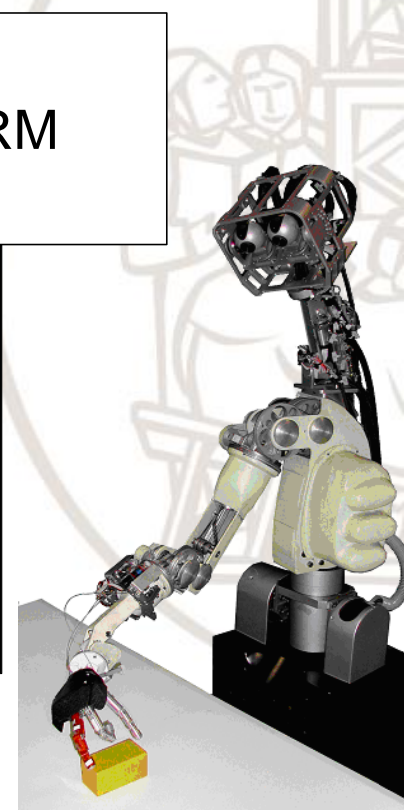
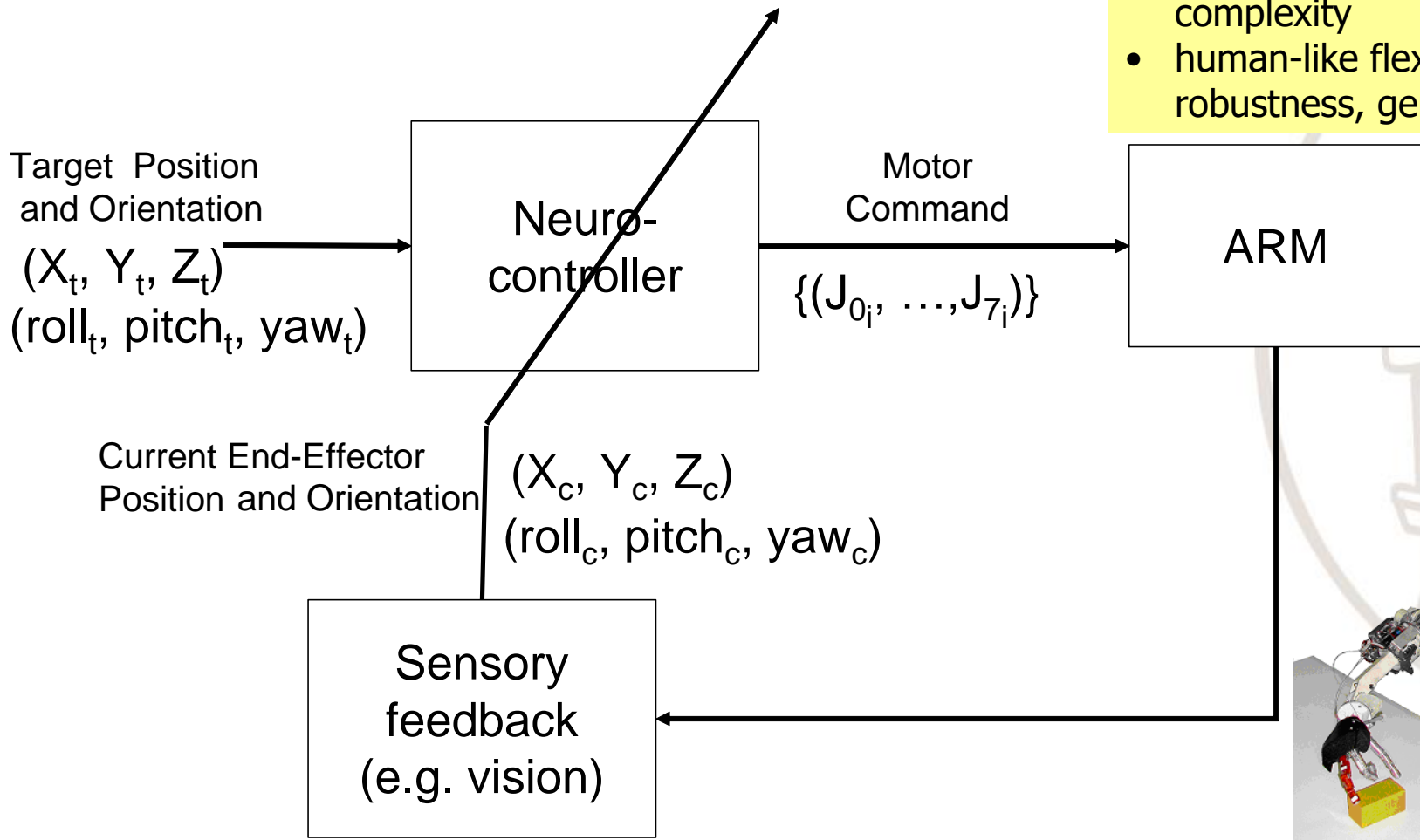



# Application of the same approach to different robotic systems

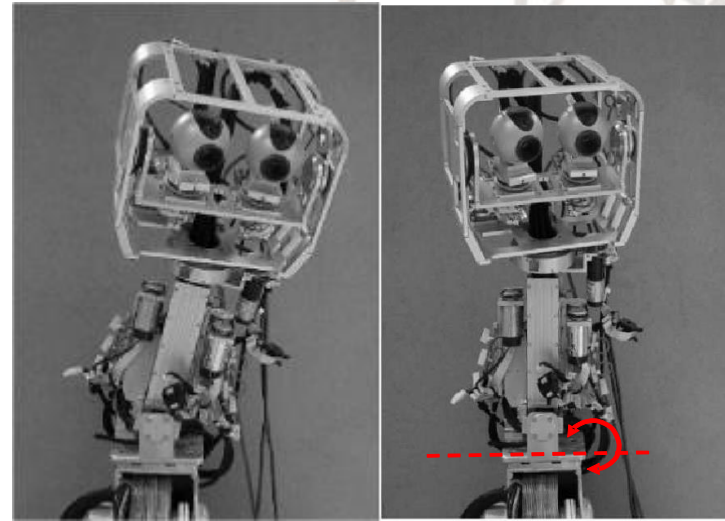
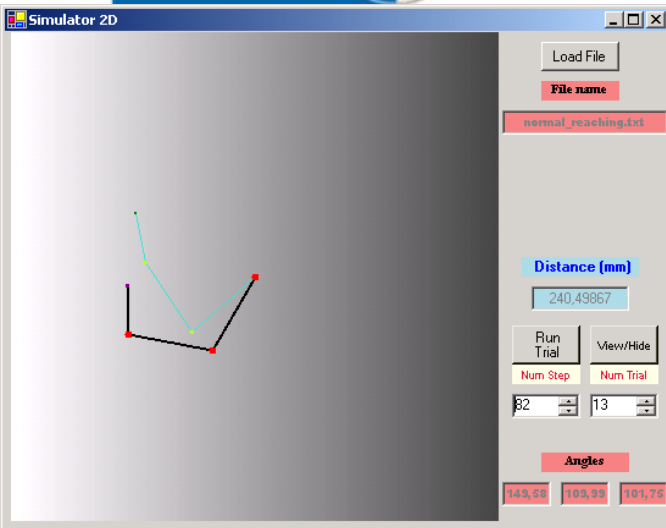

G. Asuni, Leoni F., Starita A., Guglielmelli E., Dario P., "A Neuro-controller for Robot Arms Based on Biologically-Inspired Visuo-Motor Coordination Neural Models", *The 1st International IEEE EMBS Conference on Neural Engineering*, 20 - 22 March, 2003, Capri Island, Italy.

E. Guglielmelli G. Asuni, F. Leoni, A. Starita, P. Dario, "A Neuro-controller for Robot Arms Based on Biologically-Inspired Visuo-Motor Co-ordination Neural Models", *IEEE Handbook of Neural Engineering*, M. Akay (Ed.), IEEE Press, 2007.

G. Asuni, G. Teti, C. Laschi, E. Guglielmelli, P. Dario, "A Robotic Head Neuro-controller on Biologically-Inspired Neural Models", *IEEE International Conference on Robotics and Automation* April 18-22, 2005, Barcelona, Spain

# Soft robot control

FROM:

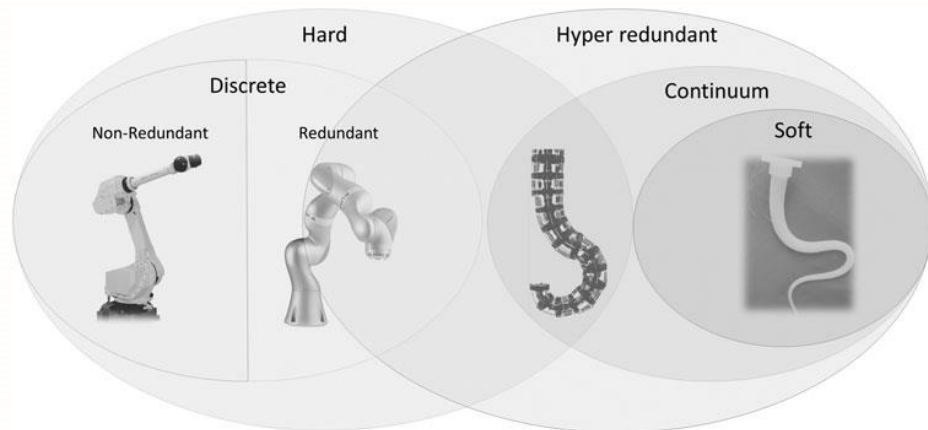
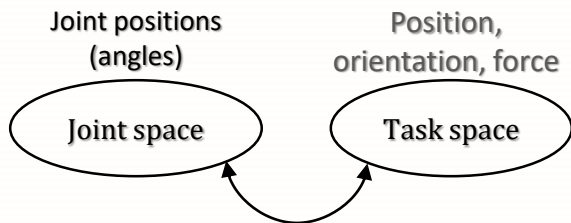

TO:

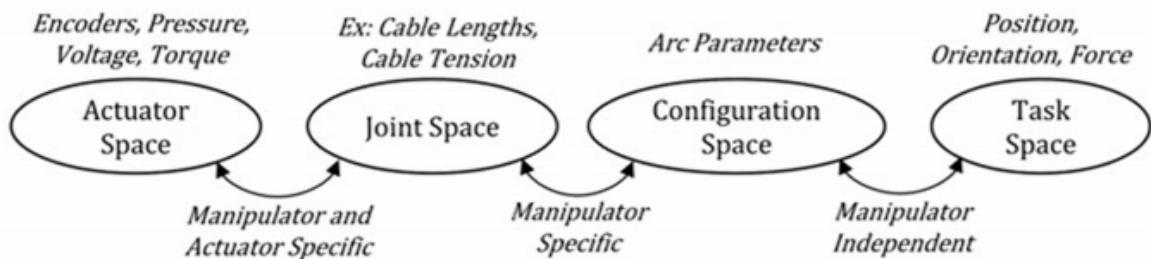

Model-based Approaches

Model-Free (learning-based) approaches



# Model-based approaches for soft robot control

Continuous-functions

**Constant Curvature Model**

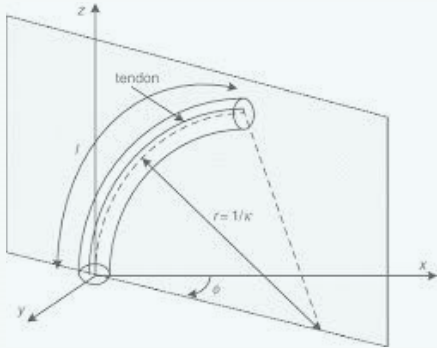

**Piecewise Constant Curvature**

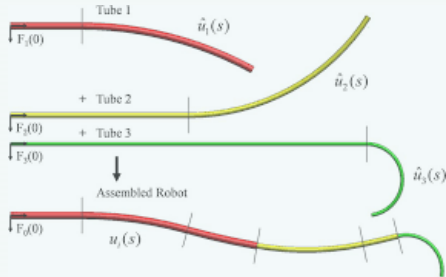

Discretized-functions

**Cosserat-Rod Model**

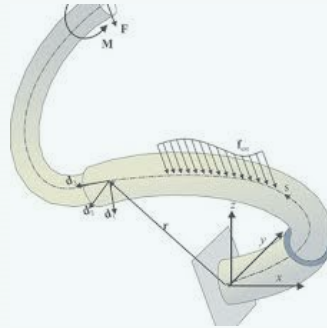

**Lumped-Parameter Model**

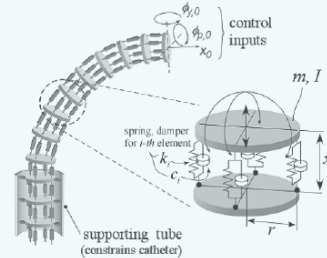

Finite Element Method

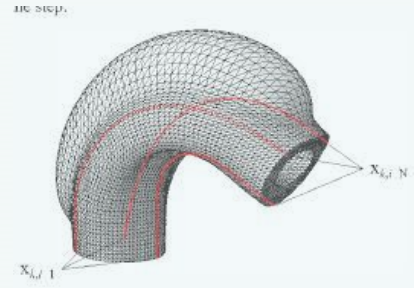

Increasing Computational Complexity and 'Accuracy' ➔



# Model-based approaches for soft robot control

## Based on CC modeling

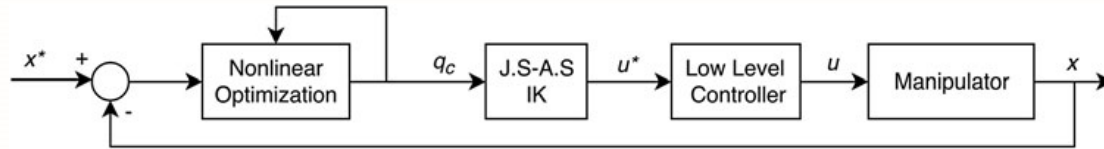
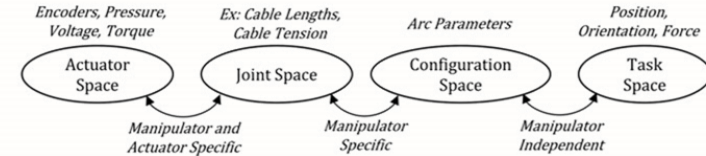

Closed-loop task space controller

Camarillo DB, Carlson CR, Salisbury JK. Task-space control of continuum manipulators with coupled tendon drive. In: *Experimental Robotics. Springer Tracts in Advanced Robotics*, vol 54. Khatib O, Kumar V, Pappas GJ (Eds). Berlin, Heidelberg; Springer: 2009, pp. 271–280.

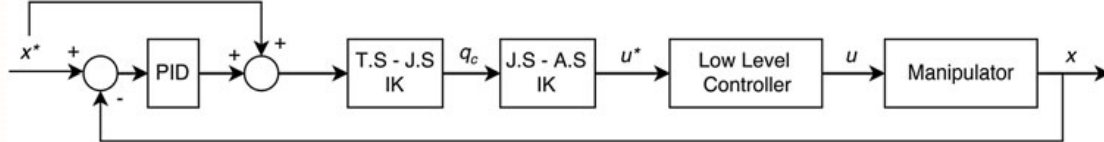

Closed-loop controller in task space

Bajo A, Goldman R, Simaan N. Configuration and joint feedback for enhanced performance of multi-segment continuum robots. *2011 IEEE International Conference on Robotics and Automation (ICRA)*, Shanghai, China, 2011.

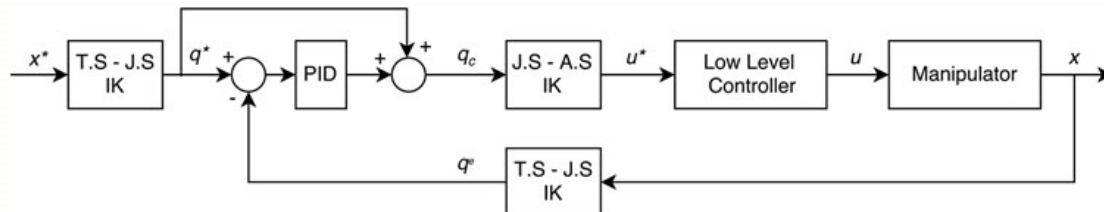

Closed-loop controller in joint space

PenningR, Jung J, Ferrier N, Zinn M. An evaluation of closedloop control options for continuum manipulators. *2012 IEEE International Conference on Robotics and Automation (ICRA)*, Saint Paul, MN, 2012.



# Model-based approaches for soft robot control

## Discussion:

- Most widely used in quasi static conditions
- Mostly relying on CC approximation
- More complex models are computationally expensive
- Need for alternative methods, better addressing the complexity of soft robot control, at affordable computational cost

**=> model-free approaches**

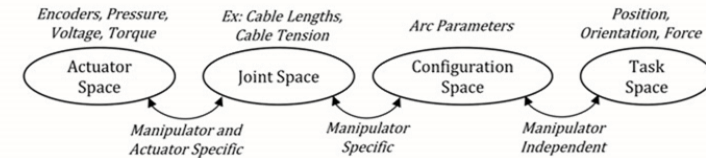



# Model-free approaches for soft robot control

Supervised-learning

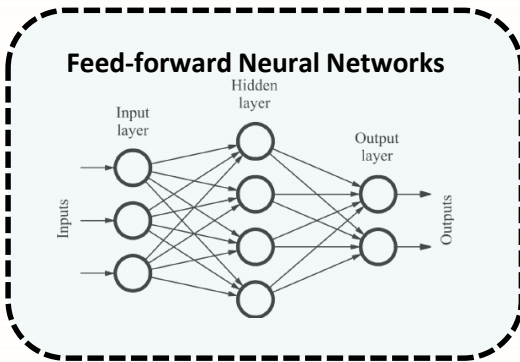

Unsupervised Learning

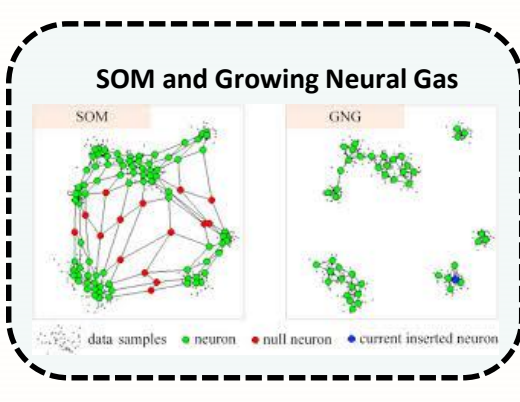

Reservoir computing

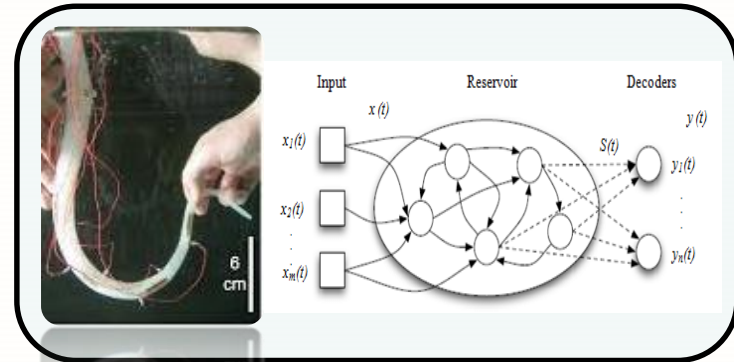

Reinforcement Learning

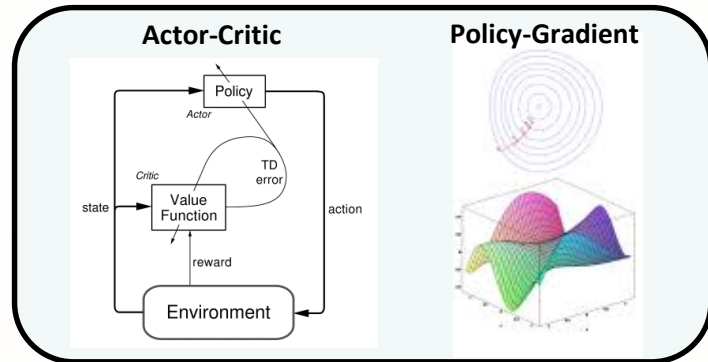

# Model-free approaches for soft robot control

## Model-free closed-loop task space controller

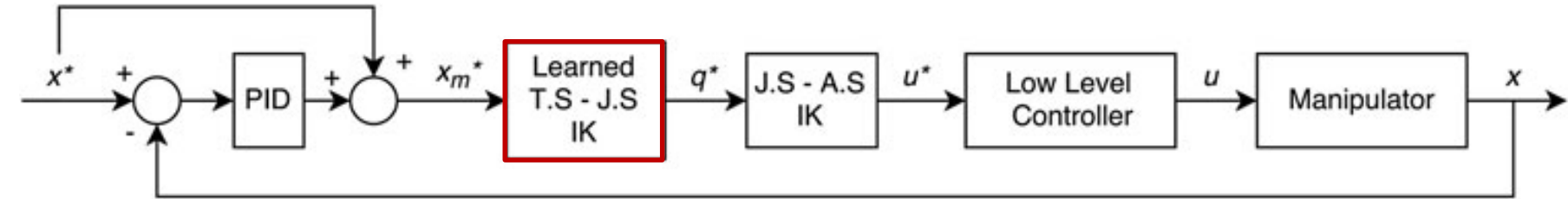
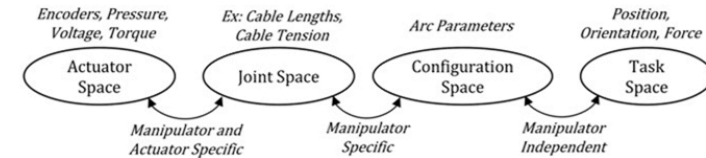

Rolf M, Steil JJ. Efficient exploratory learning of inverse kinematics on a bionic elephant trunk. *IEEE Trans Neural Netw Learn Syst* 2014;25:1147–1160.

Learning-based Control, by learning the inverse model.

Learning by collecting points and exploiting the approximation capability of a FNN, as for rigid robots

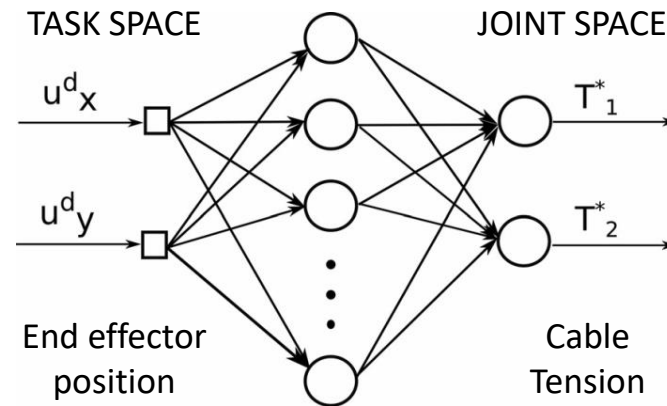

Giorelli M, Renda F, Calisti M, Arienti A, Ferri G, Laschi C. Neural network and Jacobian method for solving the inverse statics of a cable-driven soft arm with nonconstant curvature. *IEEE Trans Robot* 2015;31:823–834.

Giorelli M, Renda F, Calisti M, Arienti A, Ferri G, Laschi C. Learning the inverse kinetics of an octopus-like manipulator in three-dimensional space. *Bioinspir Biomim* 2015; 10:035006.

# Model-free approaches for soft robot control

## Discussion:

- No need for defining the parameters of the configuration space or joint space
- Independent from manipulator shape
- Arbitrarily complex kinematic models, depending on sample data and sensory noise
- Better performance with highly nonlinear, non-uniform, gravity-influenced systems
- Suitable for unstructured environments where modelling is almost impossible

**Better encoding of morphological computation?**

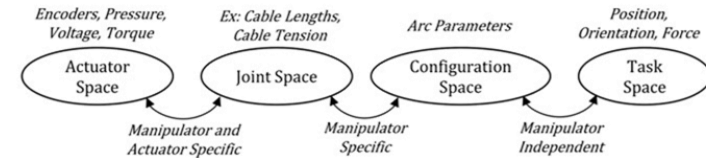



# Summary of bioinspired approaches to robotics (in this course...)

Scuola Superiore  
Sant'Anna

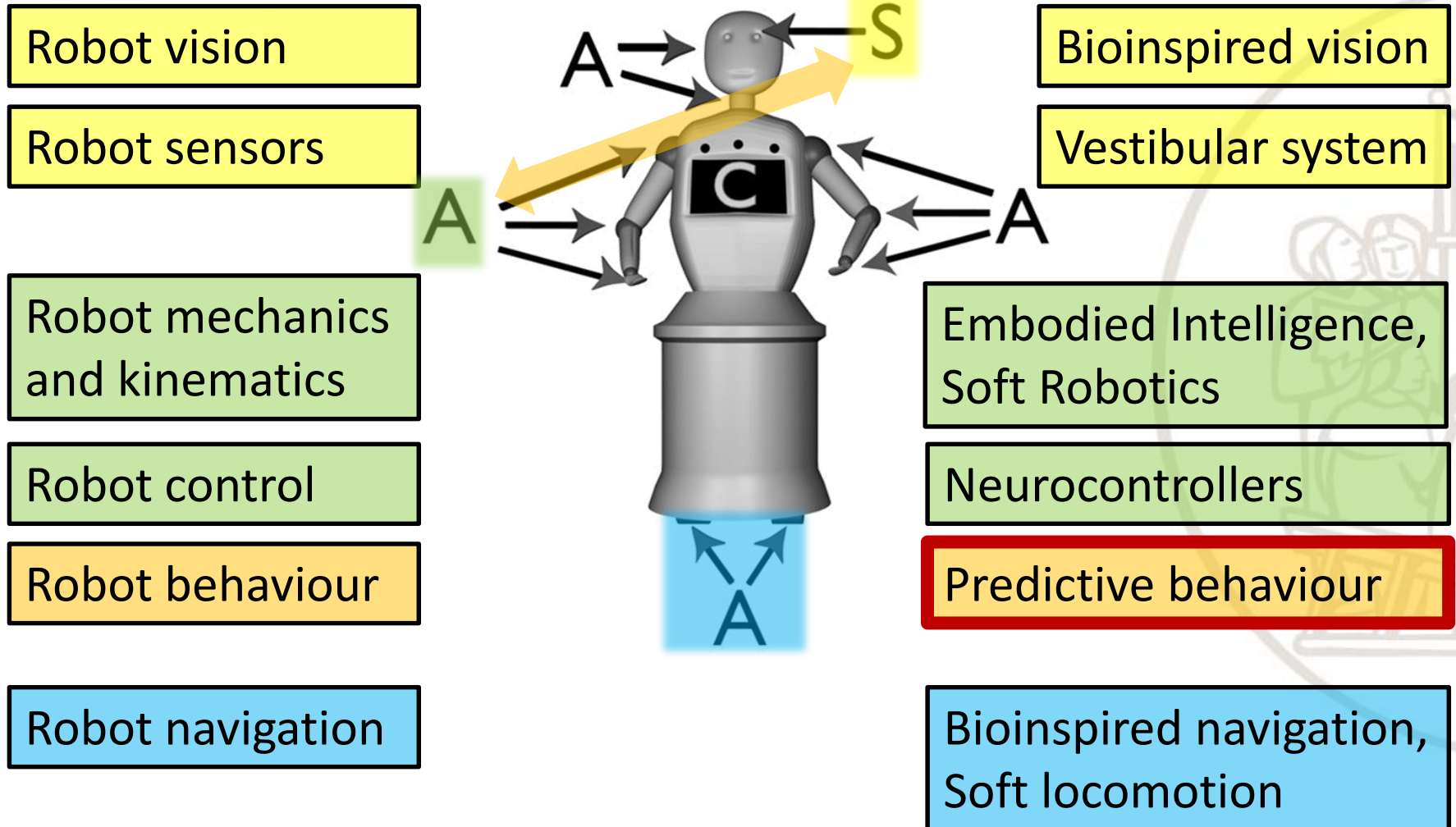

# Prediction and anticipation strategies in the human brain

In humans, perception is not just the interpretation of sensory signals, but a prediction of consequences of actions

“Perception can be defined as a *simulated action*: perceptual activity is not confined to the interpretation of sensory information but it **anticipates** the consequences of action, so it is an internal simulation of action.

Each time it is engaged in an **action**, the brain constructs hypotheses about the state of a variegated group of **sensory** parameters throughout the movement.”



# From hierarchical to reactive architectures in robotics

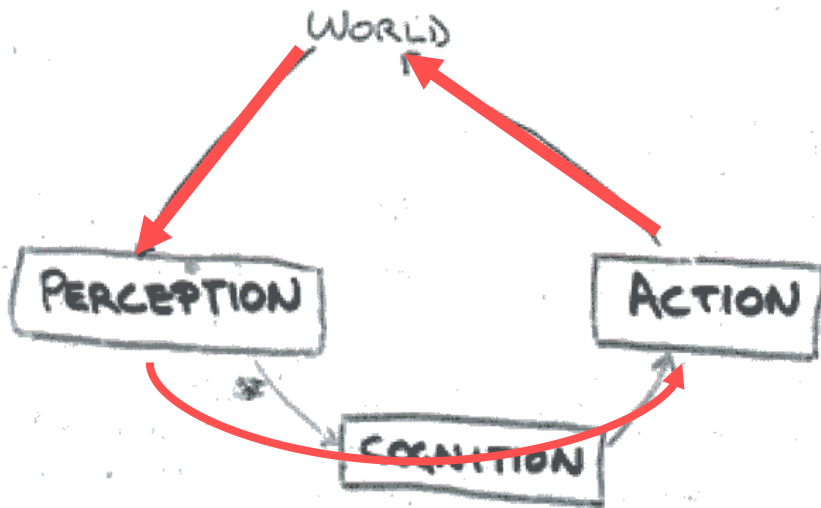

**Figure 1:** The traditional model where cognition mediates between perceptions and plans of actions.

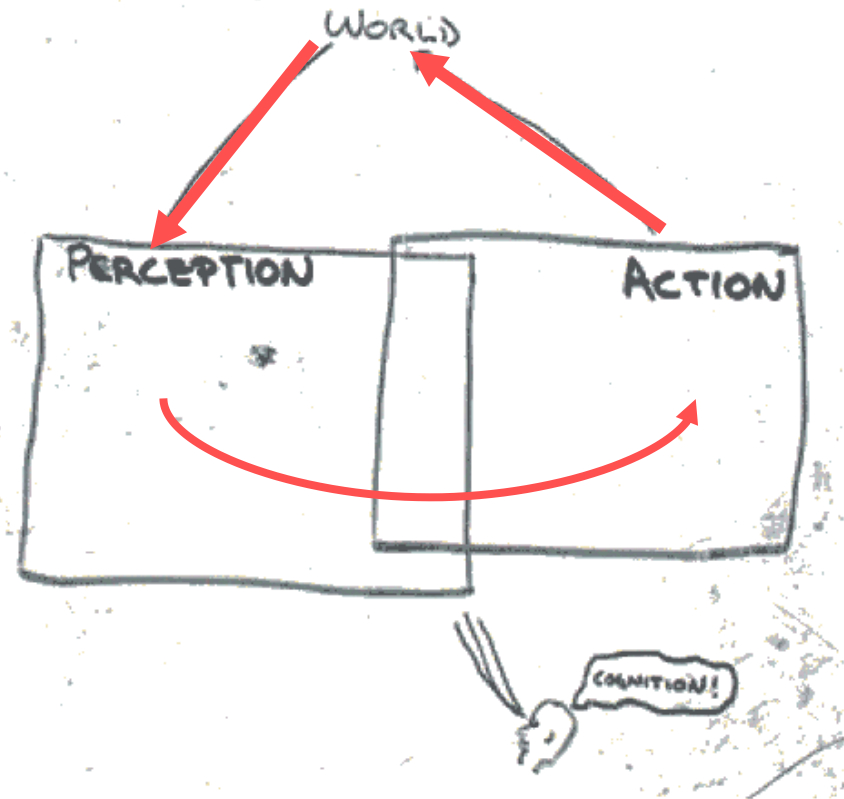

**Figure 2:** The new model, where the perceptual and action subsystems are all there really is. Cognition is only in the eye of an observer.



# Predictive architectures

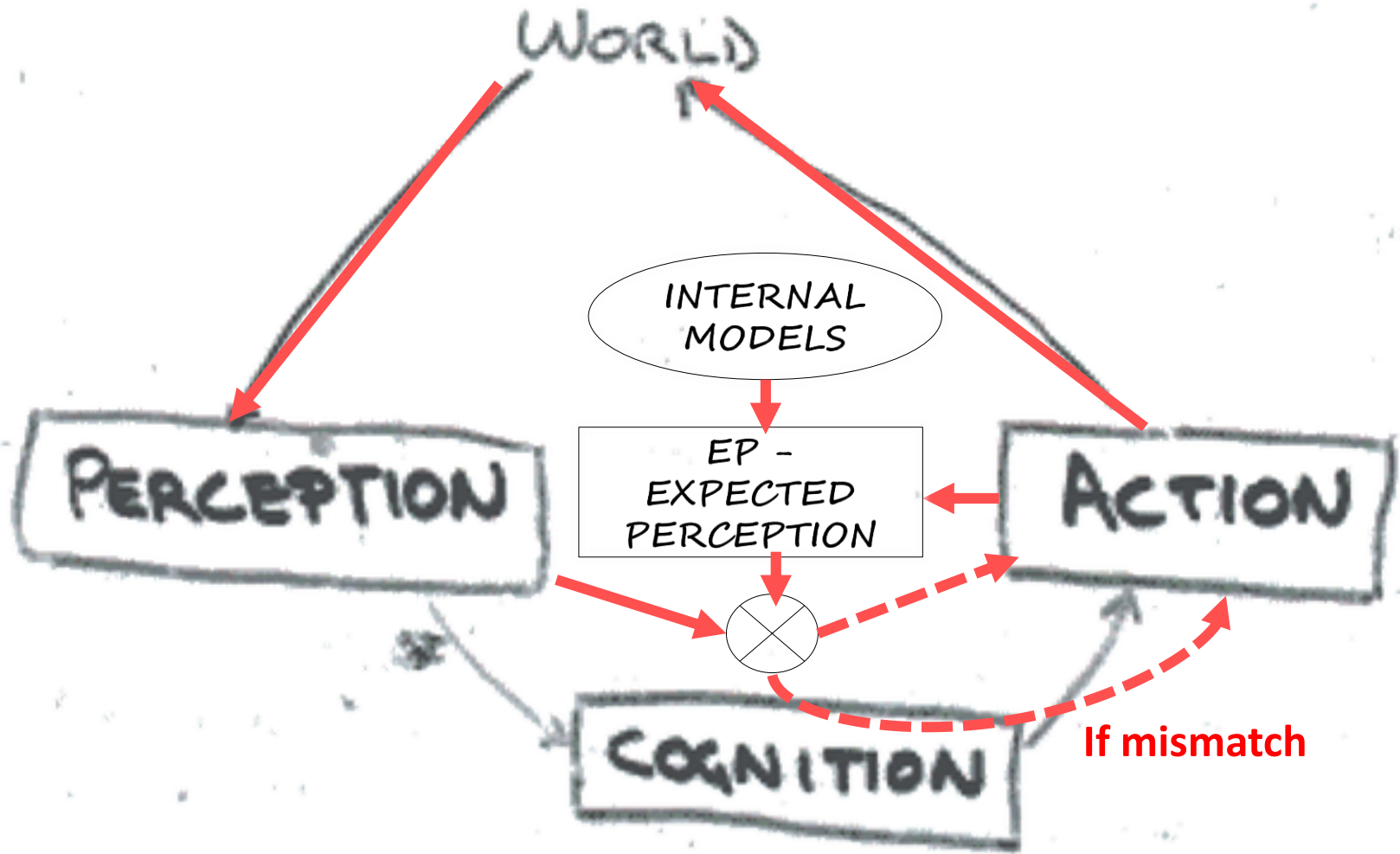

# Hierarchical architectures

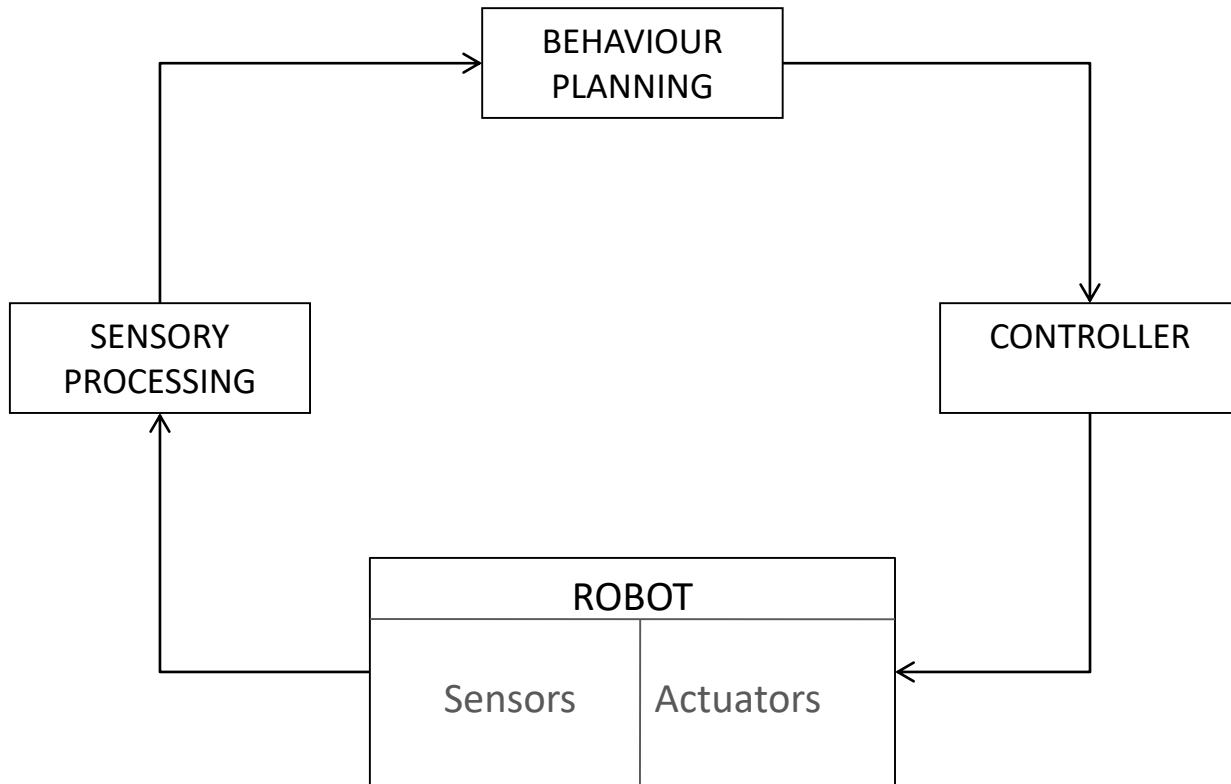



# Reactive architectures

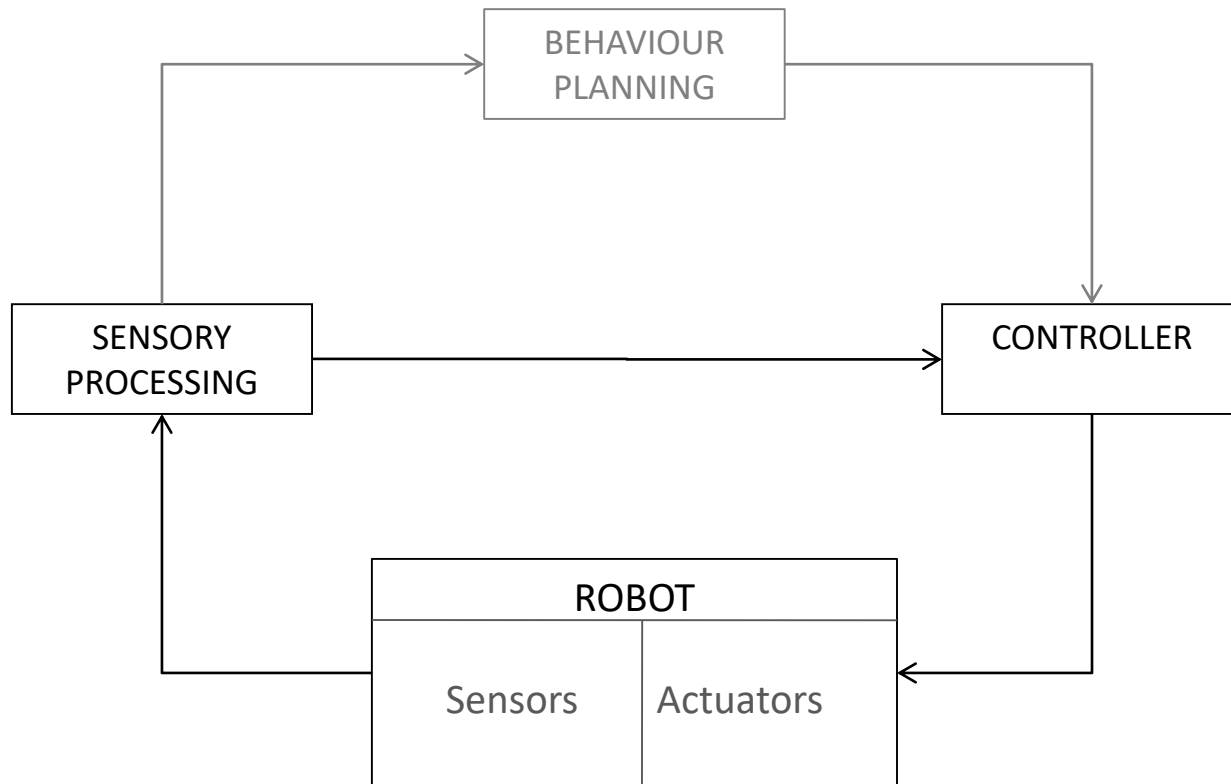

# Expected Perception (EP) System

## Expected Perception:

- Internal Model to predict the robot perceptions
- Comparison between actual and predicted perception
- **Open loop** controller if the prediction error is low
- **Closed loop** controller if the prediction error is high

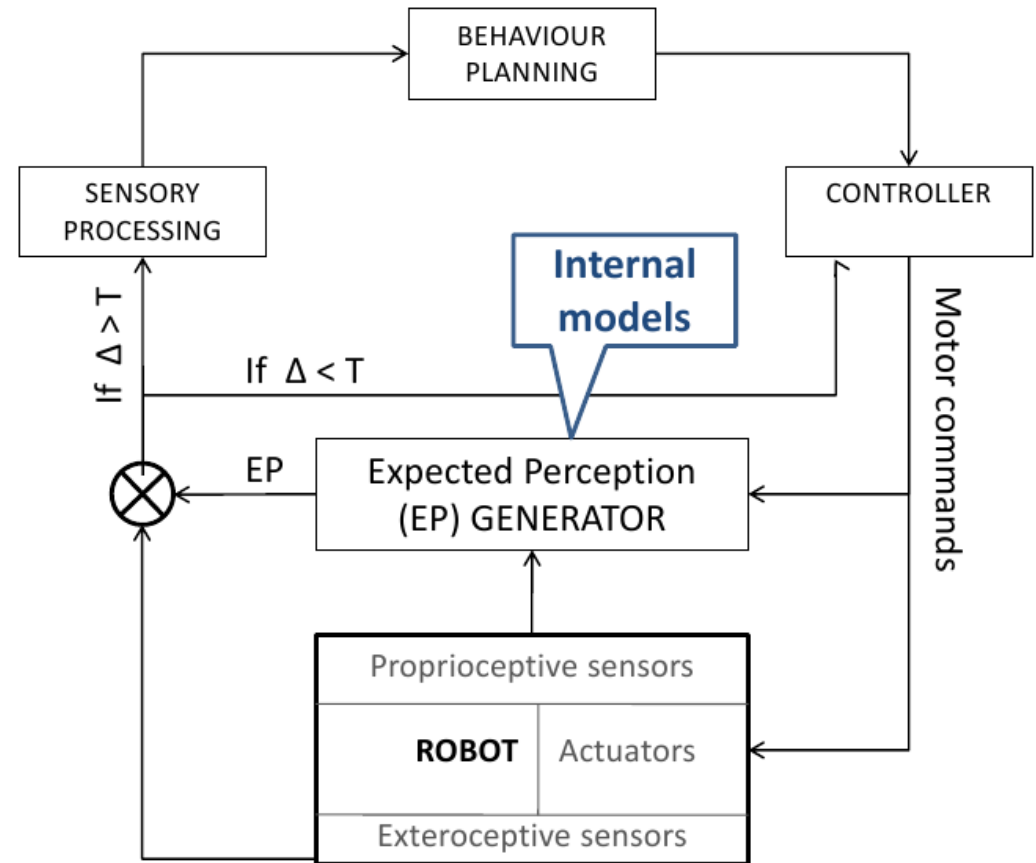

# Sensory prediction proposed by R. Johansson

“Because of the long time delays with feedback control the swift coordination of fingertip forces during self-paced everyday manipulation of ordinary ‘passive’ objects must be explained by other mechanisms. **Indeed, the brain relies on feedforward control mechanisms and takes advantage of the stable and predictable physical properties of these objects by parametrically adapting force motor commands to the relevant physical properties of the target object.**”

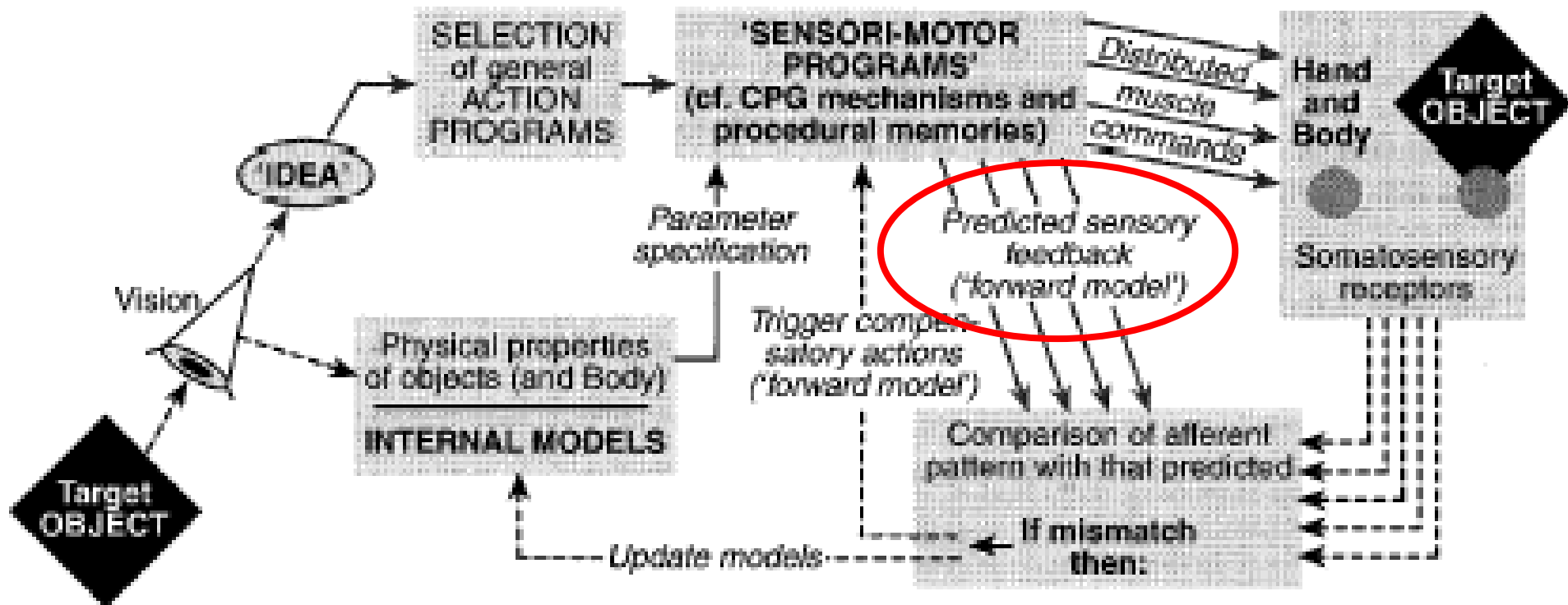

Corrections are generated when expected sensory inputs do not match the actual ones



# Learning of grasping module

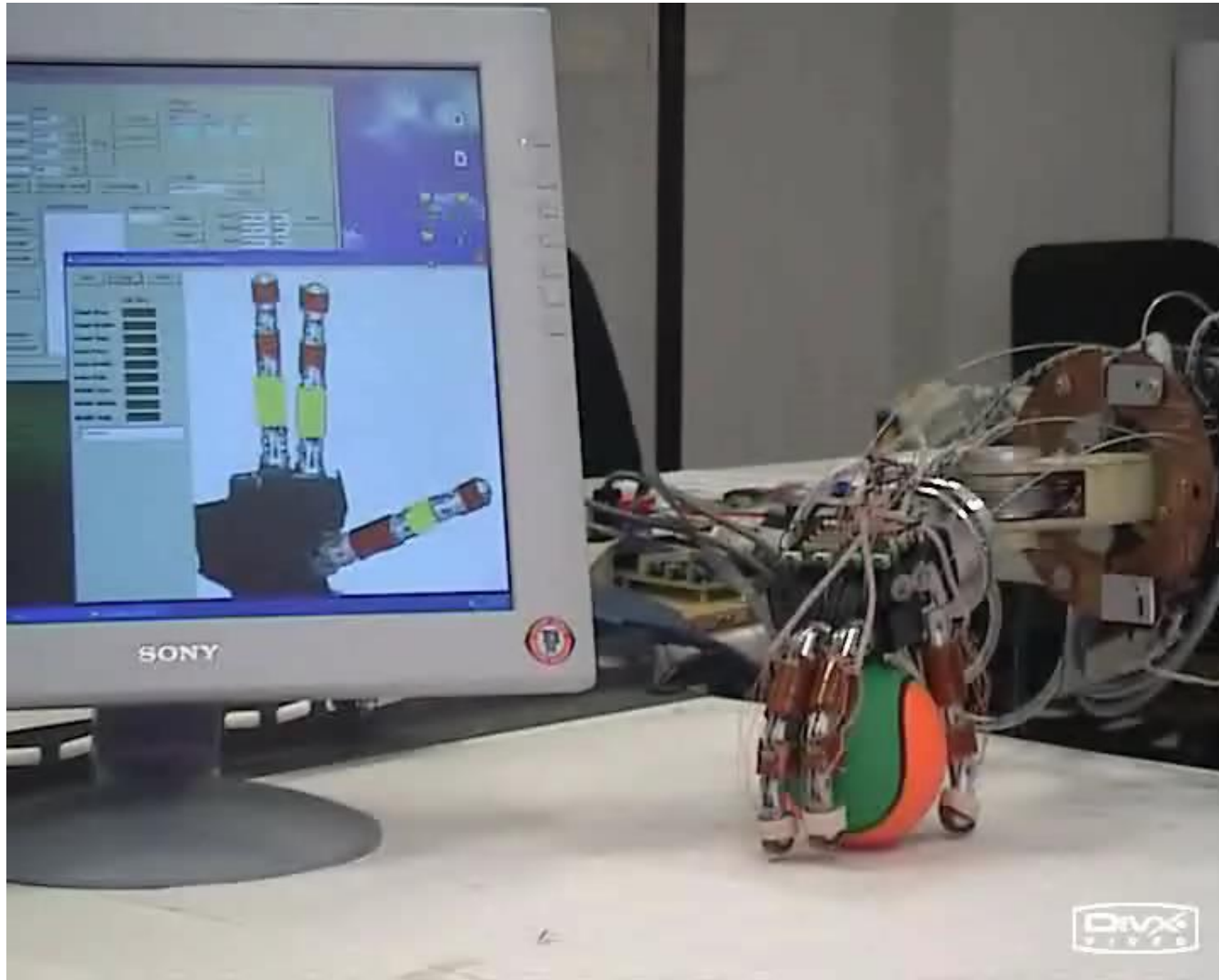

Learning phase:  
About 40000 random movements



# Grasping the bottle

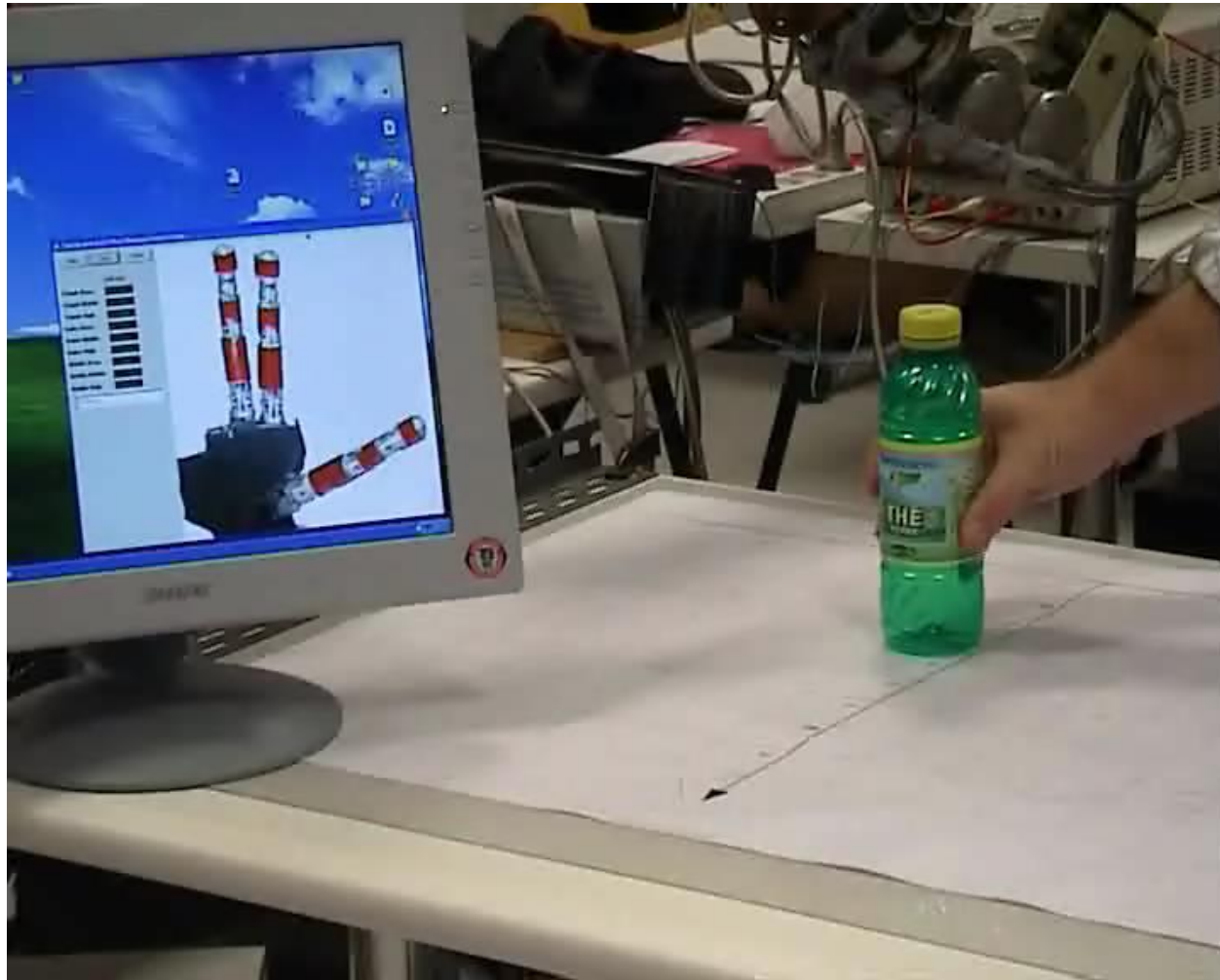

C. Laschi, G. Asuni, E. Guglielmelli, G. Teti, R. Johansson, M.C. Carrozza, P. Dario, "A Bio-inspired Neural Sensory-Motor Coordination Scheme for Robot Reaching and Preshaping", *Autonomous Robots*, Vol.5, 2008, pp.85-101.



# Expected Perception in the visual space

EP architecture applied to 3D reconstruction of the environment



Task: free walking in an unknown room with obstacles

Classical approach:

- 3D reconstruction of the environment
- path planning for collision-free walking
- > large computational burden

In a Visual EP architecture, after a first 3D reconstruction of the environment, images can be predicted, based on internal models and on the ongoing movement.

Predicted images are compared with actual ones and in case of unexpected obstacles a mismatch occurs and the motor action is re-planned



# Visual EP scheme

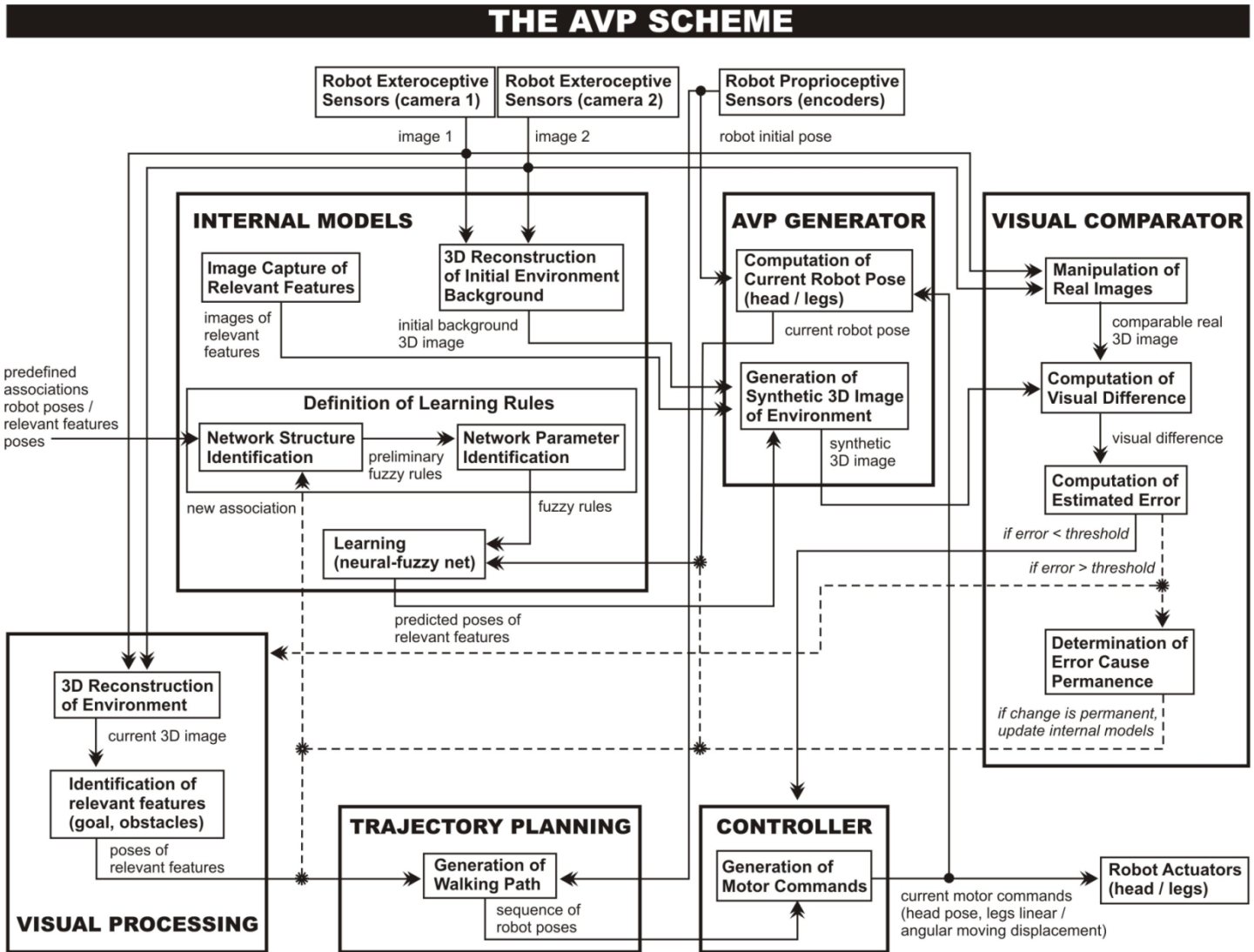

# AVP architecture (I)

- **Visual Processing** module takes as input current images from both robot cameras to reconstruct the environment producing the **relevant feature position**.
- The poses of relevant features are sent to a **Trajectory Planning** module to generate the walking path
- The **Controller** module then takes the first robot pose from the sequence of poses planned by the Trajectory Planning module and produces the corresponding motor commands
- This cycle continues until the robot reaches the target.

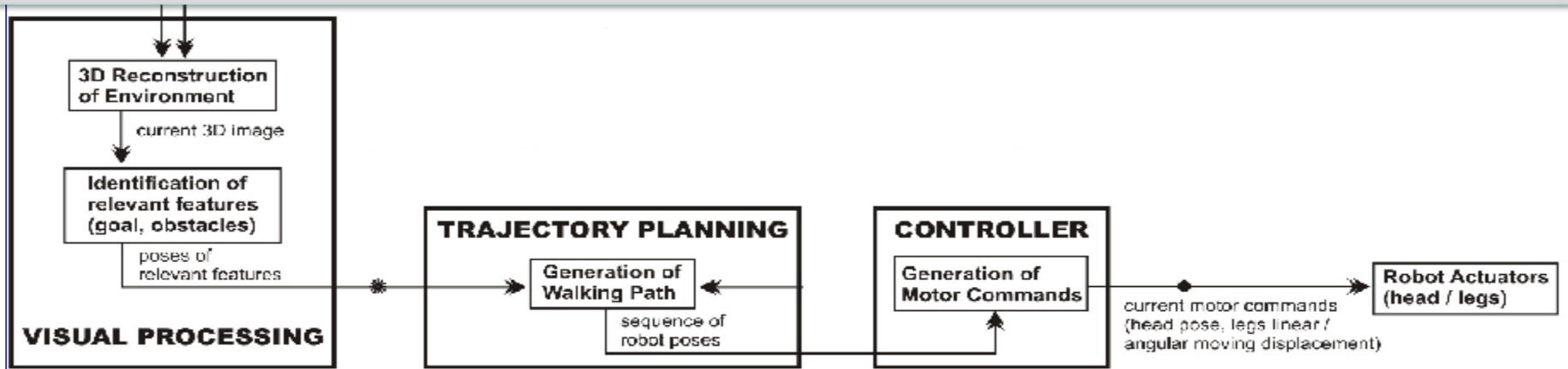



# AVP architecture (II)

- **Internal Models** of the environment and of the task to be performed are necessary to *predict future visual perceptions*.

- Images of different features relevant to the locomotion task are captured and memorized

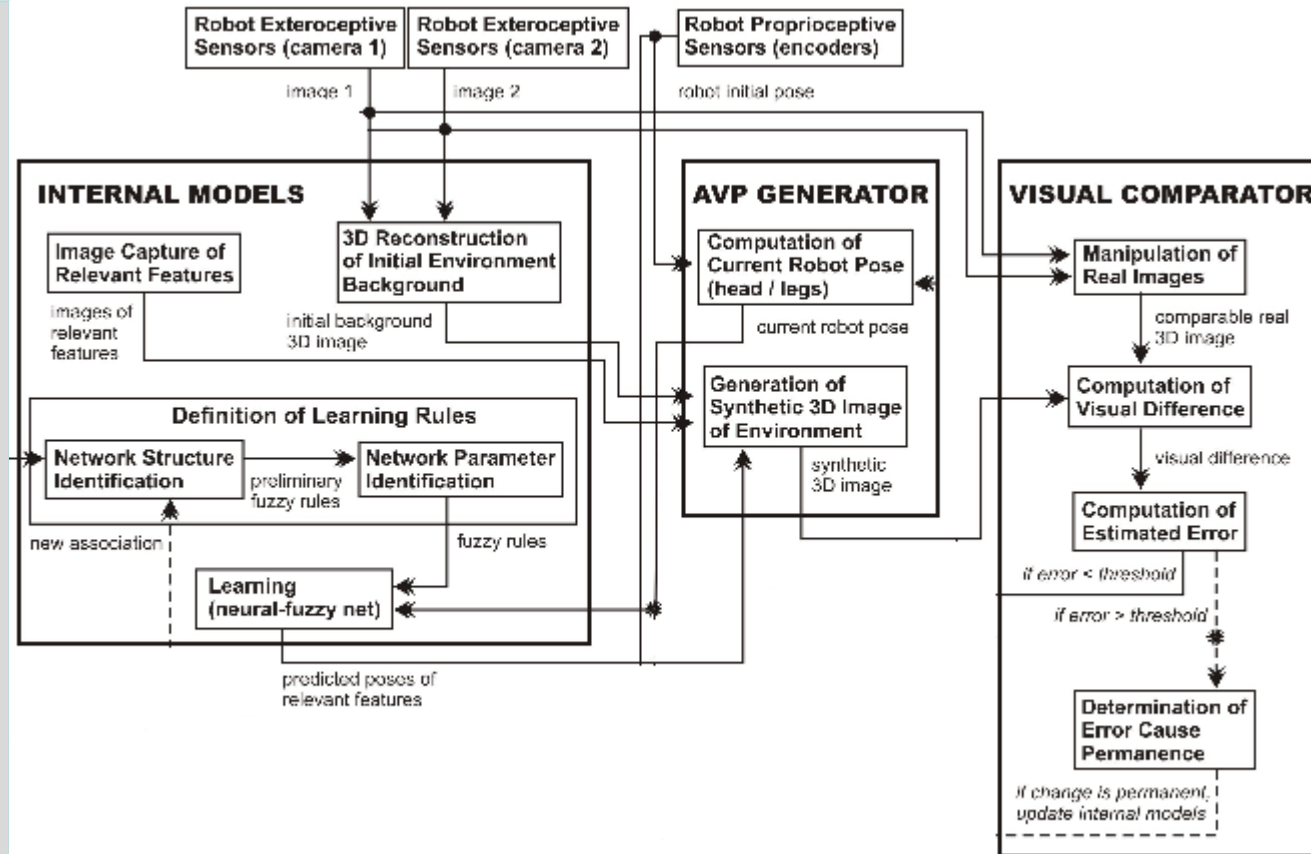

# Visual EP System (implementation)

The system performs a real time 3D reconstruction of the environment (30fps) used to generate an **expected synthetic camera image**. The cloud of 3D points is updated using an image sensory-motor prediction.

At each step:

- the next predicted image (EP) is calculated.
- the predicted and actual camera images are compared.
- the 3D reconstruction of the visible environment is updated based on the prediction error

The system has 2 advantages:

- A faster real-time 3D reconstruction
- Recognition of the unexpected objects in the scene

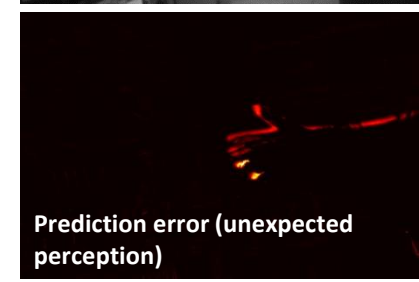
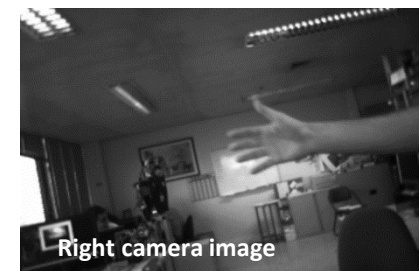
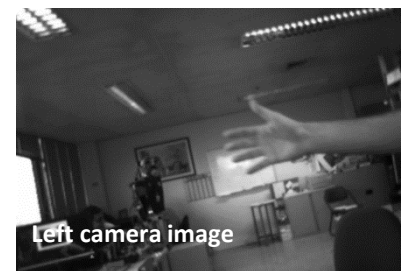
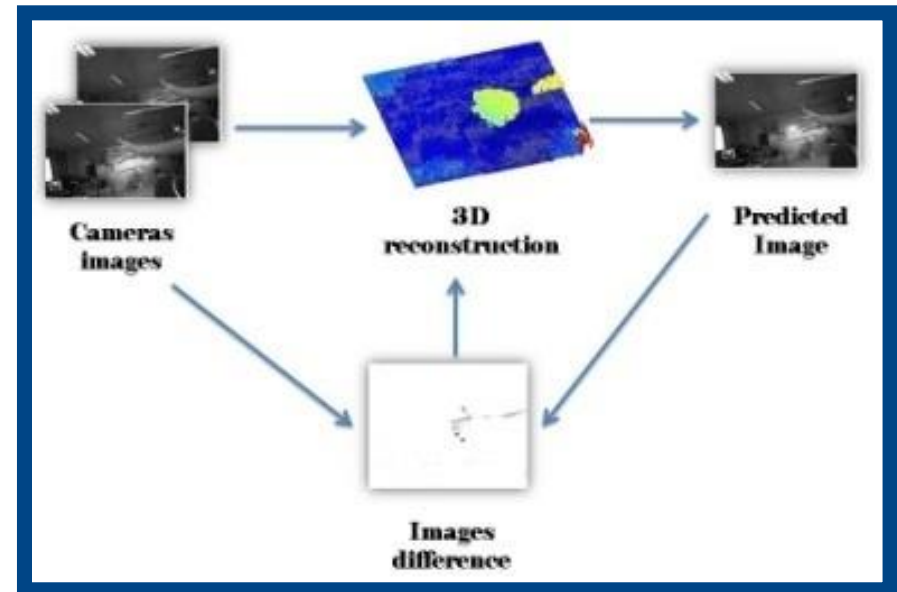

# A predictive model for smooth pursuit

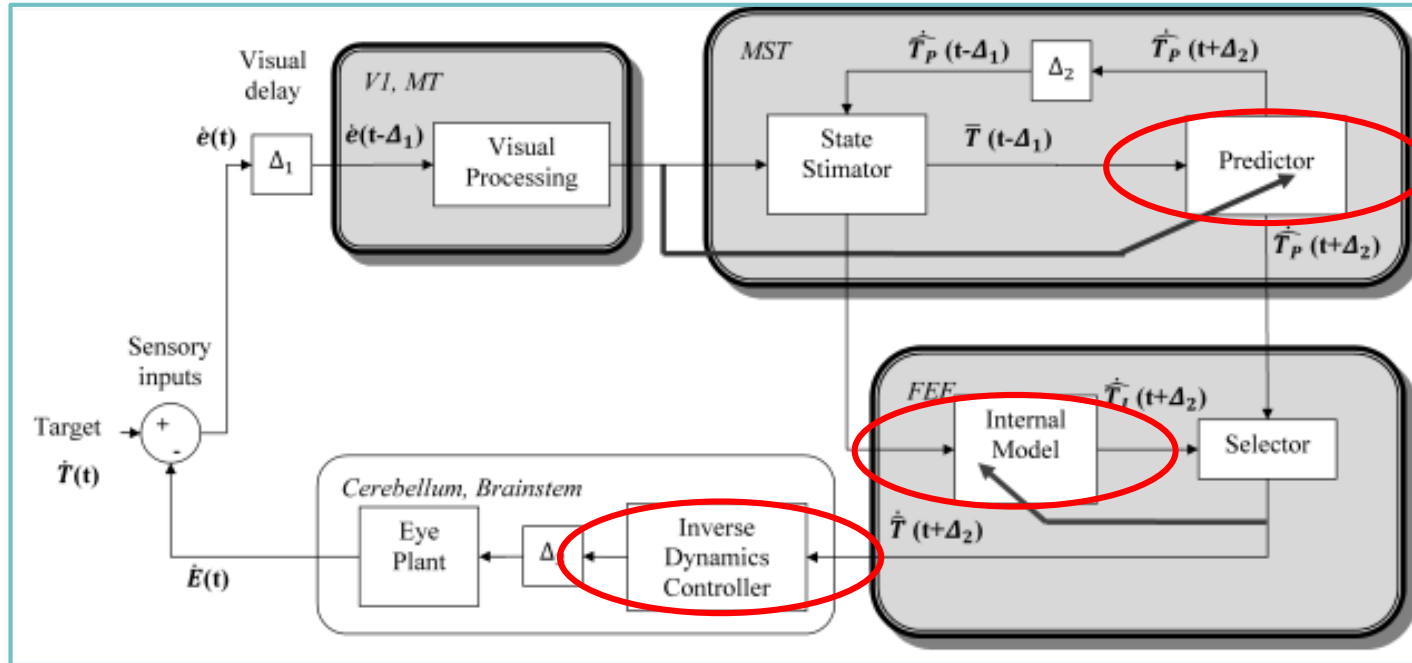

This circuit is based on Shibata and Schaal's model (Shibata 2005) of smooth pursuit and consists of **three subsystems**:

1. a **recurrent neural network** (RNN) mapped onto medial superior temporal area (MST), which receives the retinal slip with delays and **predicts** the current target motion,
2. an **inverse dynamics controller** (IDC) of the oculomotor system, mapped onto the cerebellum and the brainstem,
3. and a **memory block** that recognizes the target dynamics and provides the correct weights values before the RNN.



# Predictive smooth pursuit on a robot head



iCub platform head, 6 dof:  
3 for the eyes  
3 for the neck

The *retinal slip* (target velocity onto the retina) reaches zero after that the algorithm converges. When the target is unexpectedly stopped, the system goes on tracking the target for a short time.

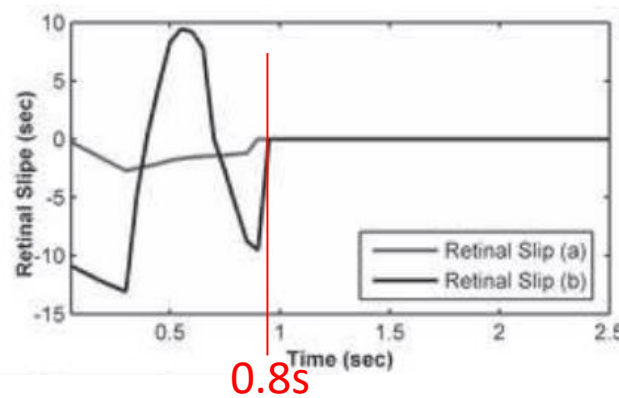
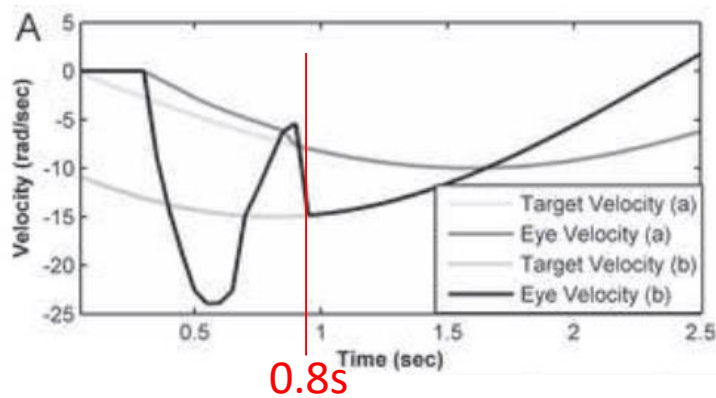

Sinusoidal dynamics:  
a) angular frequency:  
1 rad/s, amplitude:  
10 rad, phase:  $\pi/2$   
b) angular frequency:  
1 rad/s, amplitude:  
15 rad, phase of  $\frac{3}{4}\pi$

# Punching a moving target - robot experiments



The prediction is iterated ahead 0.5 seconds  
As the predicted target is inside the arm workspace, the robot executes a movement to punch the ball in the ***predicted position***



# Architectures for robot sensory-motor behaviour

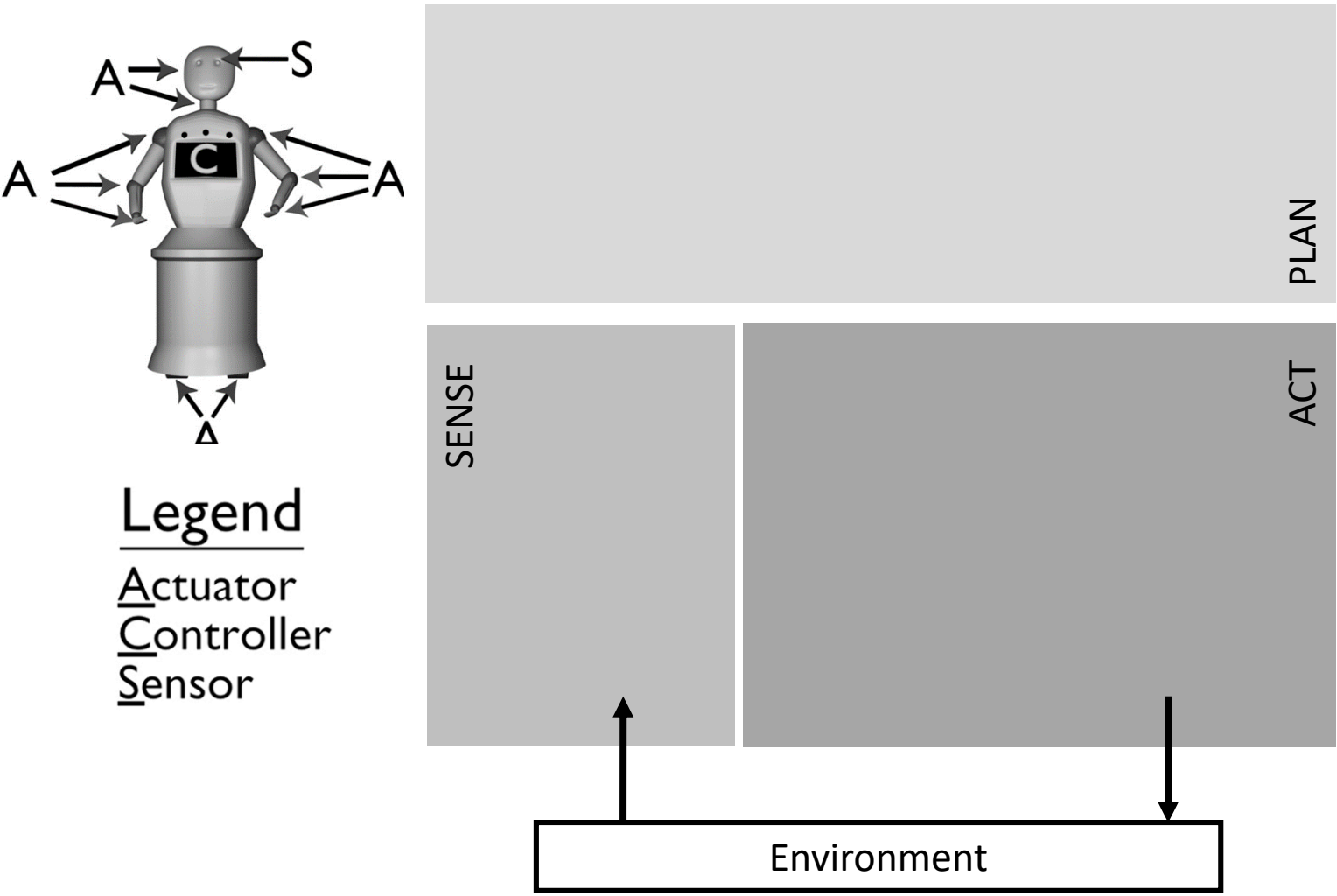

# Architectures for robot sensory-motor behaviour

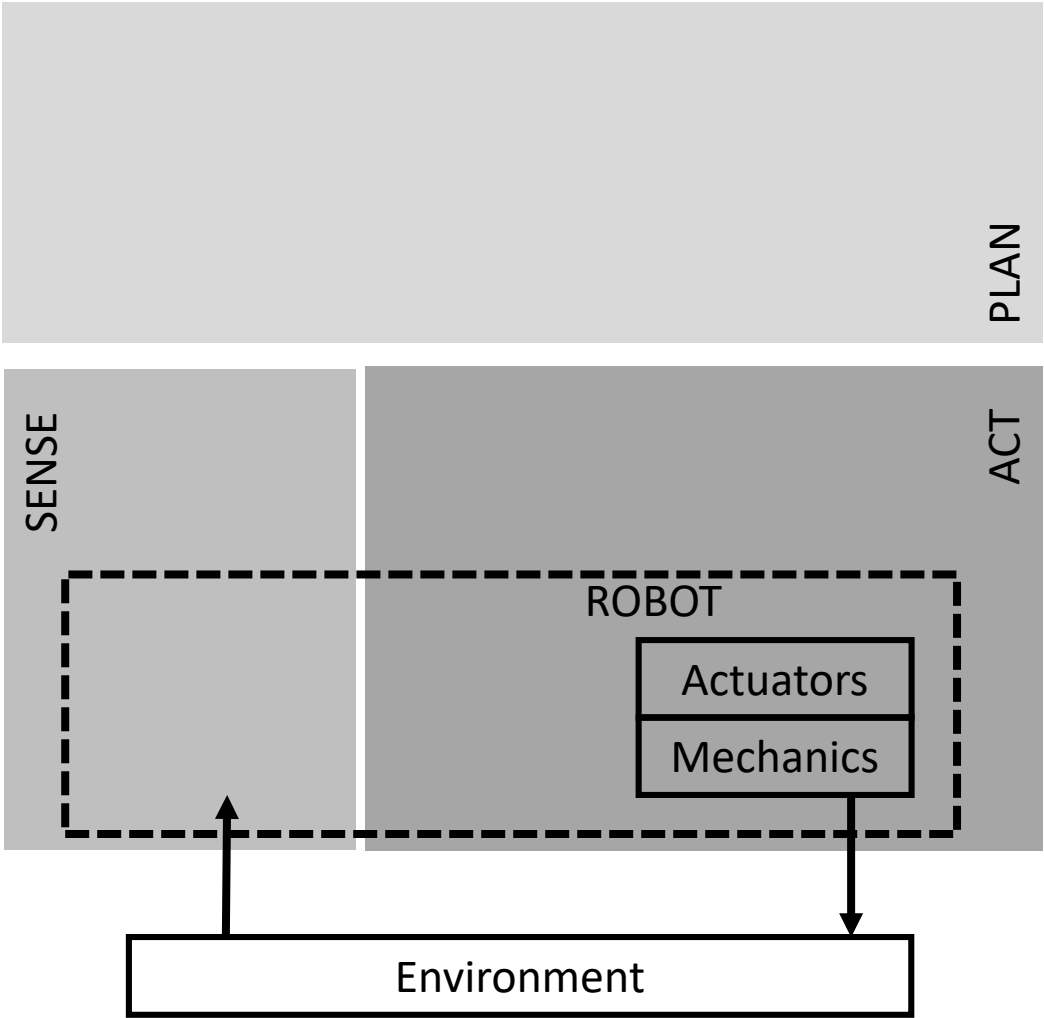

# Embodied Intelligence & Morphological Computation

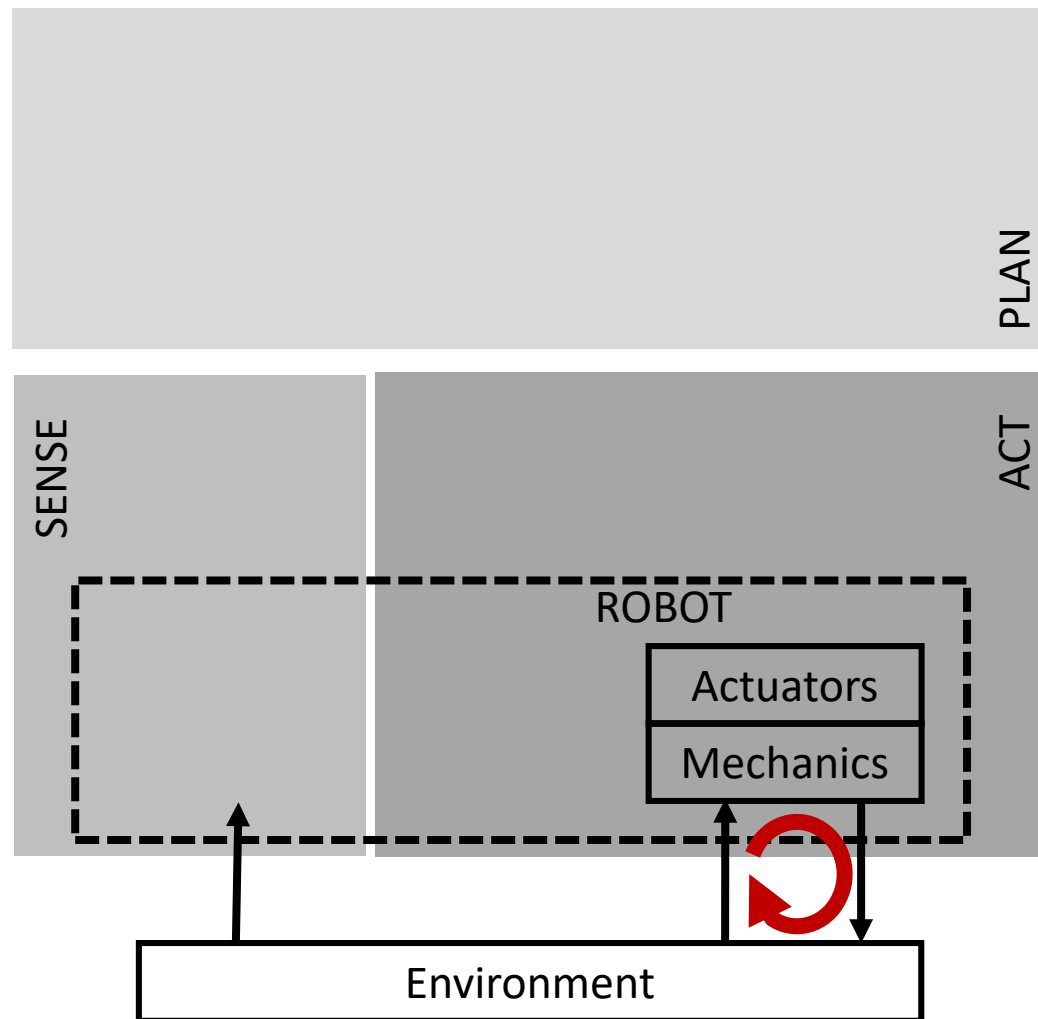



# Robot low-level control

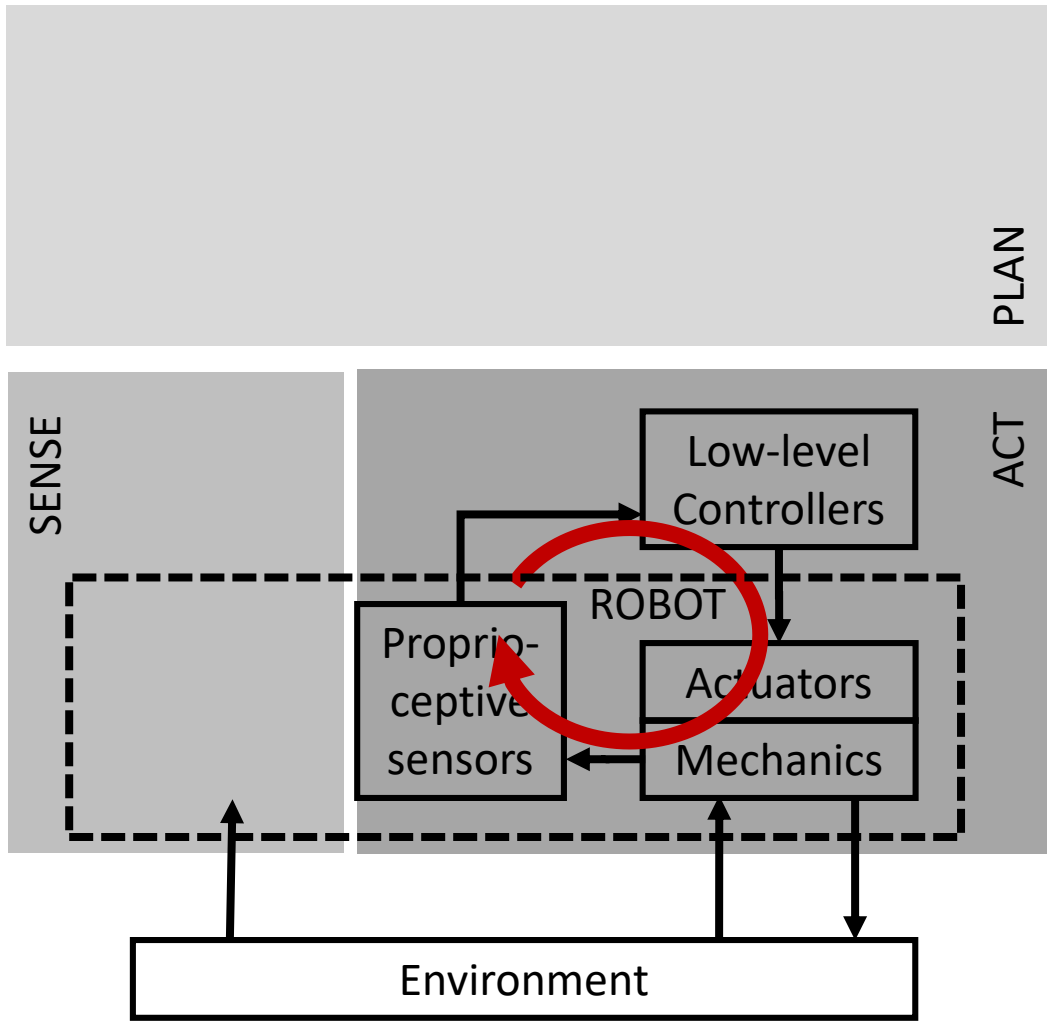

# Architectures for robot sensory-motor behaviour

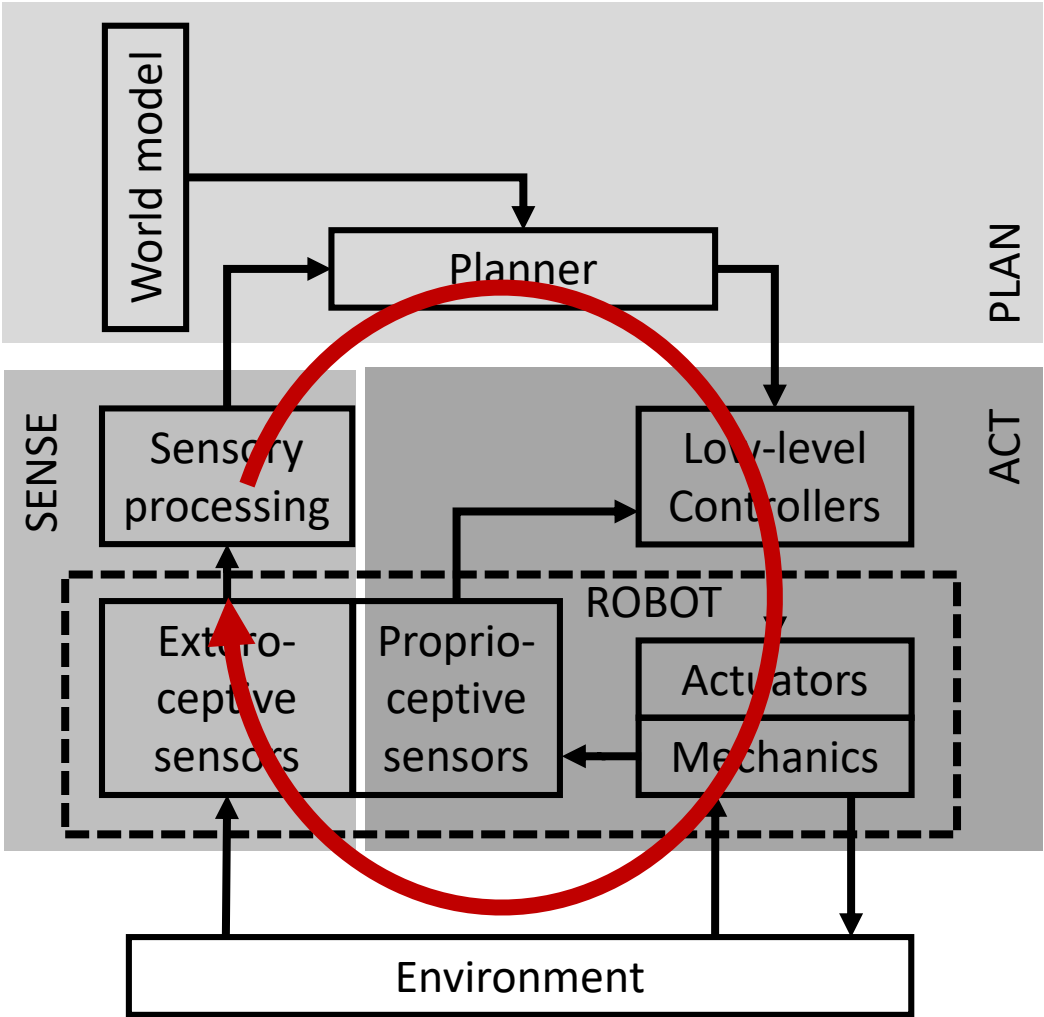

Hierarchical architectures



# Architectures for robot sensory-motor behaviour

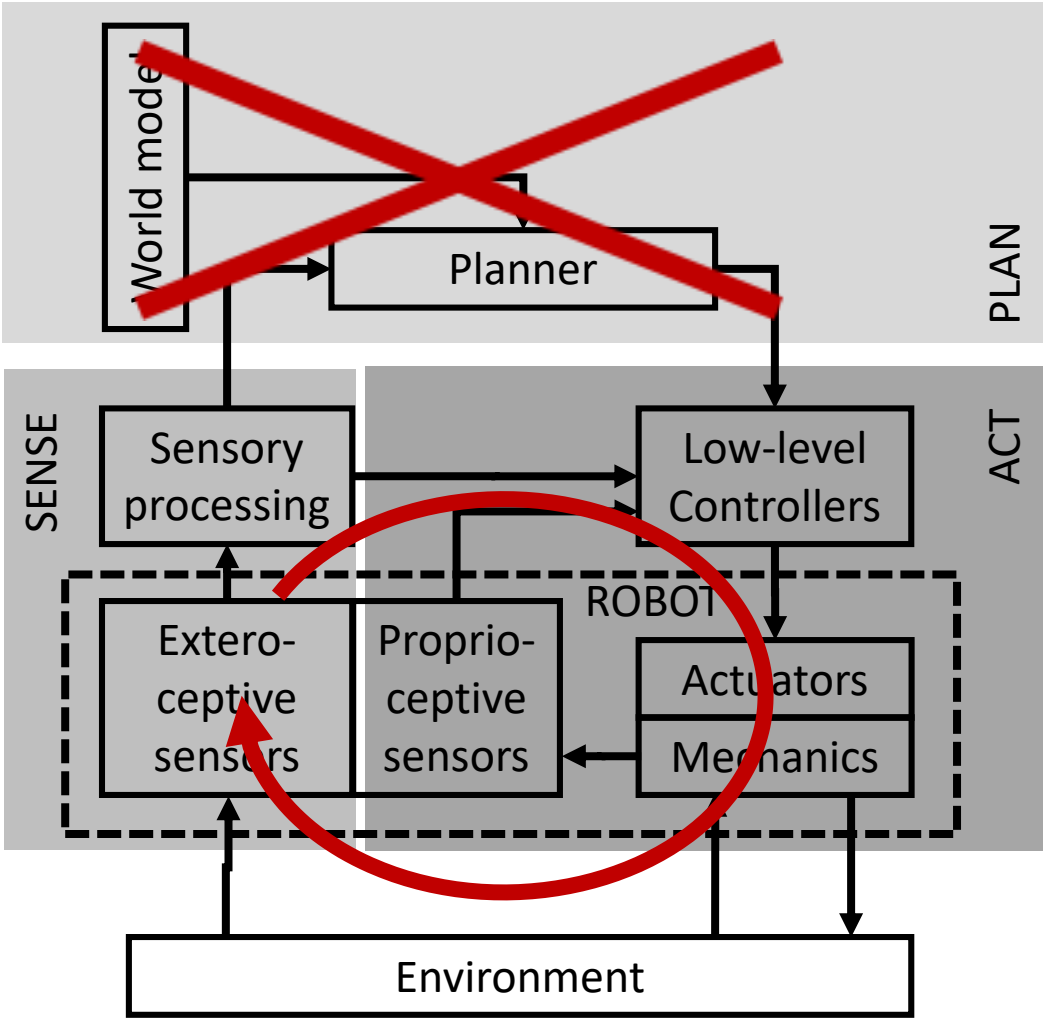

Reactive architectures



# Architectures for robot sensory-motor behaviour

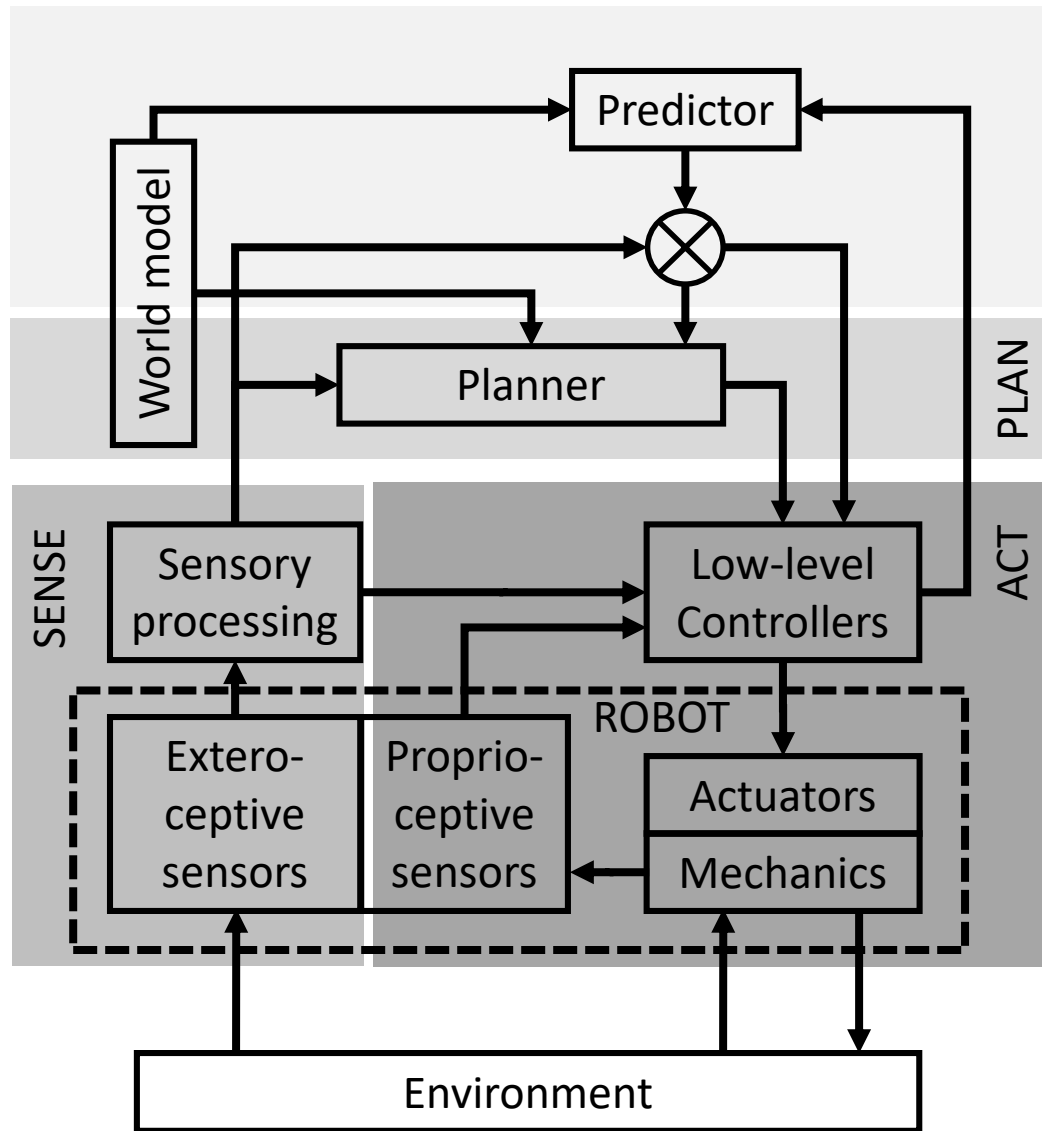

Predictive architectures

