

Master in Bionics Engineering

University of Pisa and Scuola Superiore Sant'Anna

Human and Animal Models for BioRobotics

THE BIROBOTICS
INSTITUTE



Scuola Superiore
Sant'Anna

Fundamentals of robot navigation

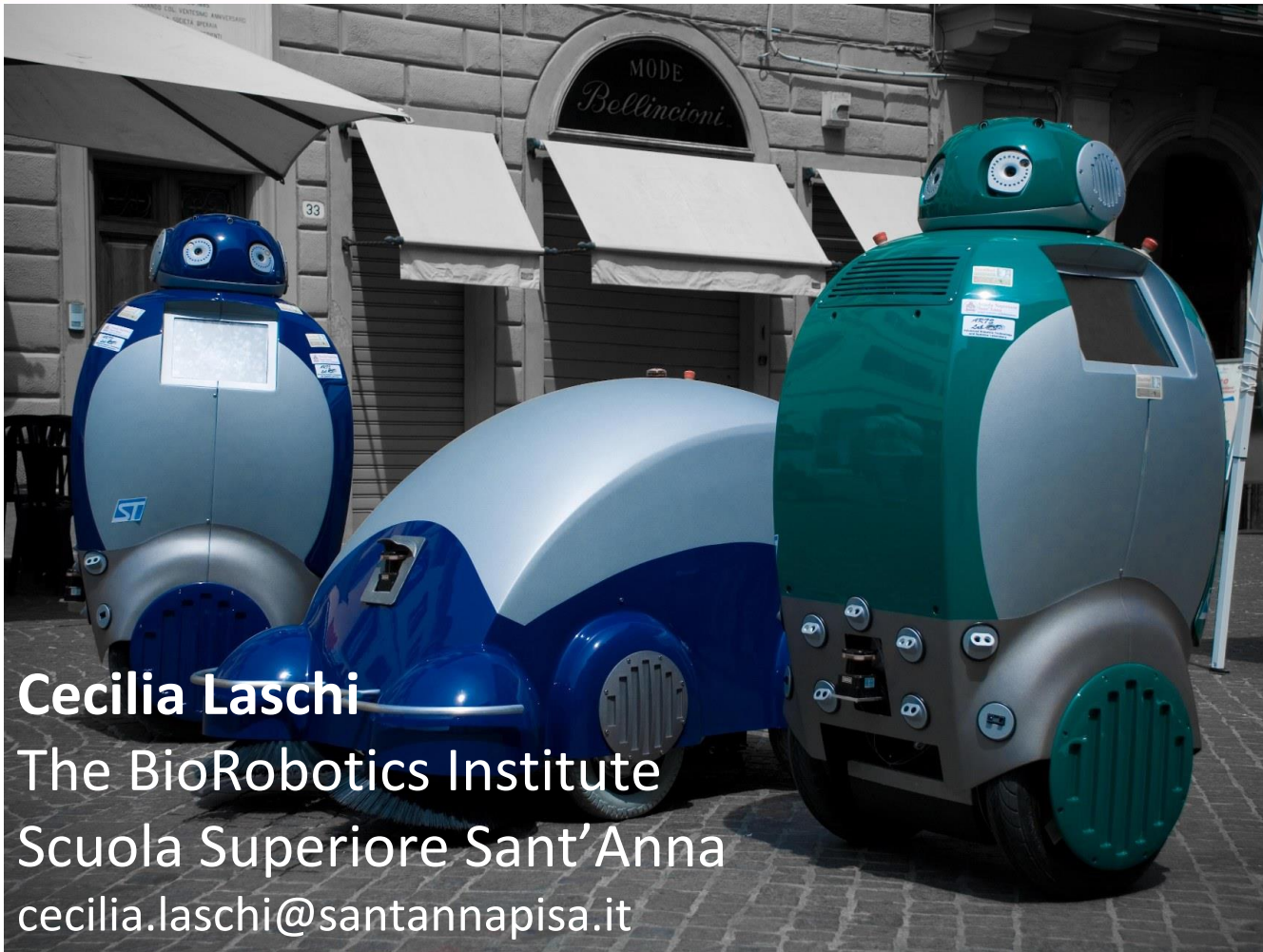

Cecilia Laschi

The BioRobotics Institute

Scuola Superiore Sant'Anna

cecilia.laschi@santannapisa.it





Robot definition

Scuola Superiore
Sant'Anna

A robot is an autonomous system which exists in the physical world, can sense its environment, and can act on it to achieve some goals





What's in a robot?

Robot components

Scuola Superiore
Sant'Anna

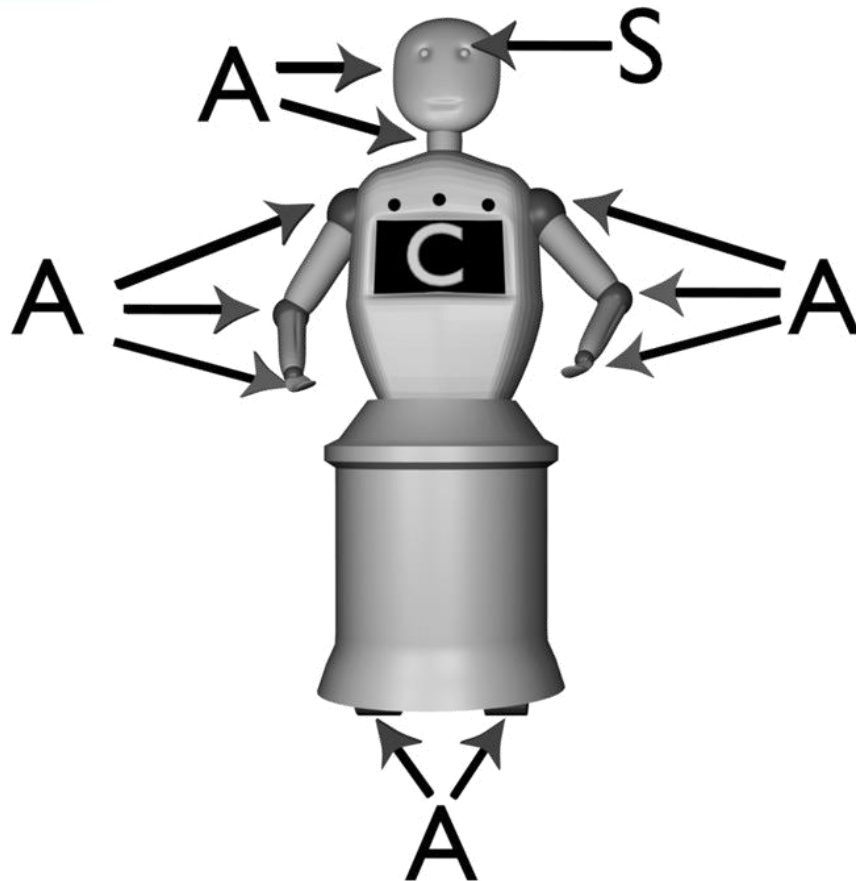

Legend

Actuator

Controller

Sensor

Effectors

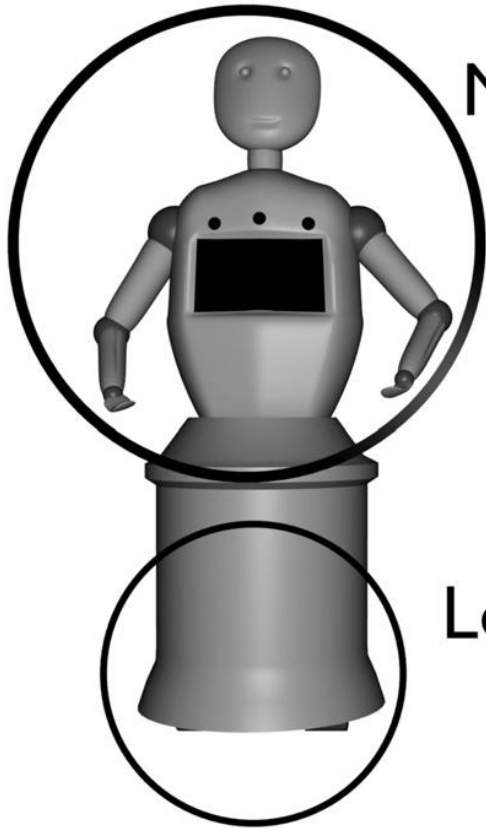

Manipulation

Locomotion

Robot arms

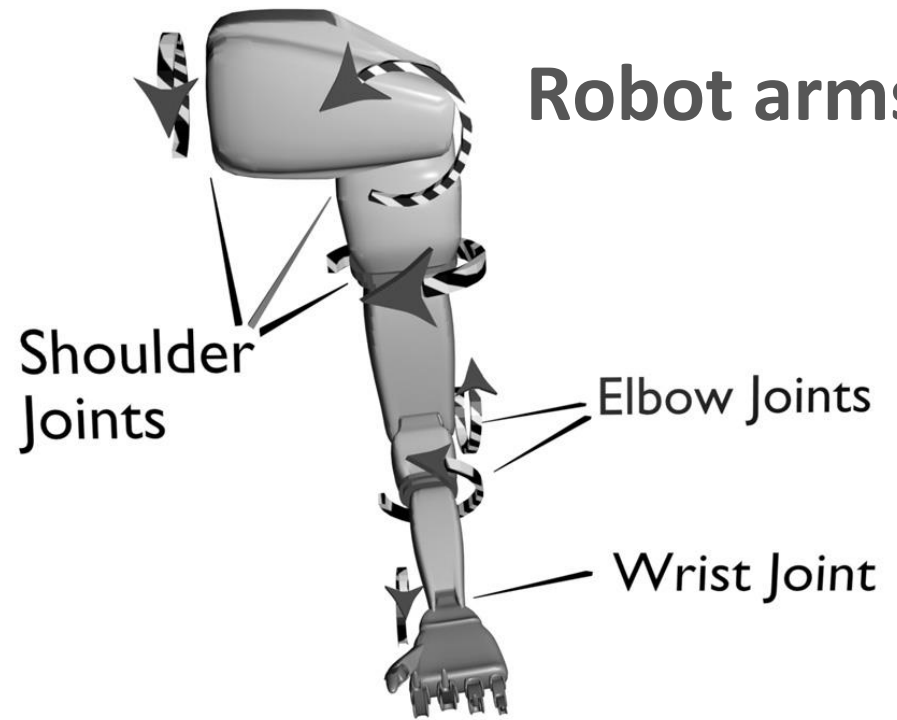

Shoulder Joints

Elbow Joints

Wrist Joint

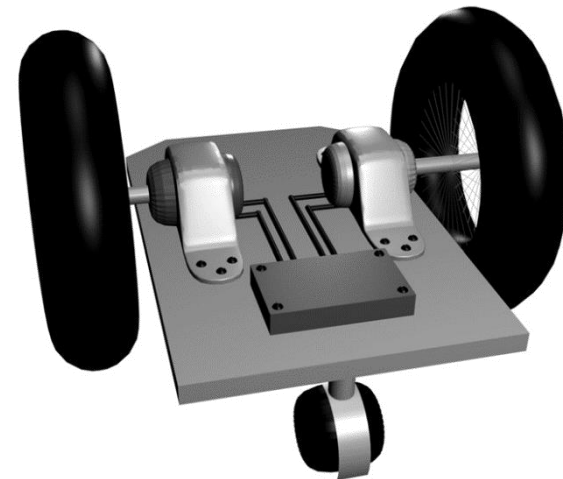

Mobile robots





Outline of the lecture

- Fundamental problems of robot navigation
- Maps and environment models
 - Metric maps and topological maps
- Planning techniques
 - Path Planning and Path Following
- Localization methods and systems
 - Odometry and systems based on active beacons and landmarks



Mobile robots and autonomous navigation



DustBot (DustCart & DustClean)



Autonomous cars





Position of a mobile robot

Scuola Superiore
Sant'Anna

Reference coordinate system fixed in the world

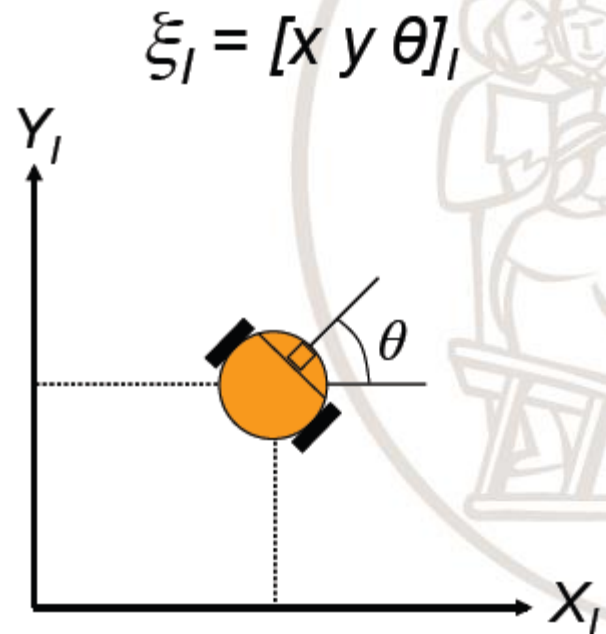
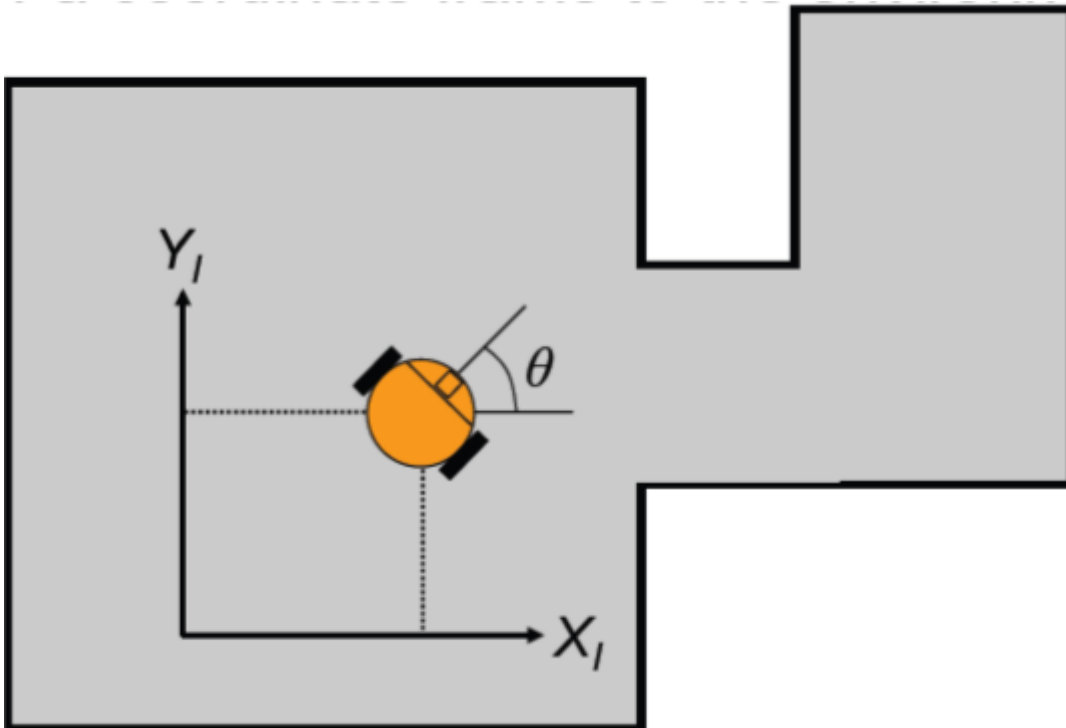

Position of a mobile robot

Scuola Superiore
Sant'Anna

Reference coordinate system fixed on the robot

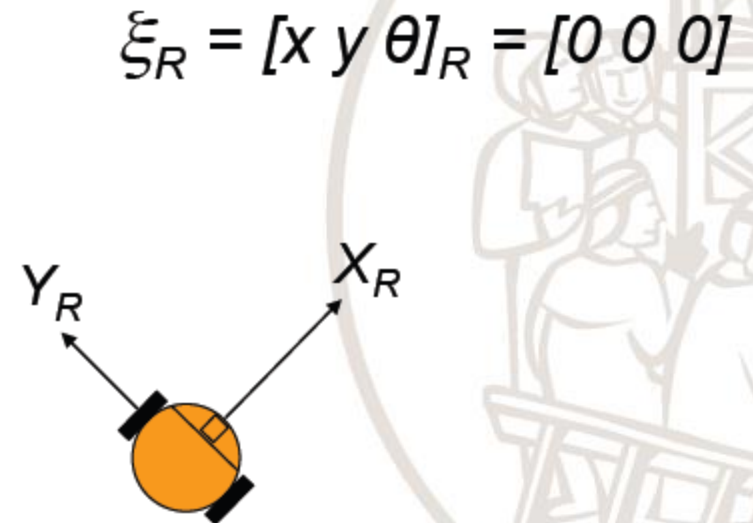
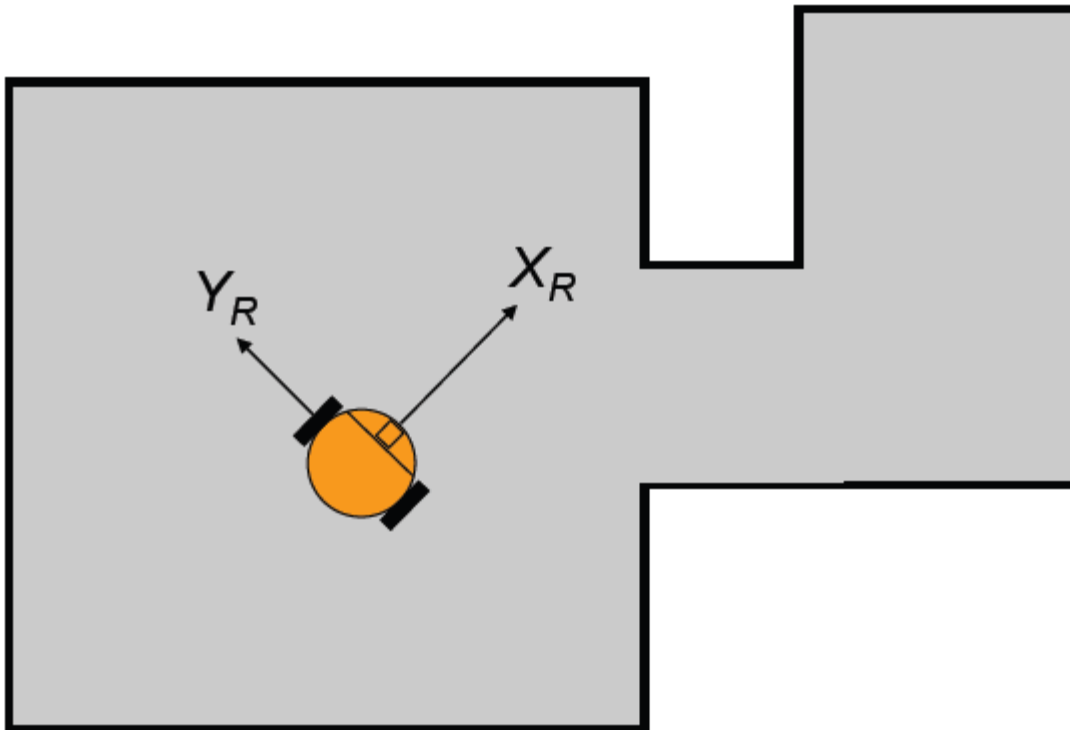



Position of an obstacle

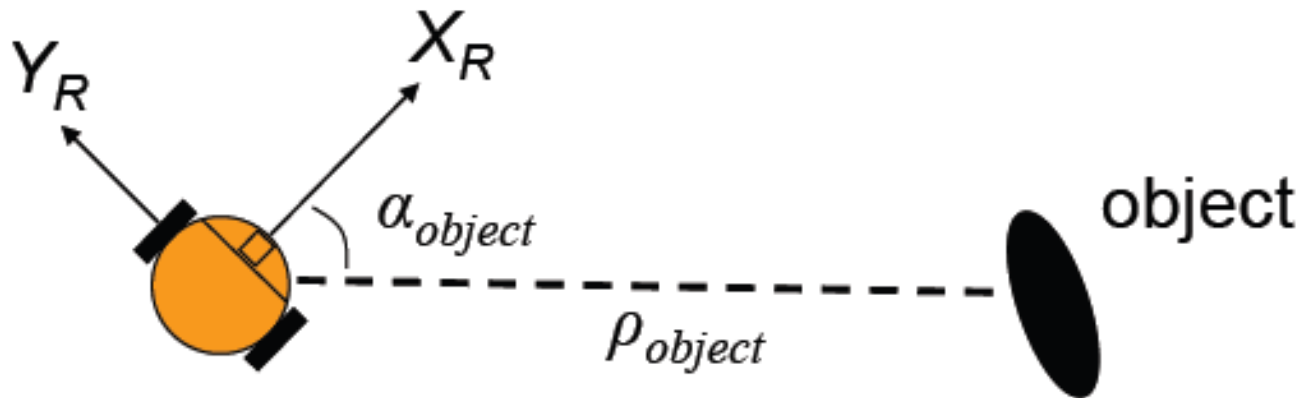

Transformations between the world reference frame and the robot reference frame, in velocity space

THE BIROBOTICS INSTITUTE



Scuola Superiore Sant'Anna

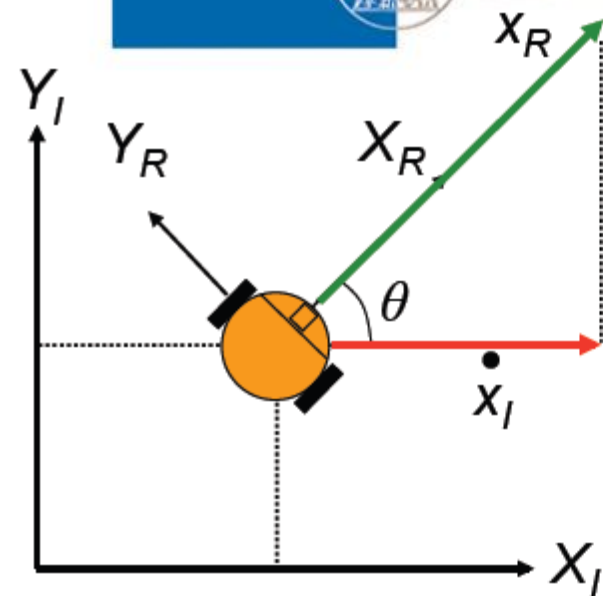

$$\dot{x}_I = \dot{x}_R \cos(\theta)$$

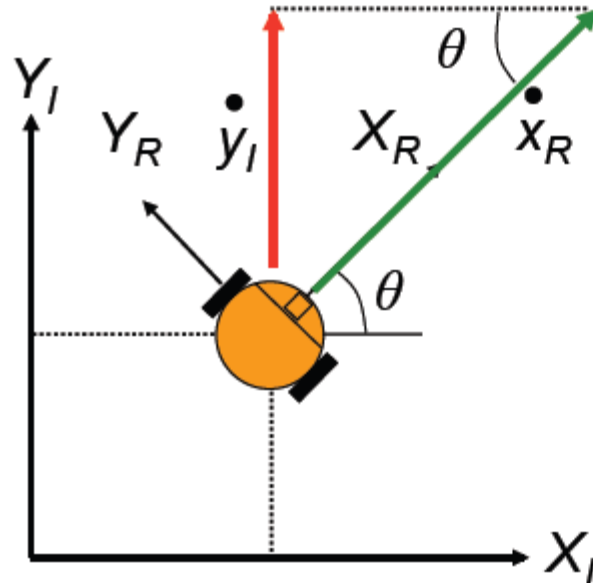

$$\dot{y}_I = \dot{x}_R \sin(\theta)$$

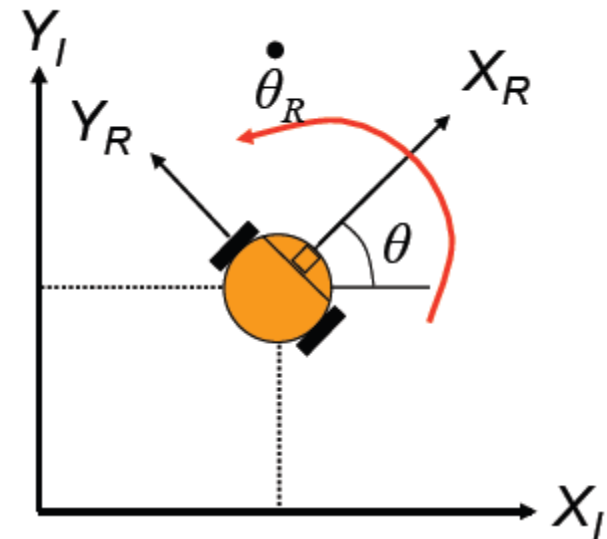

$$\dot{\theta}_I = \dot{\theta}_R$$

or

$$\begin{aligned} \dot{x}_r &= v \\ \dot{y}_r &= 0 \\ \dot{\theta}_r &= \omega \end{aligned}$$

$$\begin{pmatrix} \dot{x}_I \\ \dot{y}_I \\ \dot{\theta}_I \end{pmatrix} = \begin{pmatrix} \cos(\theta) & 0 & 0 \\ \sin(\theta) & 0 & 0 \\ 0 & 0 & 1 \end{pmatrix} \begin{pmatrix} \dot{x}_R \\ \dot{y}_R \\ \dot{\theta}_R \end{pmatrix}$$

$$\begin{pmatrix} \cos(\theta) & 0 \\ \sin(\theta) & 0 \\ 0 & 1 \end{pmatrix} \begin{pmatrix} v \\ w \end{pmatrix}$$



Outline of the lecture

Scuola Superiore
Sant'Anna

- **Fundamental problems of robot navigation**
- Maps and environment models
 - Metric maps and topological maps
- Planning techniques
 - Path Planning and Path Following
- Localization methods and systems
 - Odometry and systems based on active beacons and landmarks

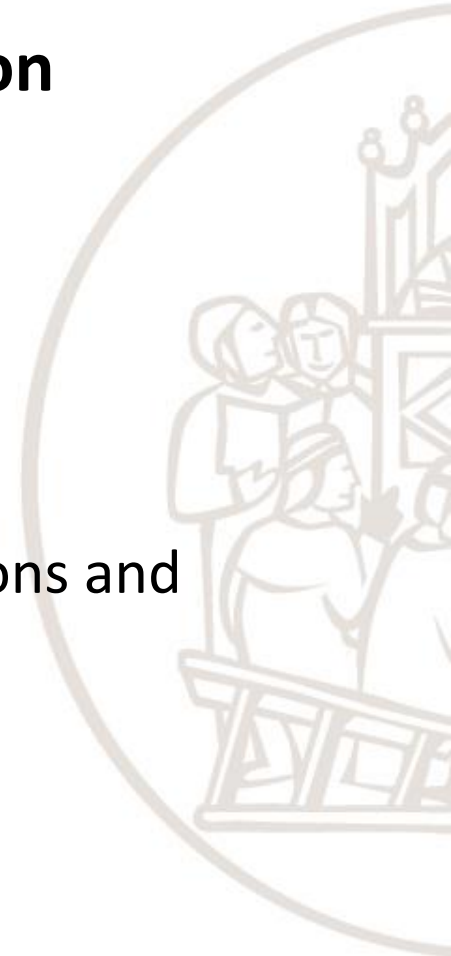



Robot navigation problem

To reach a final position from a starting position, given in geometric or sensory terms, avoiding obstacles

The classical questions to solve are:

- **Where am I?**
- **Where are the other objects around me?**
- **How can I reach a desired position?**





Classical approach

In the classical approach, the answers are:

- **Localization:** geometric position (x, y, θ coordinates in an absolute reference system) or sensory state in the robot environment
- **Maps or Models:** environment formalization and representation
- **Planning:** planning of robot movements in the environment

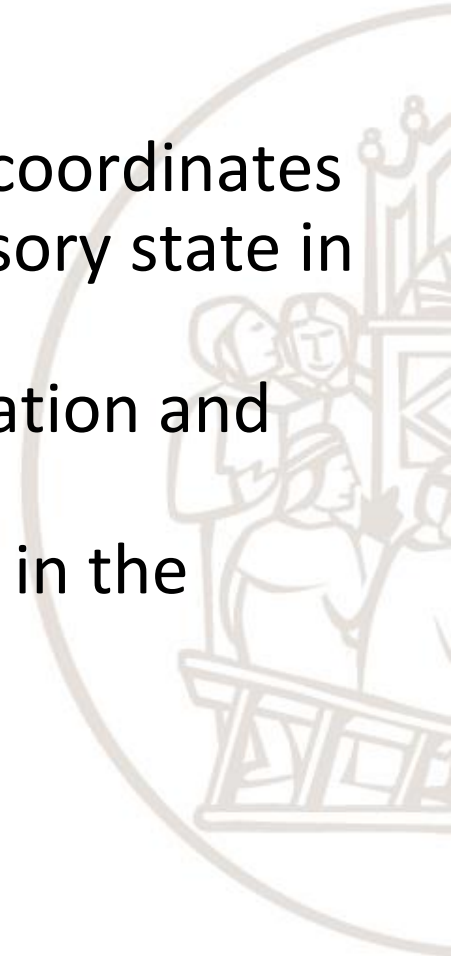



Reactive systems

- *In **reactive systems*** robots interact with the world through sensors and actuators.
- Knowledge is not modelled nor stored, but it is extracted 'on-line' from the world itself, through sensors.
- The robot behaviours are defined as reactions to the information perceived from the environment.
- Only the second and third questions are relevant and the answers are given in terms of actions.



Outline of the lecture

Scuola Superiore
Sant'Anna

- Fundamental problems of robot navigation
- **Maps and environment models**
 - **Metric maps and topological maps**
- Planning techniques
 - Path Planning and Path Following
- Localization methods and systems
 - Odometry and systems based on active beacons and landmarks



Maps and world representation

- **Metric Maps (Geometric):**

they represent the objects in the world on the basis of their size and coordinates in the absolute reference frame

- **Topological Maps:**

they represent the objects in the world (points of interest) on the basis of their characteristics and of the relations among them



Geometric maps

Main methods for world representation through metric maps:

- Occupancy grid
- Geometric description



Occupancy Grid

- The environment is represented on a bi-dimensional grid.
- A value is associated to each grid element, which indicates the cell state (free/occupied)

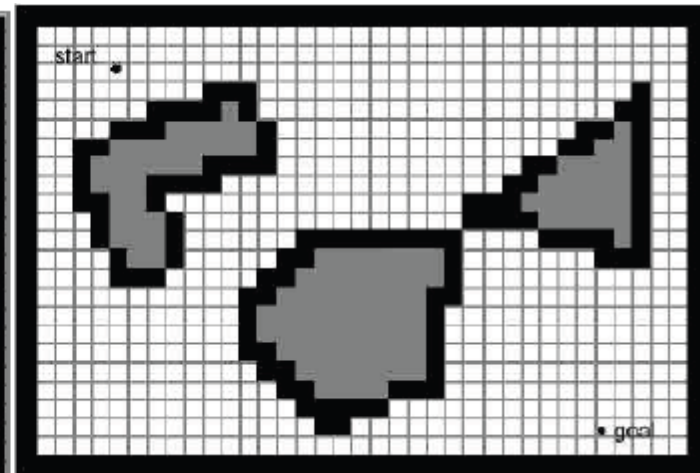
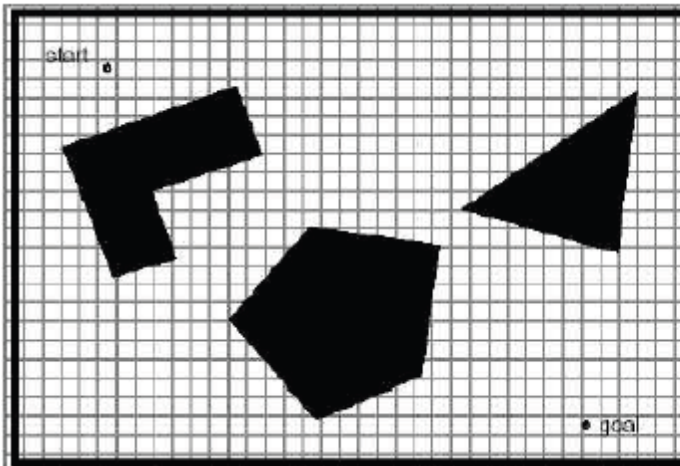

Occupancy Grid

- Fixed grid

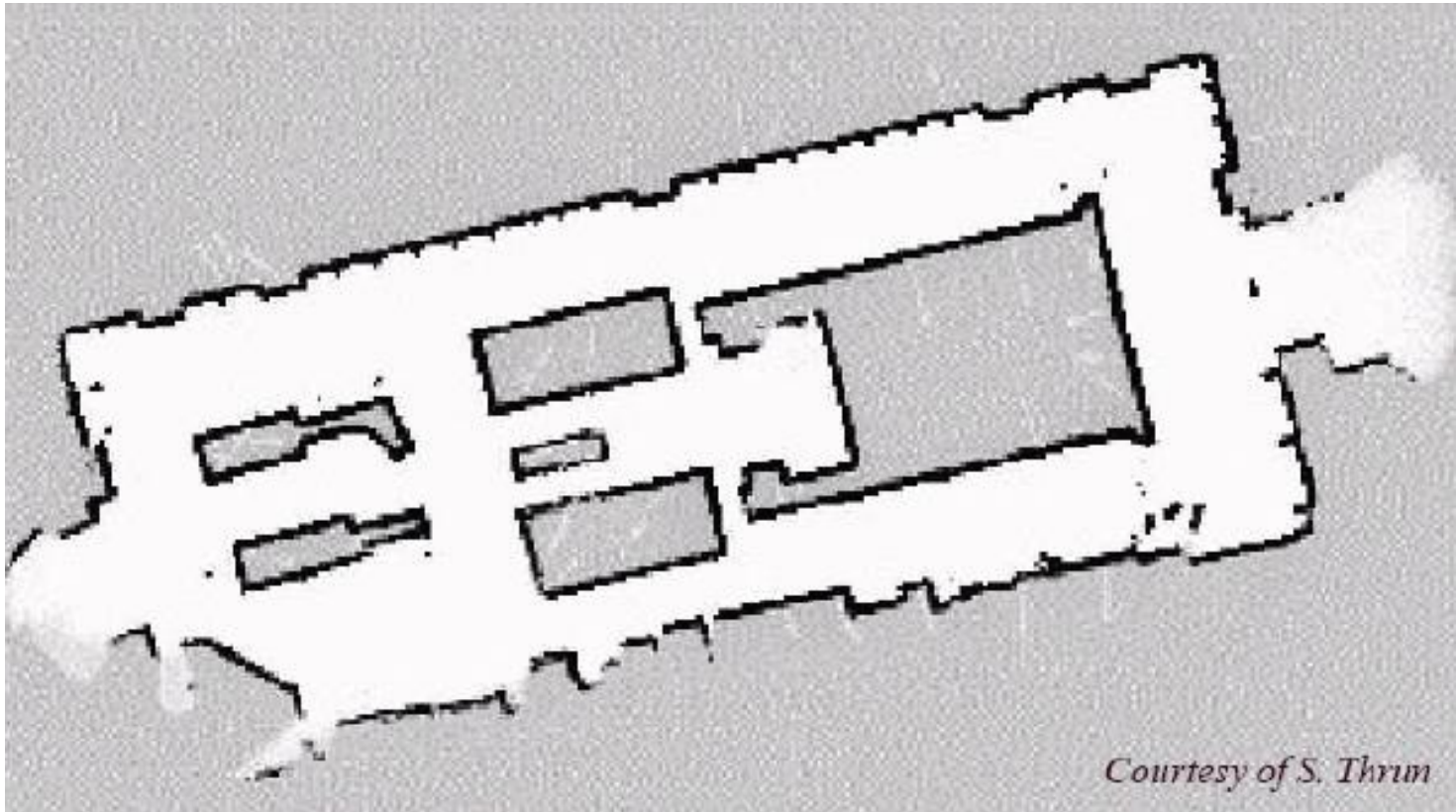

Occupancy Grid

- Variable grid

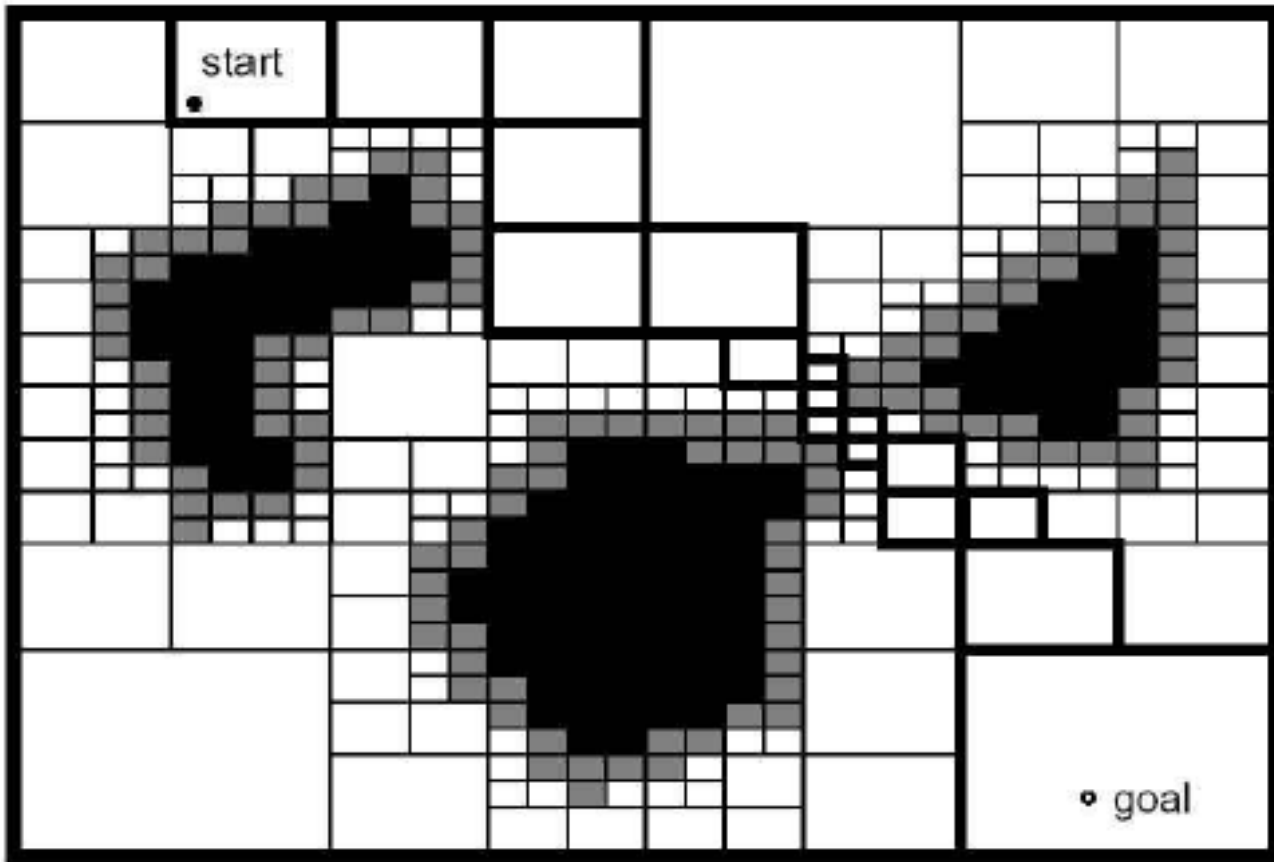

Geometric description

- The environment is represented through a geometric description, usually in terms of segments, obstacles and free space.

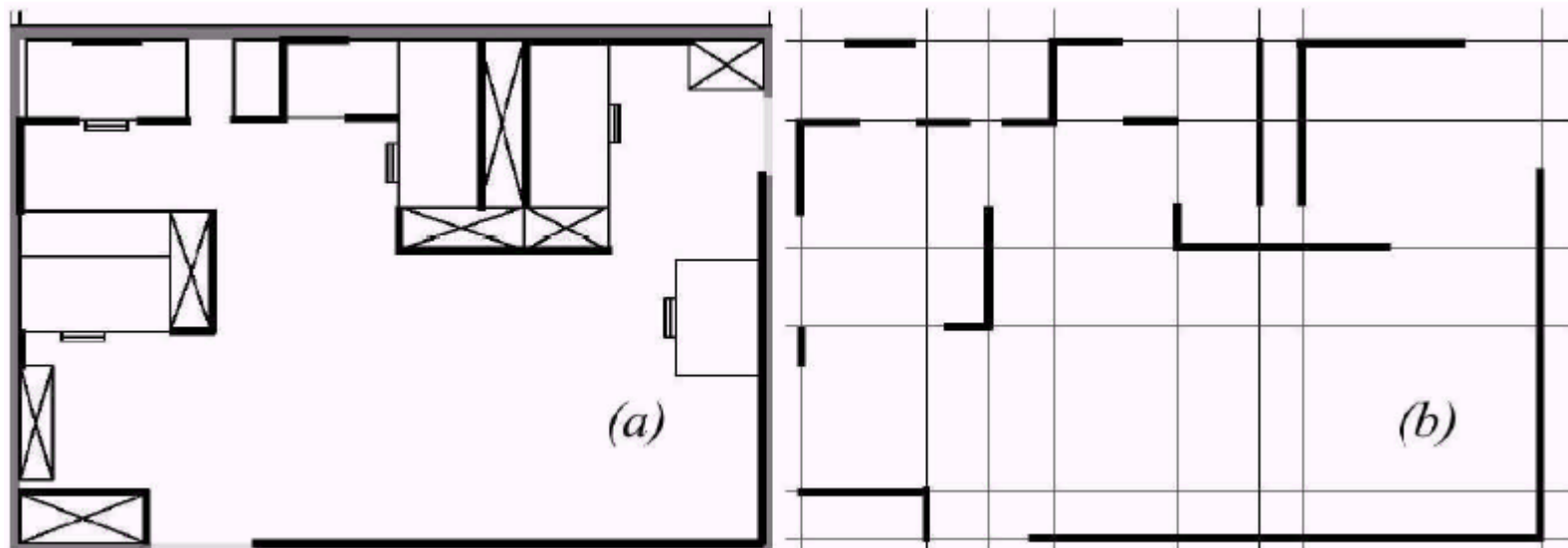

Topological maps

- The environment is defined in terms of points of interest, relevant for the robot, and of the relations among points of interest.
- A point of interest is an object (natural or artificial) which is relevant for robot navigation (e.g. walls, doors) or for robot tasks (e.g. tables, beds, appliances).
- A point of interest can be defined by a position in the robot space or by a sensory state.



Topological maps

Topological Decomposition

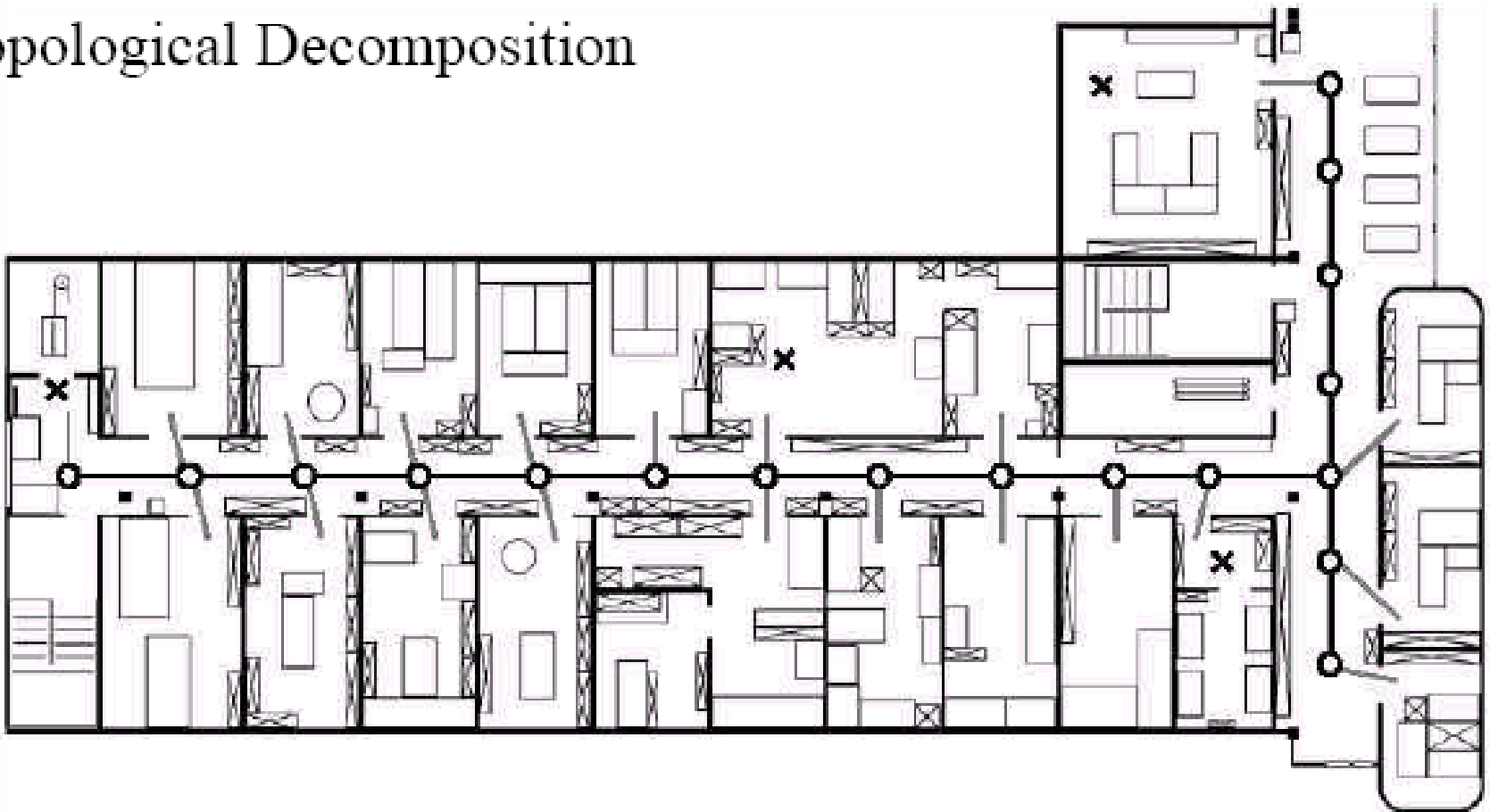

Topological maps

Example: map of a home environment with some points of interest

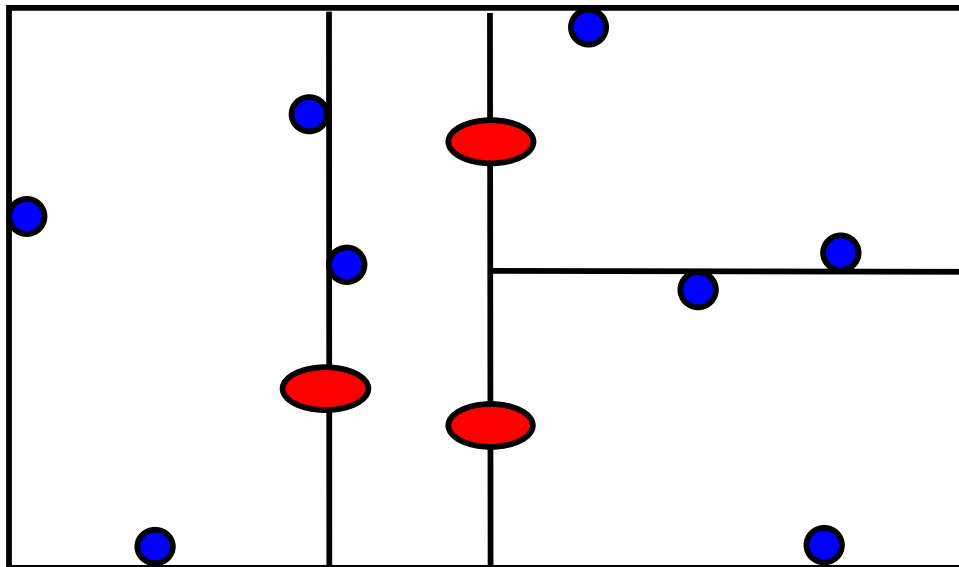

Door



Points of interest:

desk

bed

fridge

...



Representation of a topological map through a graph

- Assign a number to each room
- For each room, number the walls clockwise
- For each wall, number the points of interest clockwise

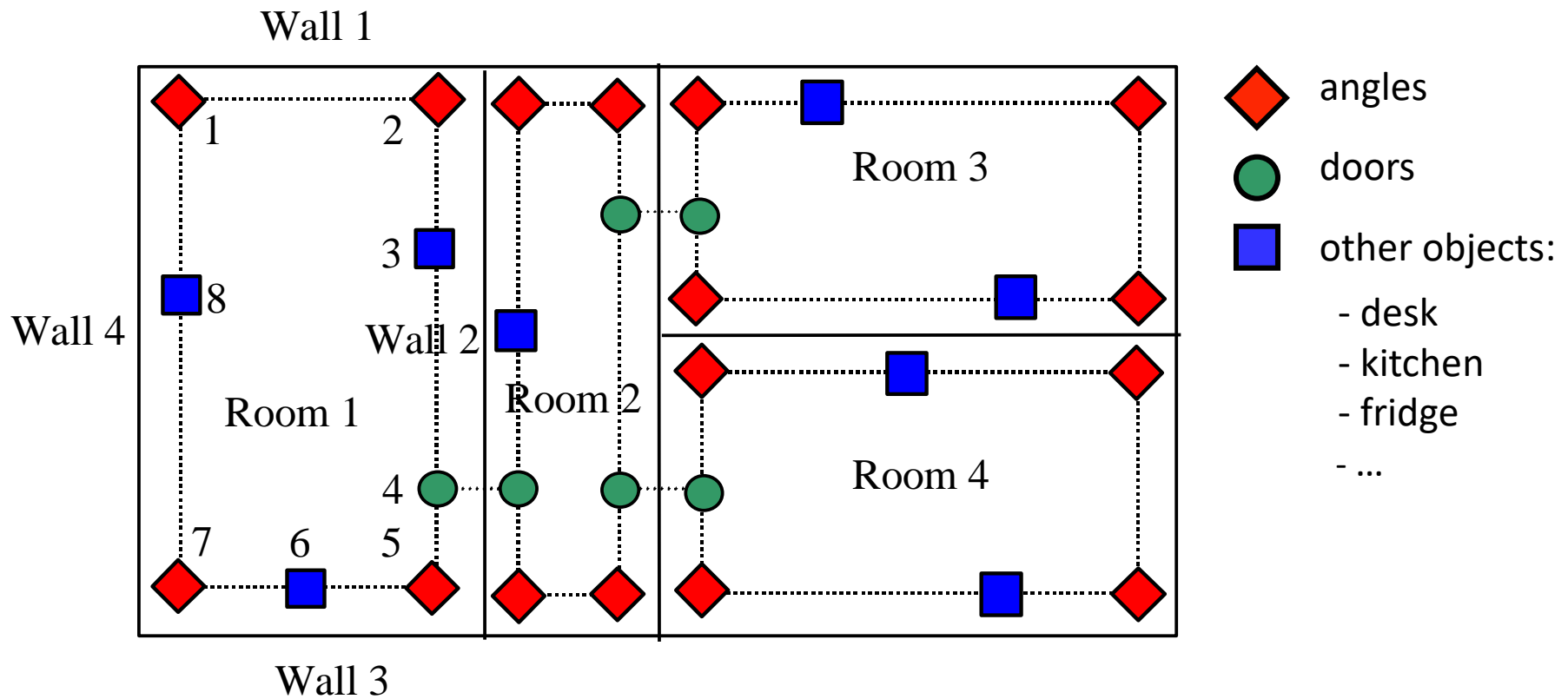

Representation of a topological map through a graph

$$G = (N, E)$$

$N = \{\text{points of interest}\}$

$E = \{(p, q) \mid (p \in N, q \in N, p = q \pm 1) \vee (p \text{ and } q \text{ represent the same door for two different rooms})\}$

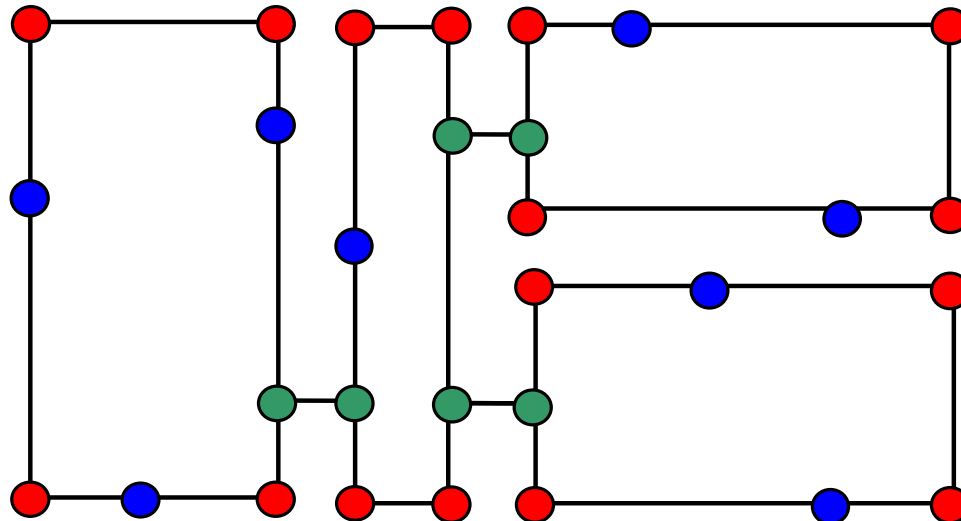



Outline of the lecture

Scuola Superiore
Sant'Anna

- Fundamental problems of robot navigation
- Maps and environment models
 - Metric maps and topological maps
- **Planning techniques**
 - **Path Planning and Path Following**
- Localization methods and systems
 - Odometry and systems based on active beacons and landmarks



Planning and world models

The objective of planning is to find a trajectory for the robot to reach a goal configuration, from a start configuration (its current position), avoiding obstacles

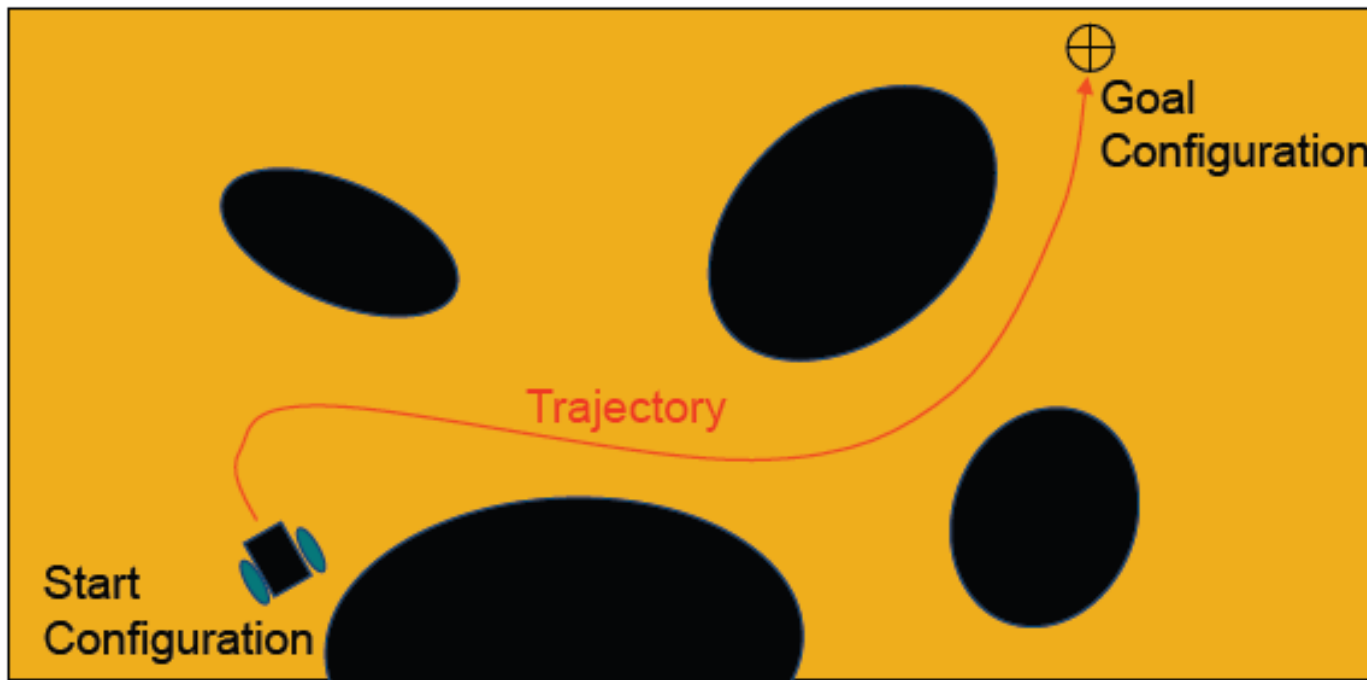

Planning and world models

- The robot size can be used to increase the obstacle size and then consider the robot as a point

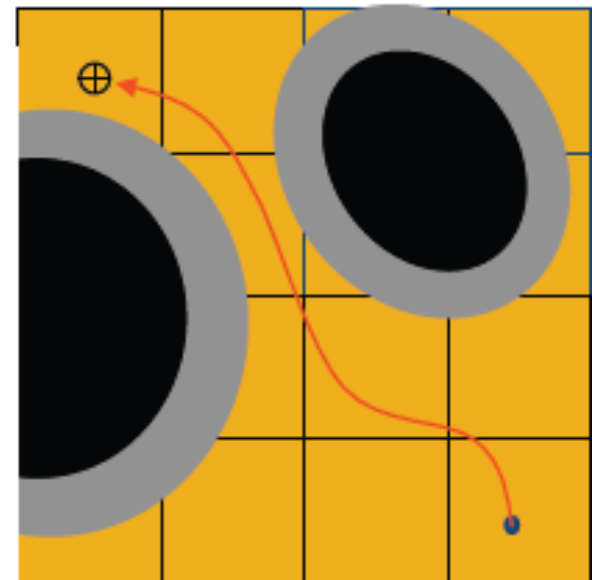
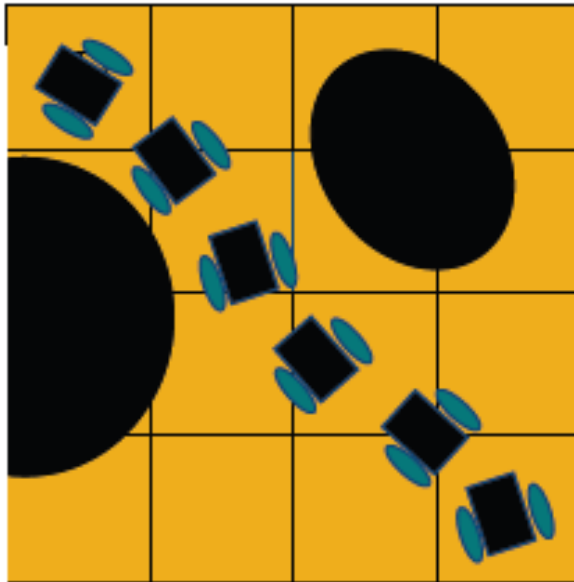

Planning and world models

Planning is divided in:

- **Path Planning:** techniques for finding trajectories for the robot to reach the goal configuration, avoiding obstacles
- **Path Following:** techniques for executing the trajectories generated by the Path Planning, avoiding unexpected obstacles.



Configuration Space

- Space is named Configuration Space or C_{space} (configurations that the robot can reach).
- The robot is represented in C_{space} as a point.
- Obstacles are represented in C_{space} .
- The region of obstacles is named C_{obstacle} .
- The region of free space is named C_{free} .
- A path is a trajectory between two configurations q_{init} and q_{goal} of C_{space} belonging to C_{free} .



Path Planning and world models for geometric maps

Main Path Planning techniques based on geometric maps:

- **Roadmaps**
- **Cell Decomposition**
- **Pontential Fields**



Roadmaps

- The Roadmap approach consists of connecting some points of the free space in a network, named Roadmap, made of unidimensional curves in the free space.
- The Path Planning problem becomes connecting the start and the goal configurations by finding a path in the roadmap.



Roadmap

Main Path Planning techniques based on the Roadmap approach:

- **Visibility Graph**
- **Voronoi Diagram**



Visibility Graph

- The visibility graph is a graph G whose nodes are the initial and goal configurations, q_{init} and q_{goal} , and all vertexes of the polygons which represent the obstacles in the map
- The edges of G are all the segments that connect two nodes in G and that do not intersect the obstacle polygons
- A weight can be associated to the edges, corresponding to the distance between the nodes that they connect
- A path from q_{init} and q_{goal} can be found on the graph G by using an algorithm for minimum paths which minimizes the distance

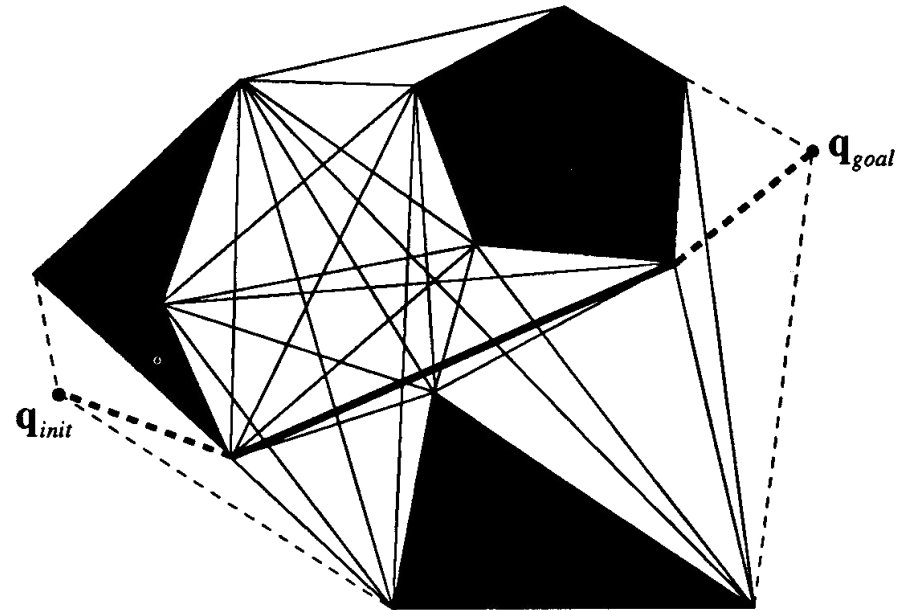

Visibility Graph

Example: visibility graph and the path found to navigate from q_{init} to q_{goal}

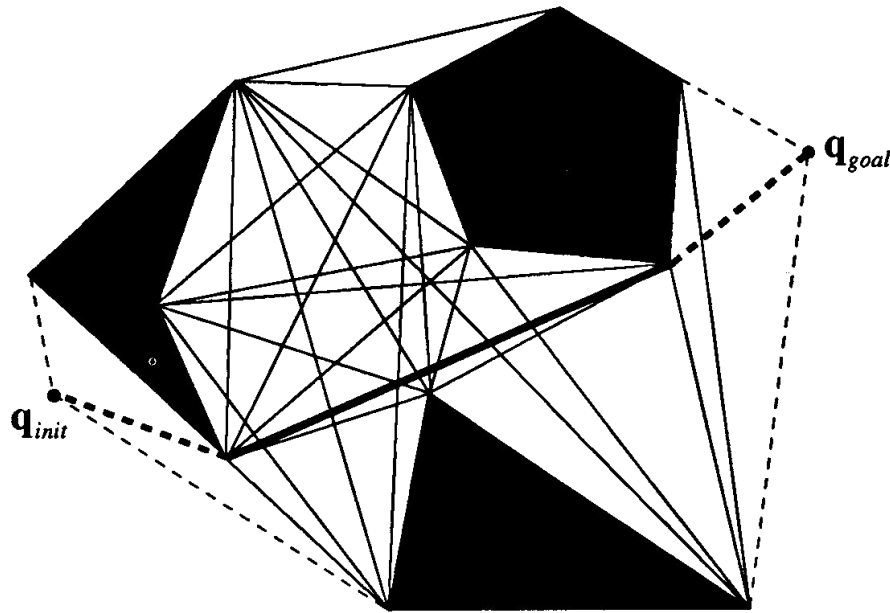

Voronoi Diagram

- It consists of defining all the free configurations in the free space, equidistant from the obstacle region
- If the obstacles are polygons, the Voronoi diagram consists of a finite set of segments and parabolic curves (roadmap).

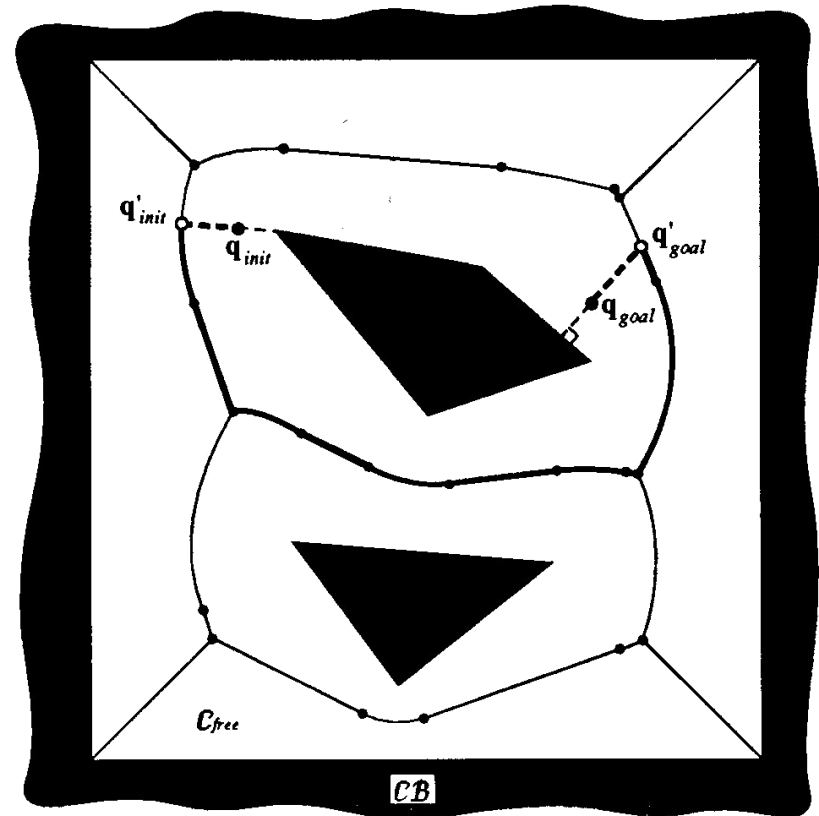

Voronoi Diagram

Given two configurations q_{init} and q_{goal} , a path is given by:

- Connecting q_{init} and q_{goal} to the roadmap in q'_{init} and q'_{goal} .
- Finding a path on the Voronoi diagram which connects q'_{init} and q'_{goal} .

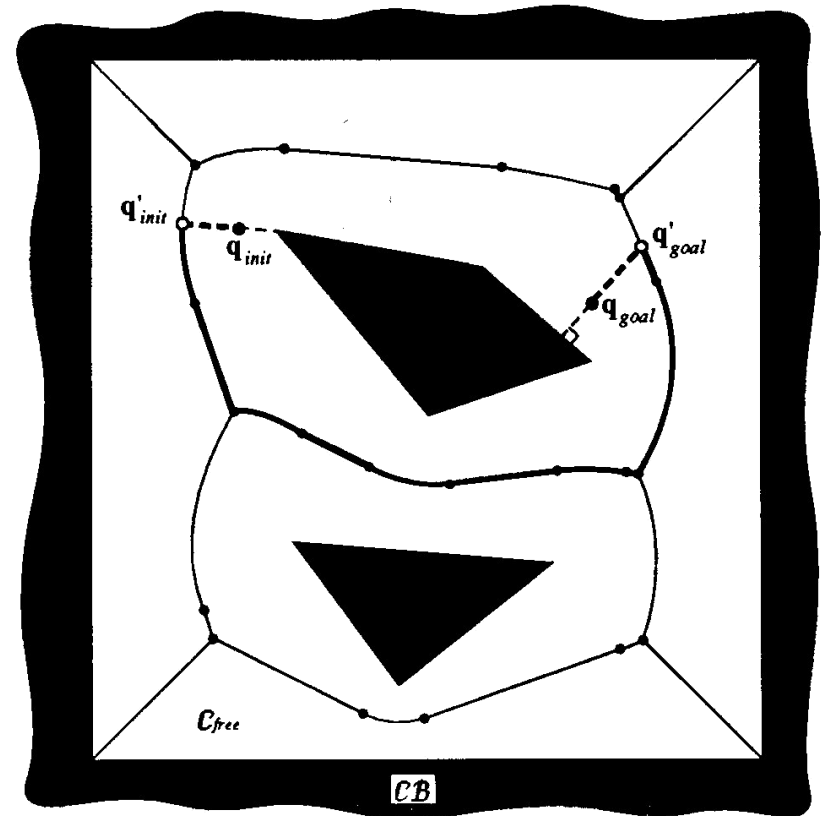

Voronoi Diagram

Example: Voronoi diagram and the path found to navigate from q_{init} to q_{goal}

The advantage of this technique is that the trajectories tend to maximise the distance of the robot from obstacles.

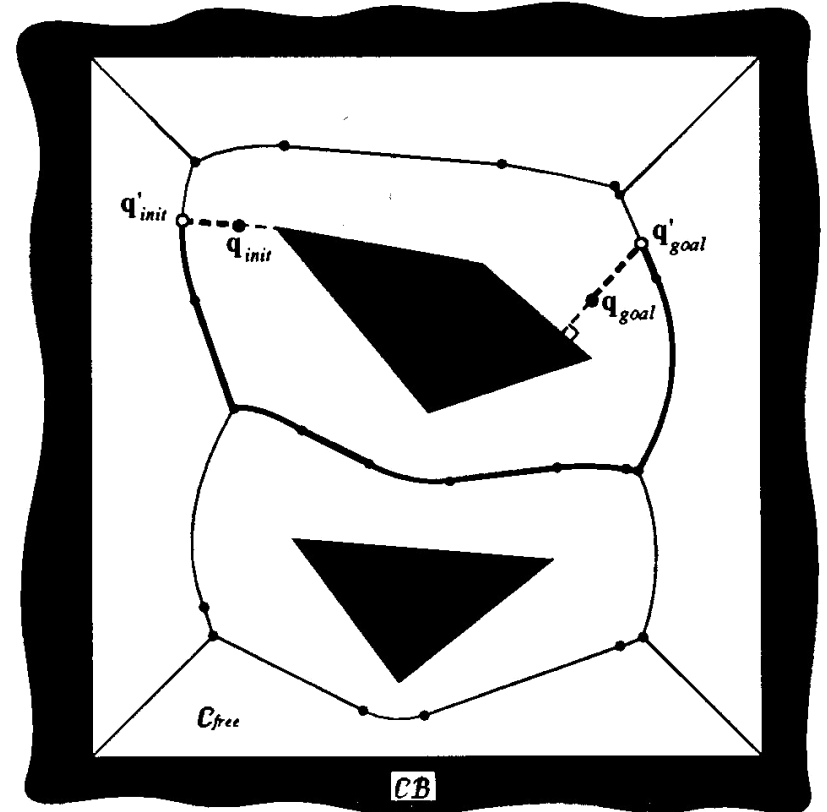

Cell Decomposition

- It consists of decomposing the free space in regions, named cells, such that a path between two adjacent cells can be easily found.
- The map is represented by a graph named **connectivity graph**.
- The graph nodes are the cells in the free space.
- Two nodes in the graph are connected if and only if the two cells that they represent are adjacent.



Cell Decomposition

Example of map and its cell decomposition

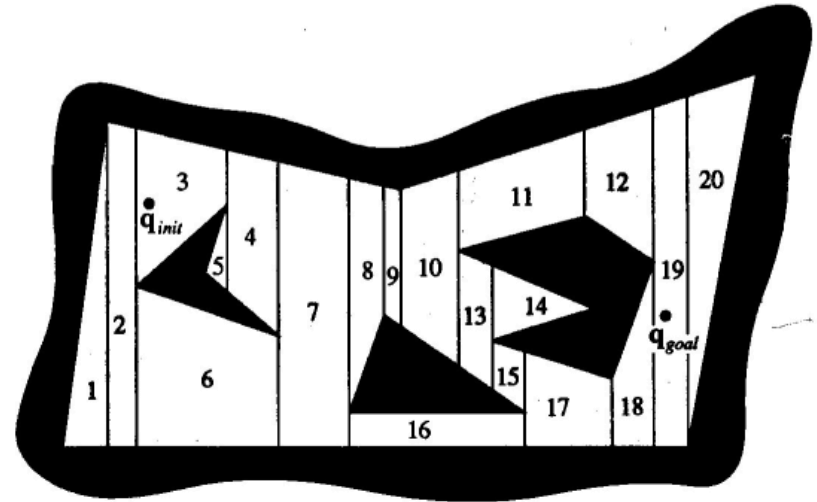
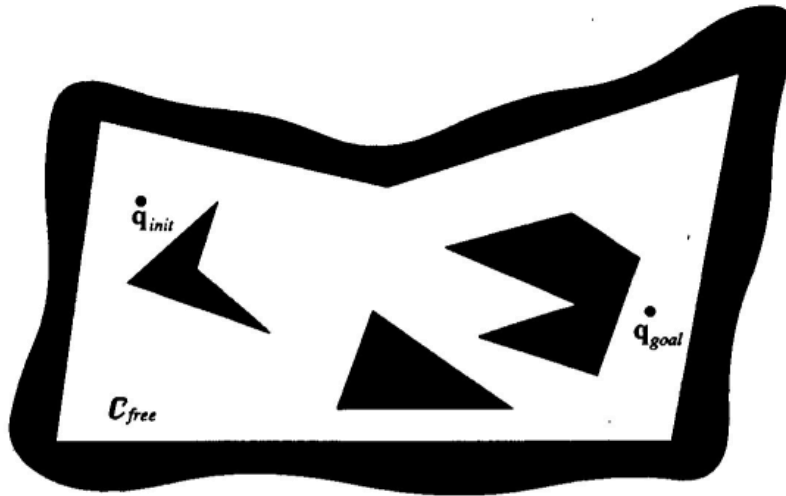

Connectivity graph associated to the map and the path found (in bold)

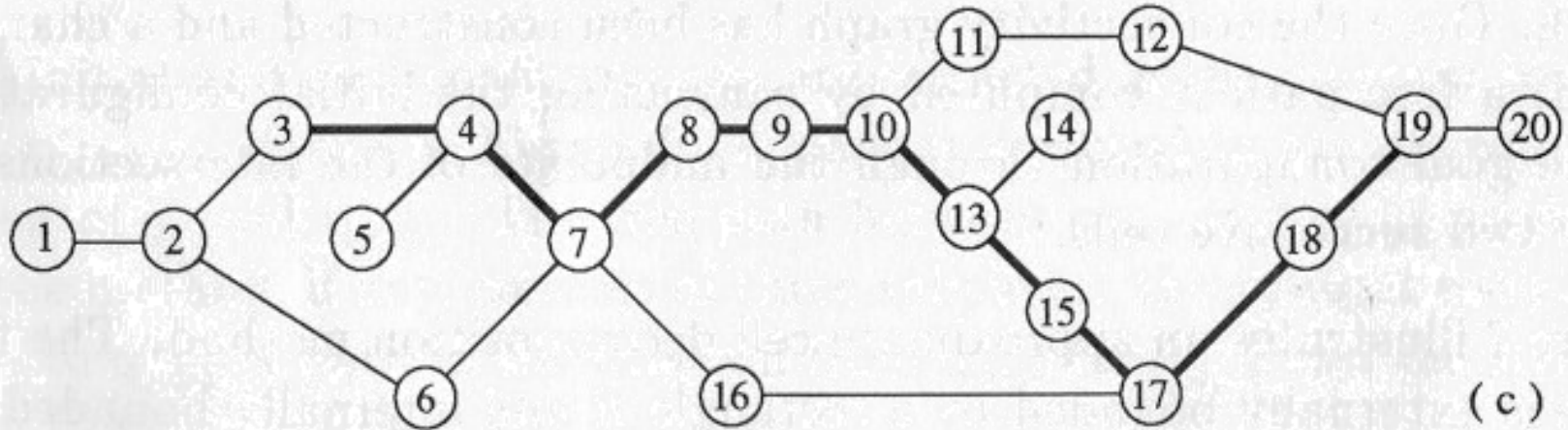

Cell Decomposition

- A trajectory for the robot is found by searching a path on the graph that connects the nodes containing q_{init} and q_{goal} .
- The result of the graph search is a sequence of cells named **canal**.
- The path is found by connecting the mid points of the canal cell boundaries.



Potential fields

- The robot is a point in space that moves under the influence of an **artificial potential** produced by the goal configuration and by the obstacles
- The final configuration generates an **attractive potential** which pulls the robot towards the goal
- The obstacles generate a **repulsive potential** which pushes the robot away from them
- The sum of attractive and repulsive potentials generates a force which moves the robot towards the goal, while avoiding obstacles



Potential fields

Example of attractive and repulsive potential

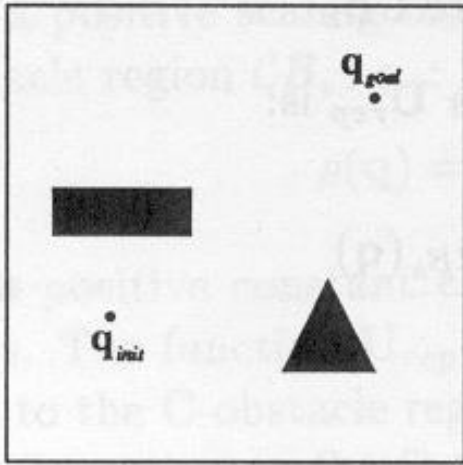

World map

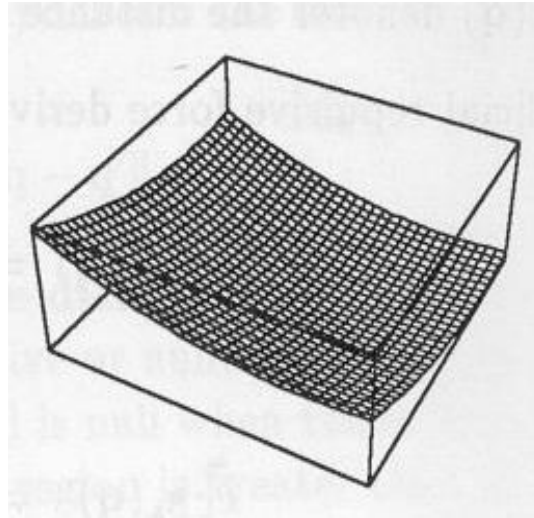

Hyperbolic attractive potential function

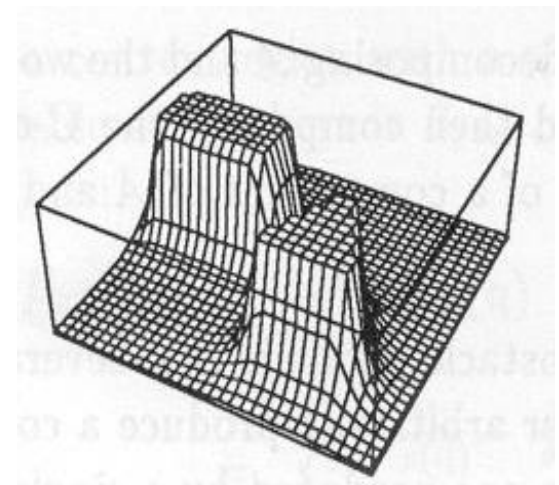

Repulsive potential function



Potential fields

- Differentiable potential function U with a local minimum in the point q_{goal}

$$U(q) = U(q)_{\text{att}} + U(q)_{\text{rep}}$$

$U(q)_{\text{att}}$ Attractive potential function

$U(q)_{\text{rep}}$ Repulsive potential function

- For each point q in space, the motion direction is given by the force function F

$$F(q) = -\nabla U(q) = -(F_{\text{att}}(q) + F_{\text{rep}}(q))$$

$$\nabla U(q) = (\delta U / \delta x, \delta U / \delta y)$$



Potential fields

Criteria for choosing the **attractive potential**

- Function with a local minimum in the point q_{goal}

$$U_{\text{att}}(q) = \frac{1}{2} \xi \rho_{\text{goal}}^2(q) \quad \text{parabolic potential}$$

where

$$\rho_{\text{goal}}(q) = \|q - q_{\text{goal}}\| \quad \text{Euclidean distance}$$

so that

$$F_{\text{att}}(q) = -\xi (q - q_{\text{goal}})$$



Potential fields

Criteria for choosing the **repulsive potential**

- Creating a protective barrier around the obstacle region, to avoid robot contact with the obstacles
- The repulsive force should not affect the robot motion when it is far from obstacles

$$U_{\text{rep}}(q) = \begin{cases} \frac{1}{2}\eta \left(\frac{1}{\rho(q)} - \frac{1}{\rho(q_0)} \right)^2 & \text{se } \rho(q) \leq \rho_0 \\ 0 & \text{se } \rho(q) > \rho_0 \end{cases}$$

where

$$\rho(q) = \min \|q - q'\| \quad q' \in C_{\text{obstacle}}$$



Potential fields

Problem of local minima of the resulting function:

they can occur when the sum of repulsive forces nullifies the attractive force in points different from q_{goal}

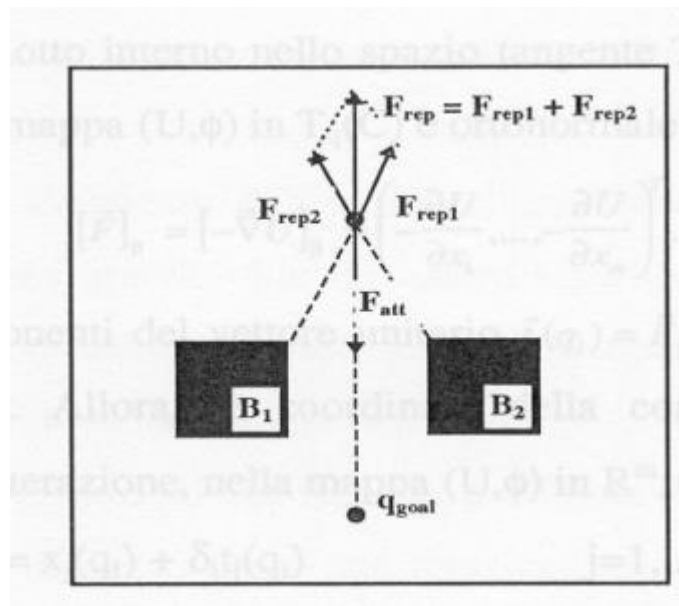

Path Planning for topological maps

Example of path on a topological map:

- Follow the wall on the right;
- Turn right;
- Follow the wall on the right;
- Stop in front of the doors;
- Enter the door and turn left
- Follow the wall on the left;
- Stop when reached the desk;



Path Planning for topological maps

- **Rules for translating a path in a sequence of commands:**
 - For the **Start** node, the command generated is **follow the wall on the right** or **follow the wall on the left**, depending on the order of the adjacent node to reach.
 - For the intermediate nodes of type **Angle**, the command generated is **change wall on the right** or **change wall on the left**.
 - For the intermediate nodes of type **Door**, the command generated is **go straight** if the robot does not have to enter the adjacent room or **enter the door and turn left (right)** if the robot has to enter the adjacent room and it has to follow the wall on the left (right).
 - For the other intermediate nodes, different from the goal node, the command is **follow the wall**.
 - When the robot reaches the **Goal** node, the command generated is **Stop**.



Path Following

- It has the role of making the robot follow the paths generated by the Path Planner

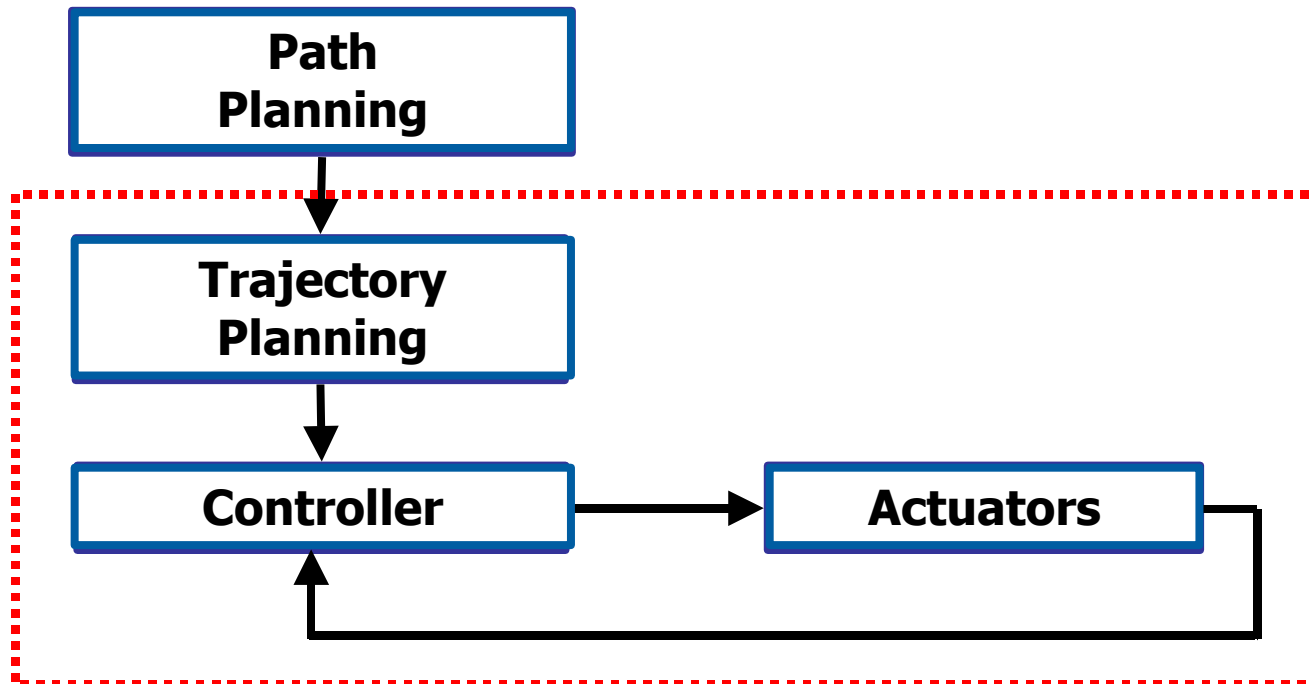

Path Following

- **Path planning:** it finds a sequence of points in space that the robot has to reach (path)
 - $(x_1, y_1, \theta_1), \dots (x_{i-1}, y_{i-1}, \theta_{i-1}), (x_i, y_i, \theta_i), \dots (x_n, y_n, \theta_n)$
- **Trajectory planning:** it finds the trajectory and the time law that the robot has to follow between each couple of points (not necessarily a linear trajectory)
- **Controller:** it makes the robot execute the trajectory found by the trajectory planner



Path planning

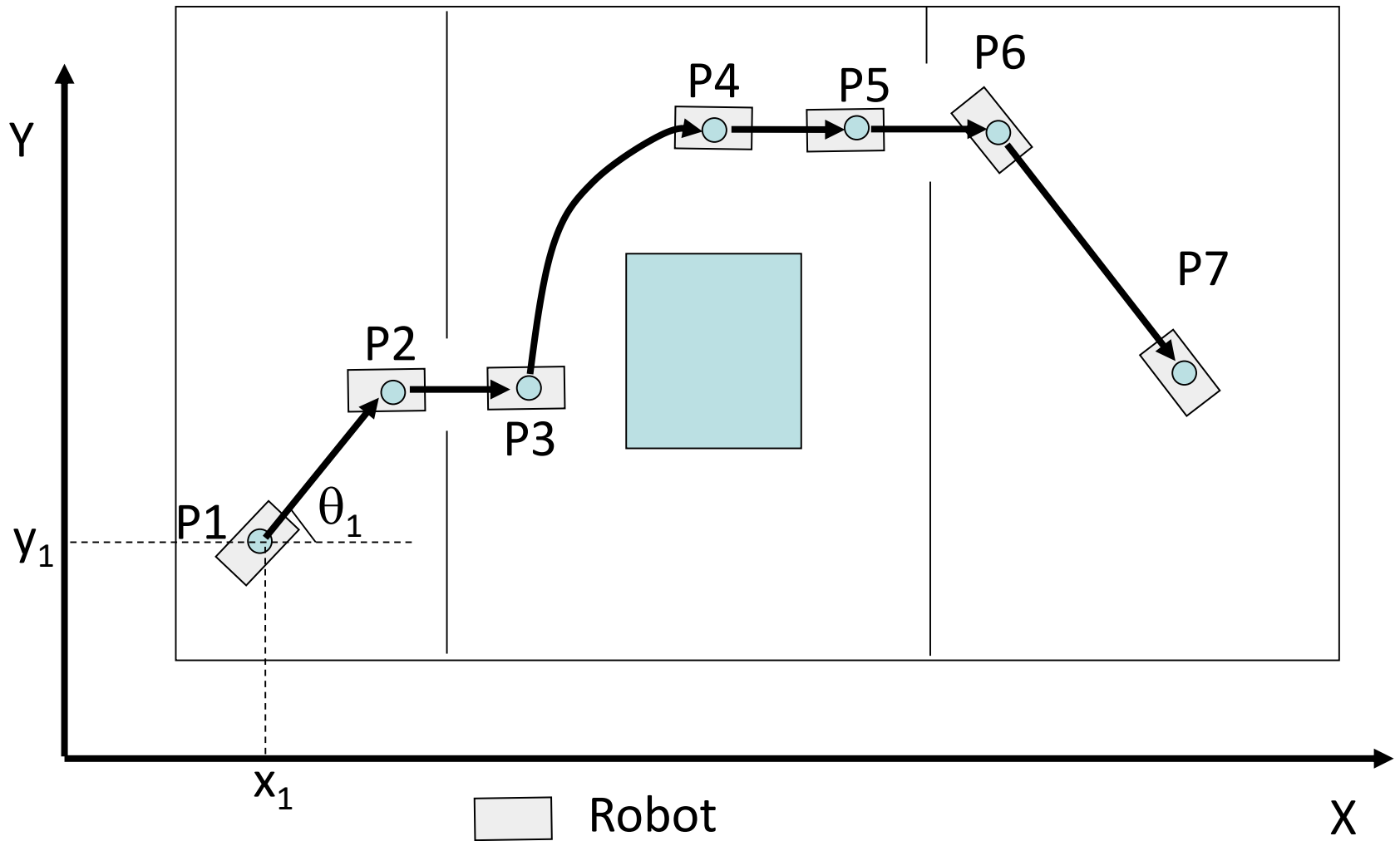

Trajectory planning

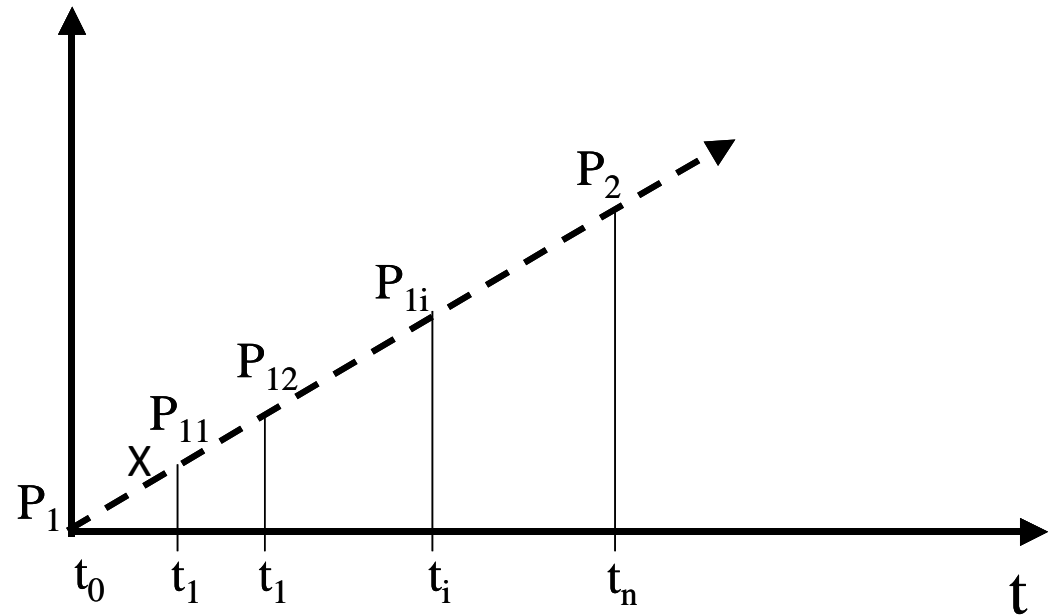
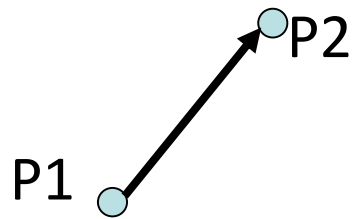
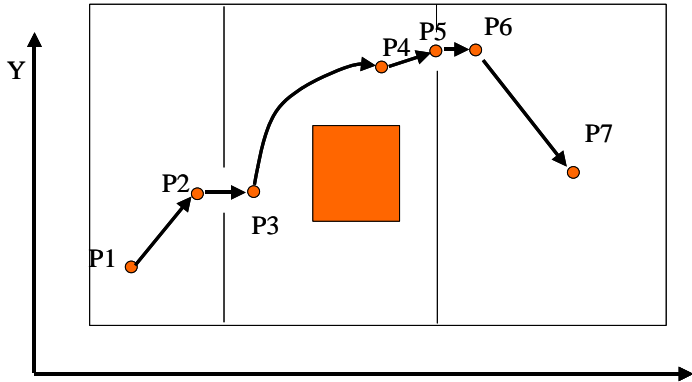

Trajectory generated by the trajectory planner



Hardware architecture of a mobile robot

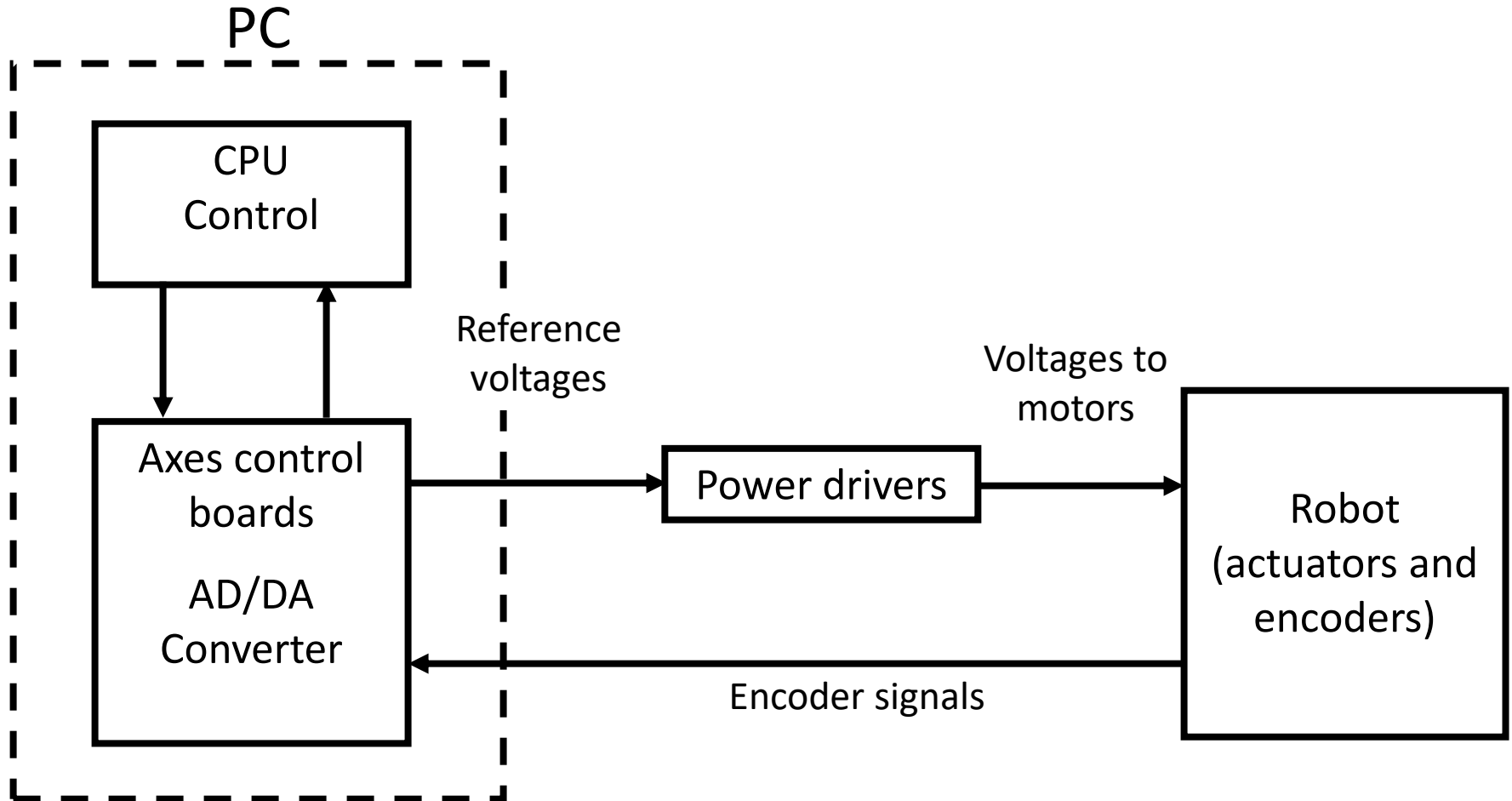

Controller

Actuator control:

- **Position control:** it consists of setting a position to reach.
The robot controller finds the velocities and the accelerations to set to the motors for reaching the desired position (inverse kinematics).
- **Velocity control:** it consists of setting a velocity and an acceleration to the wheel motors.



Position control: Proportional, Integrative and Derivative control (PID)

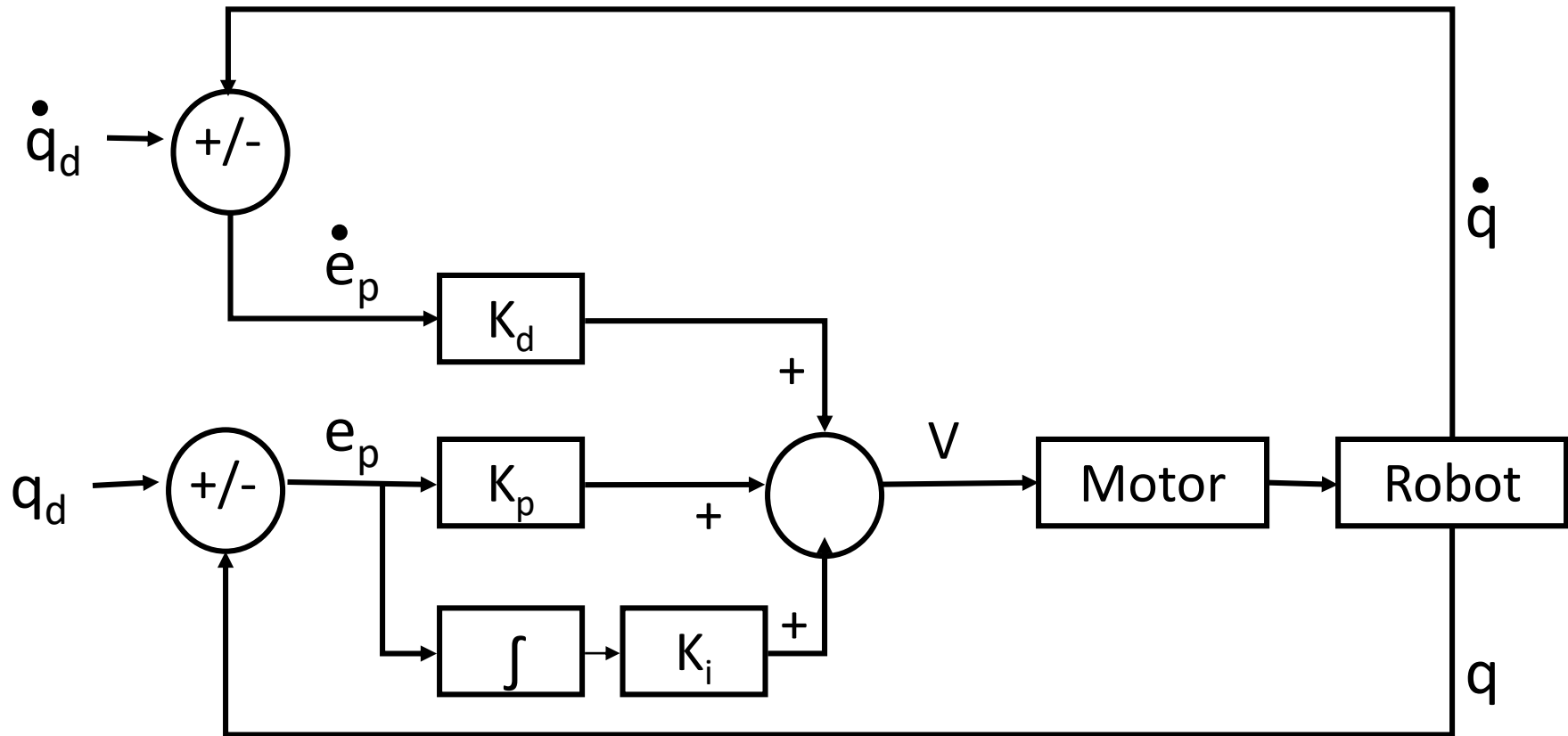

$$V = K_p e_p + K_d \dot{e}_p + K_i \int e_p$$



Path Following

- It is not always possible to follow the path planned by the Path Planner
- Problems to face:
 - Non omnidirectional mobile bases
 - Unexpected obstacles



Path Following

- **Omnidirectional mobile base:**
 - Can move in any direction
 - Can follow the trajectory given by the Path Planner

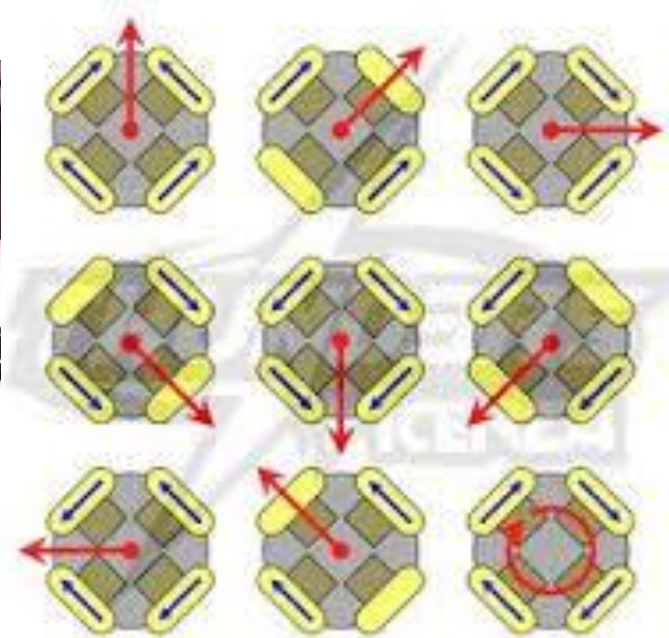
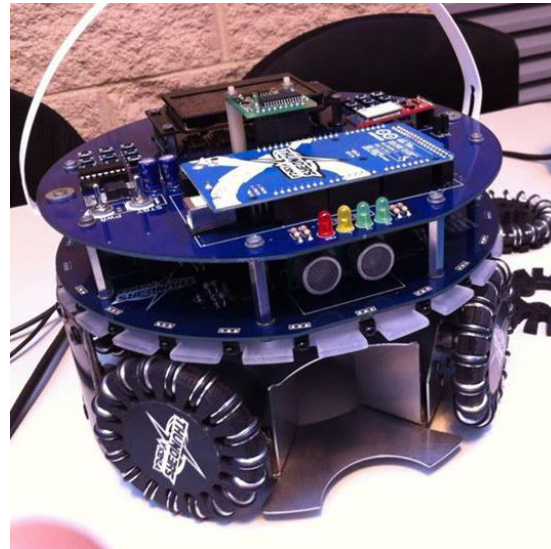

Path Following

- **Non omnidirectional mobile base:**
 - Cannot move in any direction, due to its structure (e.g. car-like robot)
 - Can not always follow the trajectory given by the Path Planner

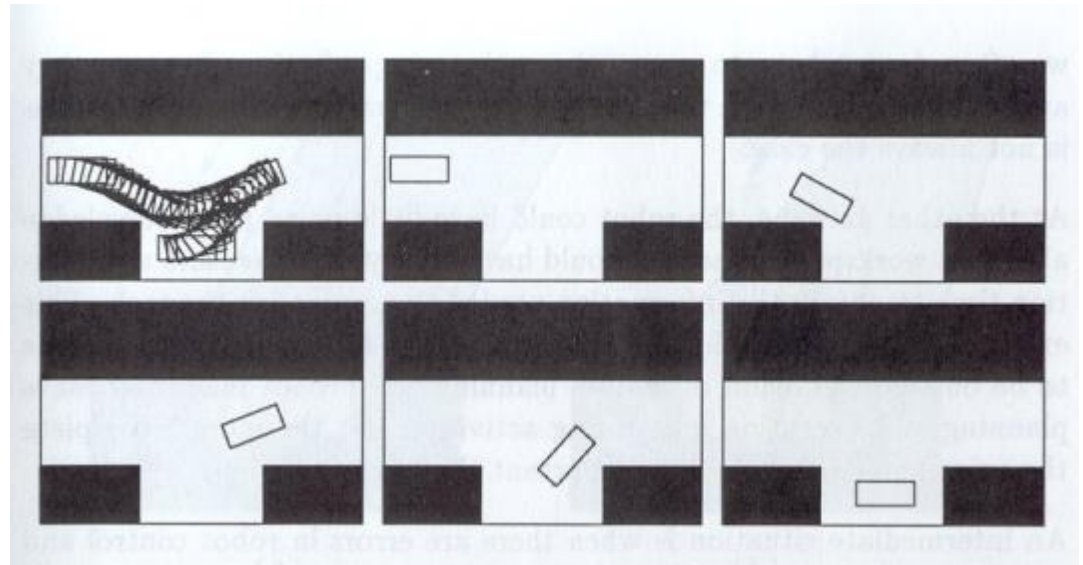
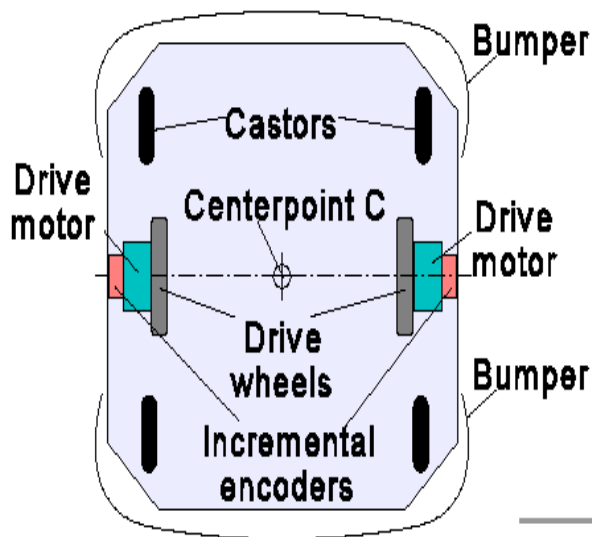

Path Following – obstacle avoidance

The problem of unexpected obstacles:

- unexpected obstacles are detected by the robot through ultrasound sensors or laser ranger
- the robot controller has to modify the trajectory to follow, in order to avoid obstacles
- obstacle avoidance techniques:
 - Based on occupancy grid
 - Based on potential fields



Systems for obstacle detection

- Sensory systems:

Ultrasound sensors

Laser Ranger

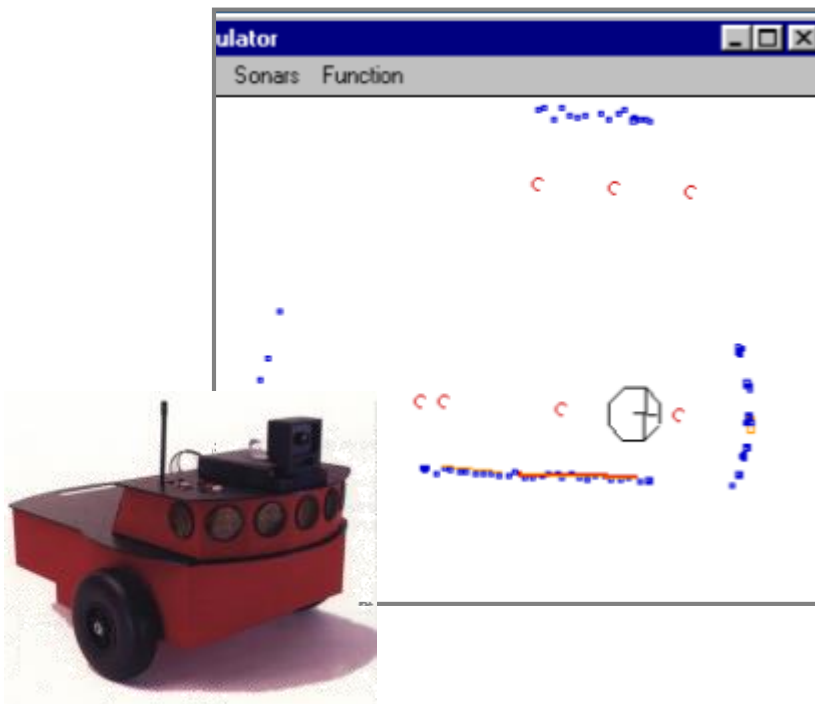

Outline of the lecture

- Fundamental problems of robot navigation
- Maps and environment models
 - Metric maps and topological maps
- Planning techniques
 - Path Planning and Path Following
- **Localization methods and systems**
 - **Odometry and systems based on active beacons and landmarks**



Localization

Localization methods

- Dead Reckoning - Odometry
- Active beacons
- Natural and Artificial Landmarks



Odometry - Dead Reckoning

- It is based on counting the robot wheel turns (measured by the encoders) during navigation
- It provides a good accuracy for small movements
- The error tends to cumulate in time with the distance run (poor accuracy for long distances).
- The odometric information is rectified by using alternative localization methods.



Odometria - Dead Reckoning

Example of odometry calculation (for small movements)

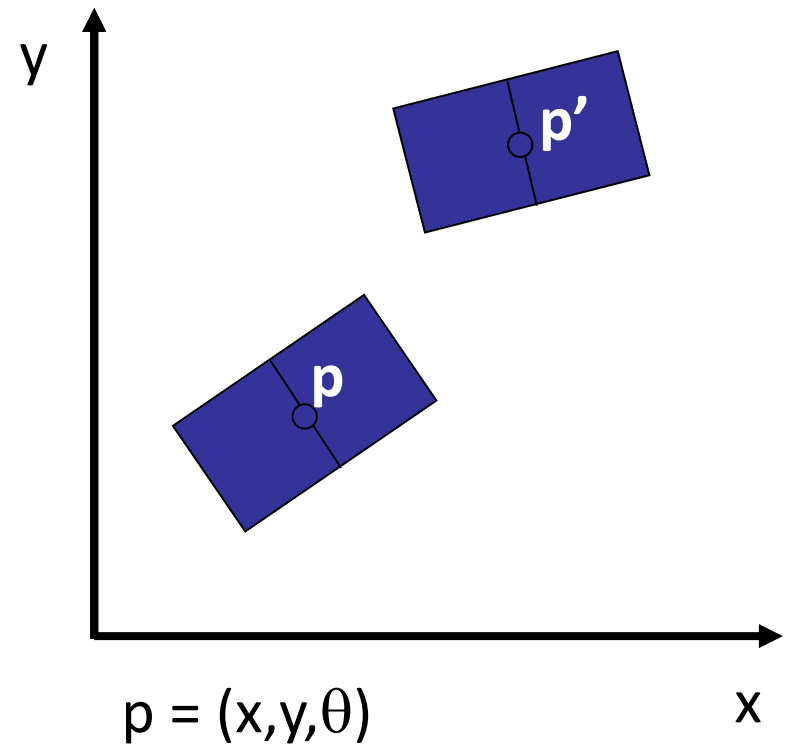
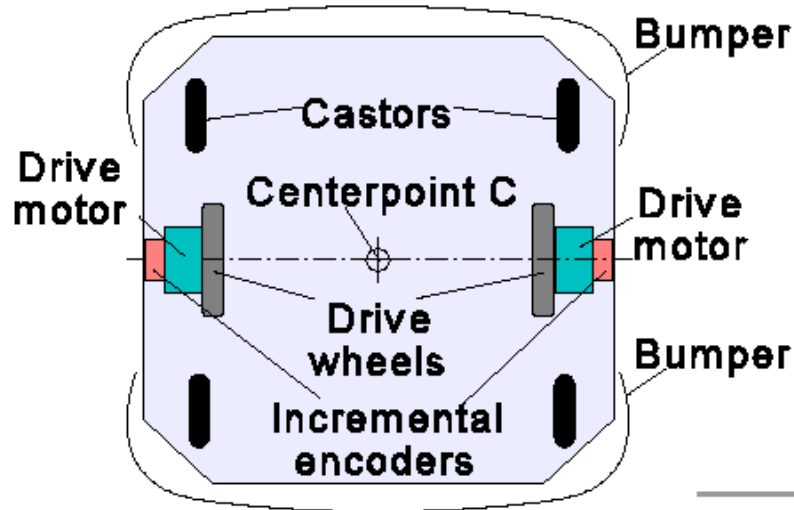

$$p = (x, y, \theta)$$

$$p' = (x', y', \theta')$$



Odometry - Dead Reckoning

In a time interval T , the right and left wheel encoders measure an increase of N_L e N_R , respectively

$$C_m = \pi D/n C_e$$

where

C_m = conversion factor that translates the encoder steps in linear distance run by the wheels

D = nominal wheel diameter

C_e = encoder resolution

n = reduction ratio between motor (where the encoder is) and wheel



Odometry – dead reckoning

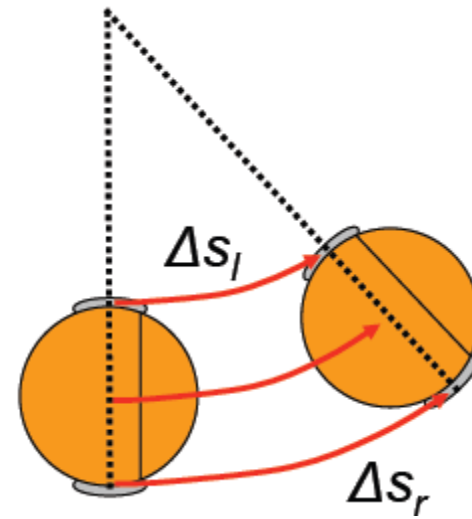
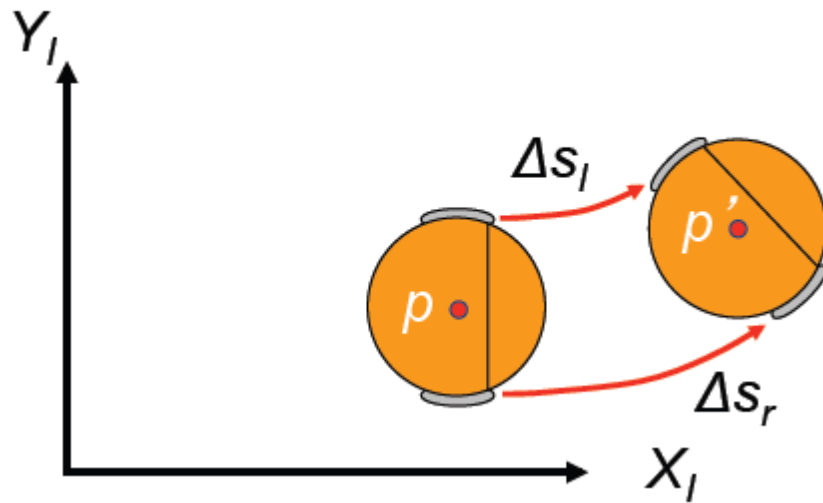

Odometry - Dead Reckoning

The distance run by the right and left wheels, ΔS_L e ΔS_R , can be computed as

$$\Delta S_{l/r} = C_m N_{L/R}$$

The distance run by the robot centre ΔS is:

$$\Delta S = (\Delta S_l + \Delta S_r)/2$$

while the robot orientation angle increases of

$$\alpha = \arctg (\Delta S_r - \Delta S_l)/2L$$

where $2L$ is the distance between the wheels (ideally measured as the distance between the points of contact of the wheels on the terrain)

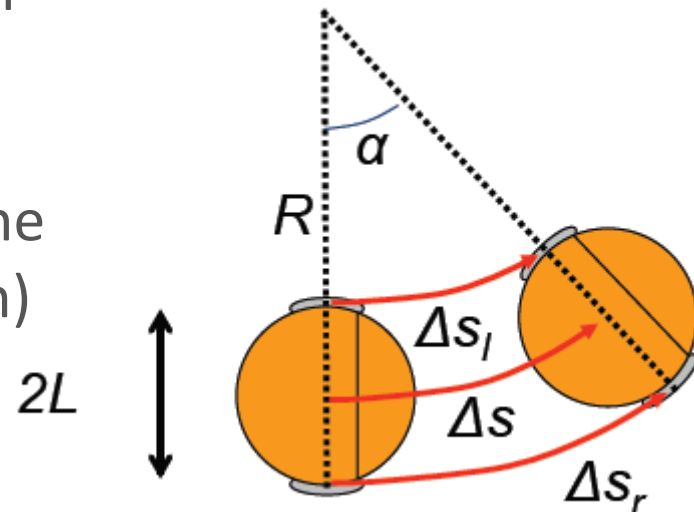

Odometry – dead reckoning

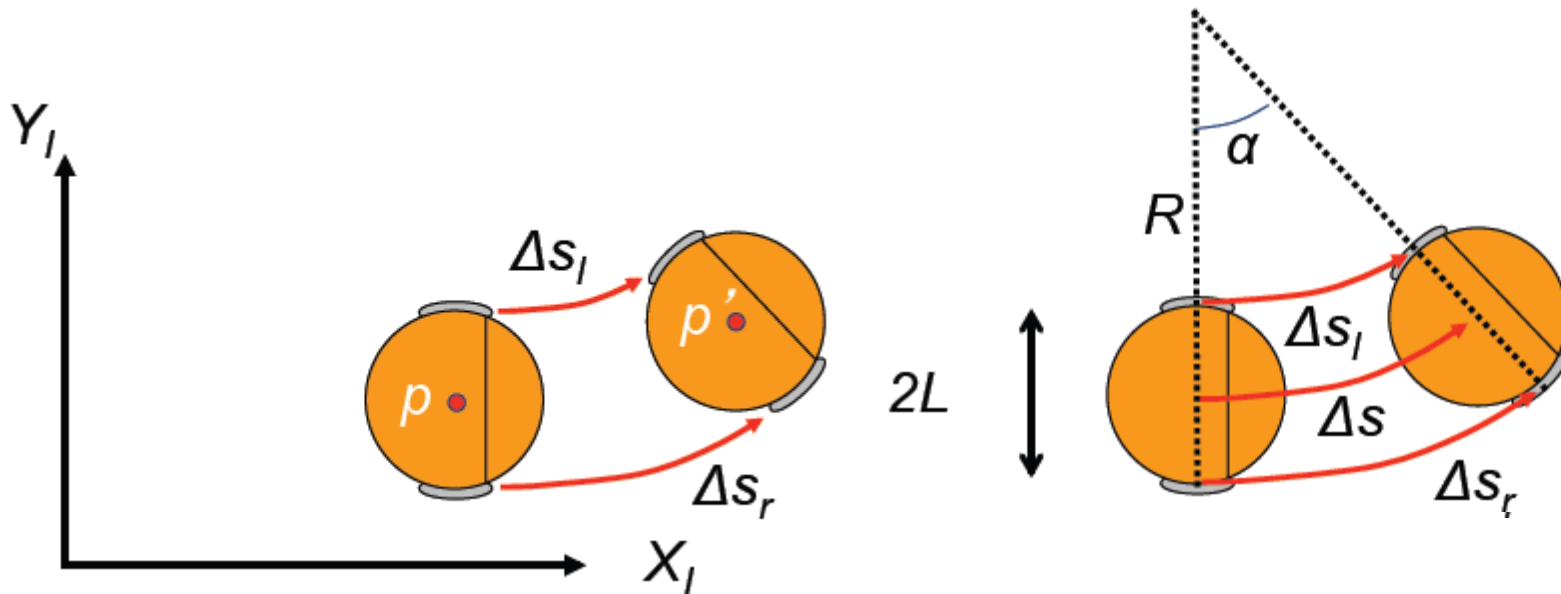

The new robot position p' is:

$$\theta' = \theta + \alpha$$

$$x' = x + \Delta S \cos \alpha$$

$$y' = y + \Delta S \sin \alpha$$

where (x, y, θ) was the position of the robot centre p



Odometry - Dead Reckoning

Odometric errors are of two types:

- **Systematic Errors**, due to:
 - different diameters of the two wheels
 - actual size of wheels different from nominal size
 - misalignment of the wheels
 - encoder resolution
- **Non systematic errors**, due to:
 - movements on uneven terrains
 - movements on unexpected objects
 - wheel slippage due to
 - high accelerations
 - slipping terrains
 - external forces (obstacles)



Odometry - Dead Reckoning

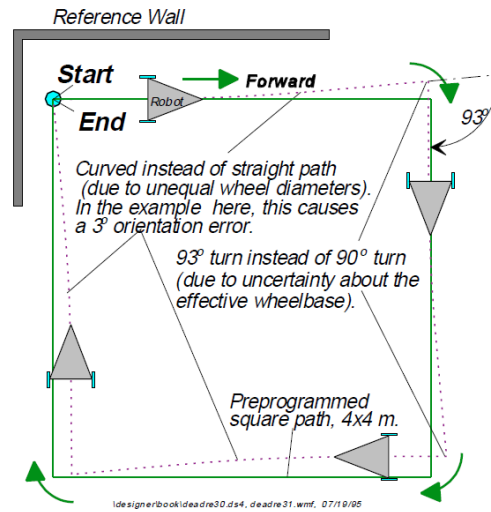
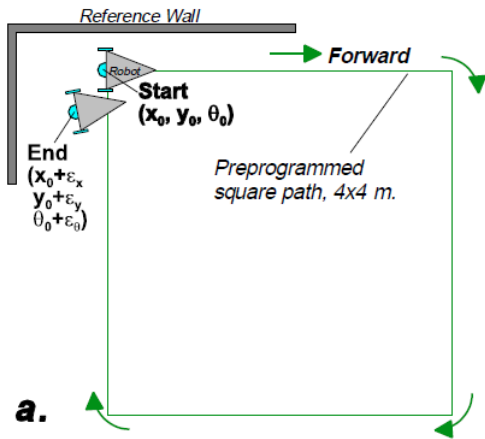

The effect of the two dominant systematic dead-reckoning errors E_b and E_d . Note how both errors may cancel each other out when the test is performed in only one direction.

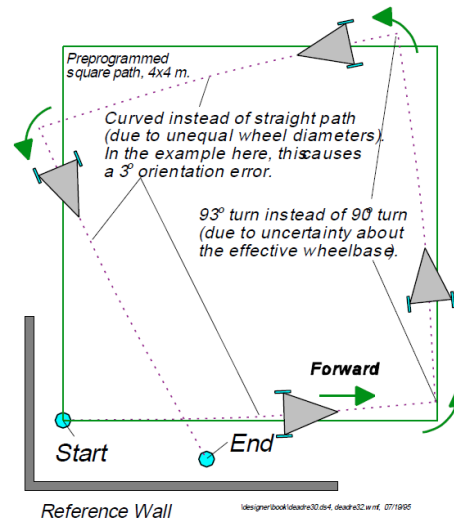
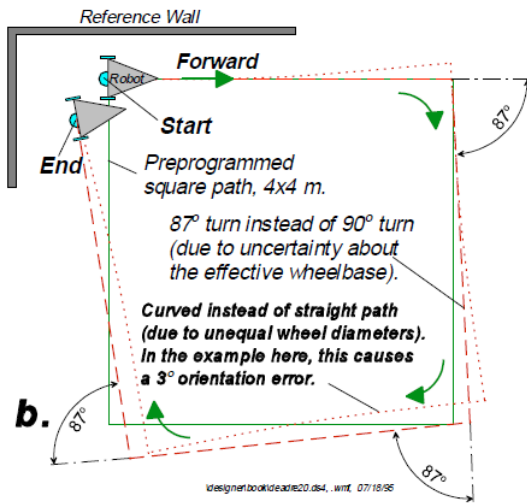

The effect of the two dominant systematic odometry errors E_b and E_d : when the square path is performed in the opposite direction one may find that the errors add up.

The unidirectional square path experiment.

a. The nominal path.

b. Either one of the two significant errors E_b or E_d can cause the same final position error.



Active beacons

- Localization systems based on active beacons are composed of a set of receiver/transmitter devices (beacons) whose absolute position is known and which are detectable by a sensor on-board the robot



Active beacons

The localization algorithm is based on the triangulation procedure:

- A rotating unit on the robot can measure the angles $\lambda_1, \lambda_2, \lambda_3$
- By knowing the position of the 3 beacons, it is possible to derive the robot absolute position (X, Y, θ) by triangulation

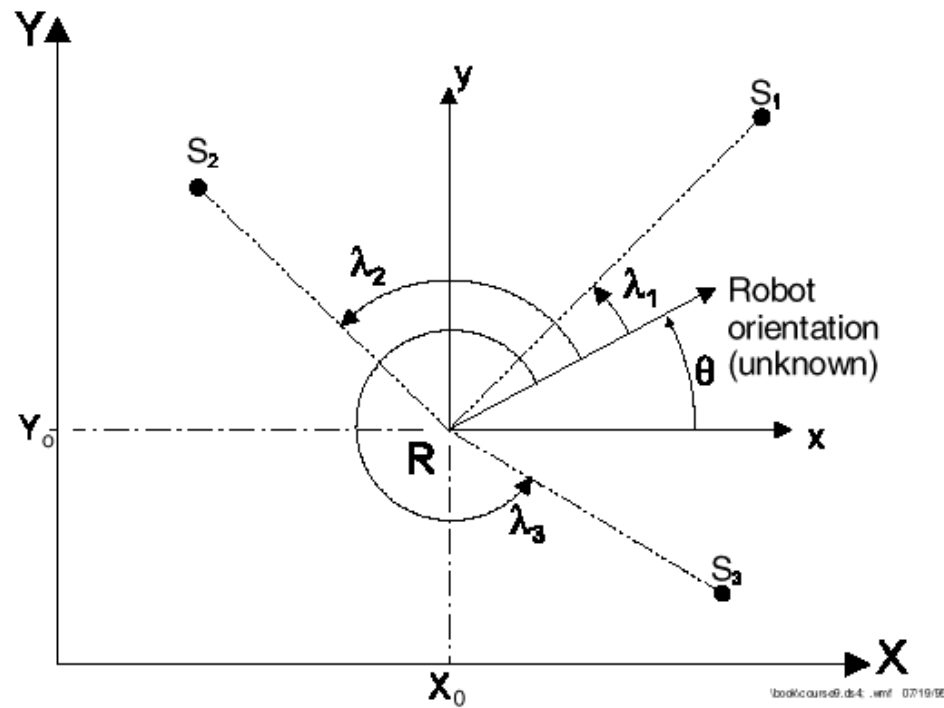

Localization systems based on maps

- Localization systems based on maps, or *map matching*, use one or more sensory systems for building a local map.
- The local map is compared to a global map previously stored.
- If a matching is found, the robot finds its position and orientation in space.
- A map can be a CAD model or it can be built using the robot sensory system.



Localization systems based on maps

To simplify the problem, the current robot position estimated by odometry can be used.

Steps of the localization procedure:

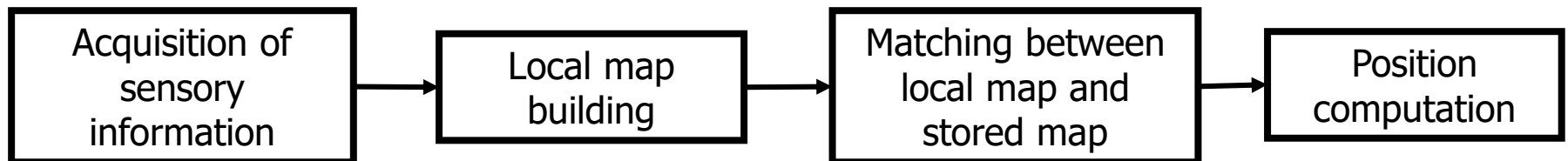

Localization systems based on maps

- Sensory systems:

Ultrasound sensors

Laser Ranger

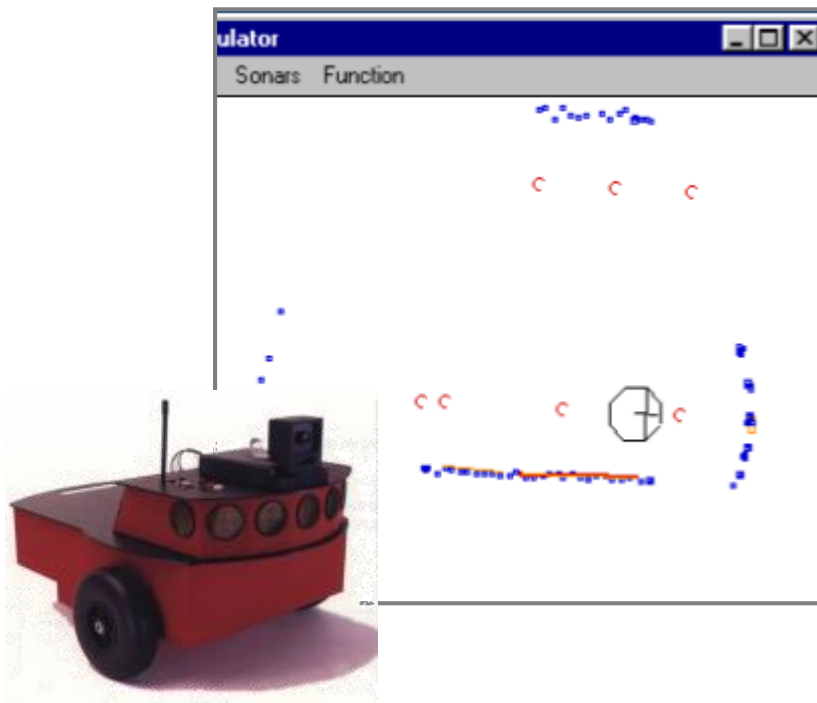

Localization systems based on maps

Mapping techniques:

- Correlation

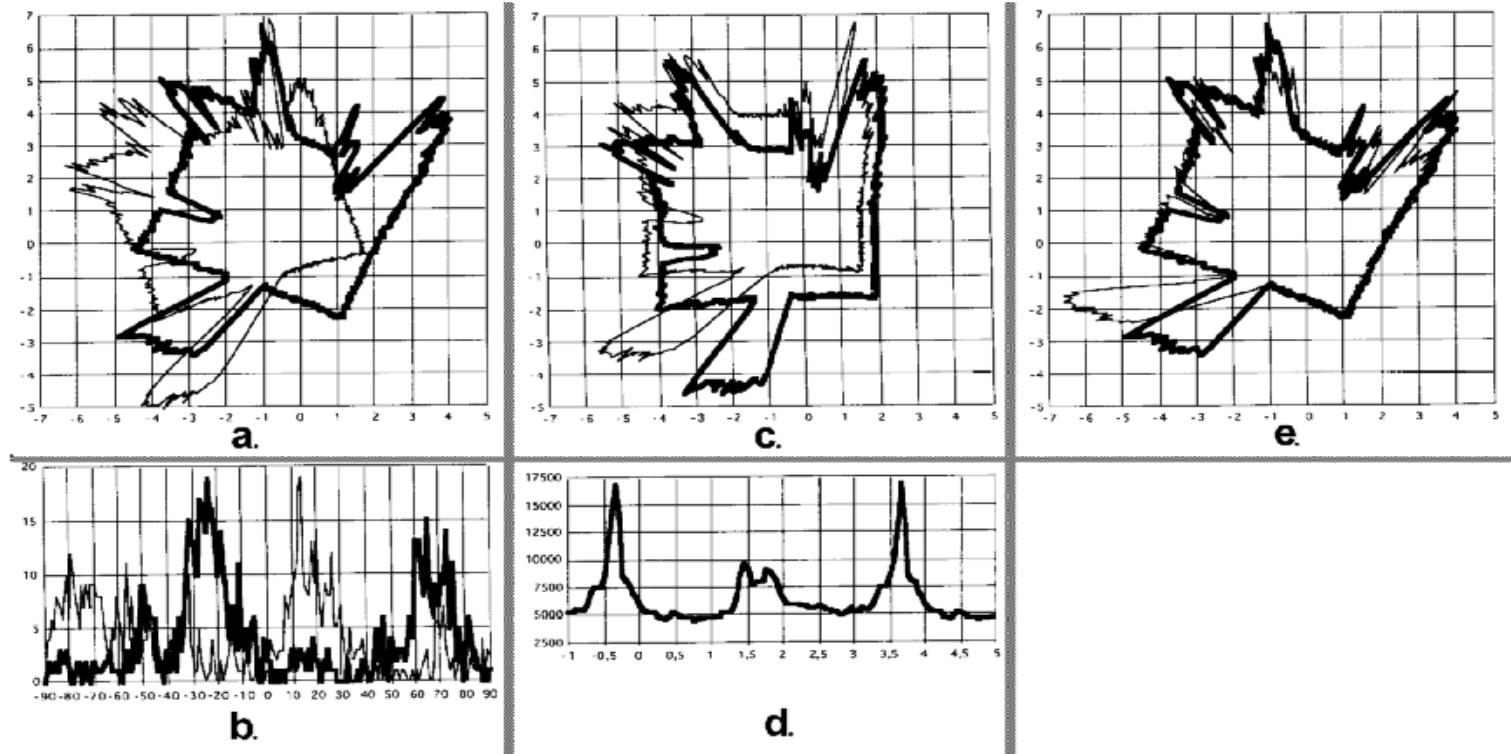

Landmarks

- Landmarks are characteristic shapes that the robot can recognize by using its sensory systems.
- Landmarks can be geometric shapes (e.g. boxes, lines, circles, ..) and they can contain additional information (e.g. bar-code).
- Landmarks are chosen so as to be easily recognised by the robot.
- The position and the characteristics of the landmarks need to be stored in the robot database.



Landmarks

To simplify the problem, the current robot position estimated by odometry can be used.

Steps of the localization procedure:

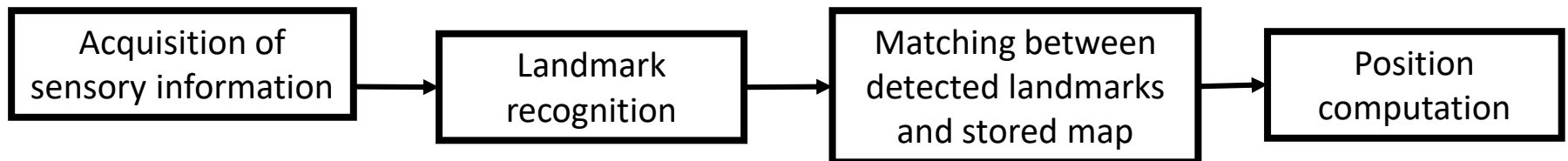

Landmarks

- Landmarks can be divided in
 - **Natural Landmarks:** objects already present in the environment, with specific characteristics (e.g. lights, corridors, doors, etc.).
 - **Artificial Landmarks:** objects or markers purposively developed and placed in the environment to allow robot localization.



DustCart hybrid architecture

3 layers:

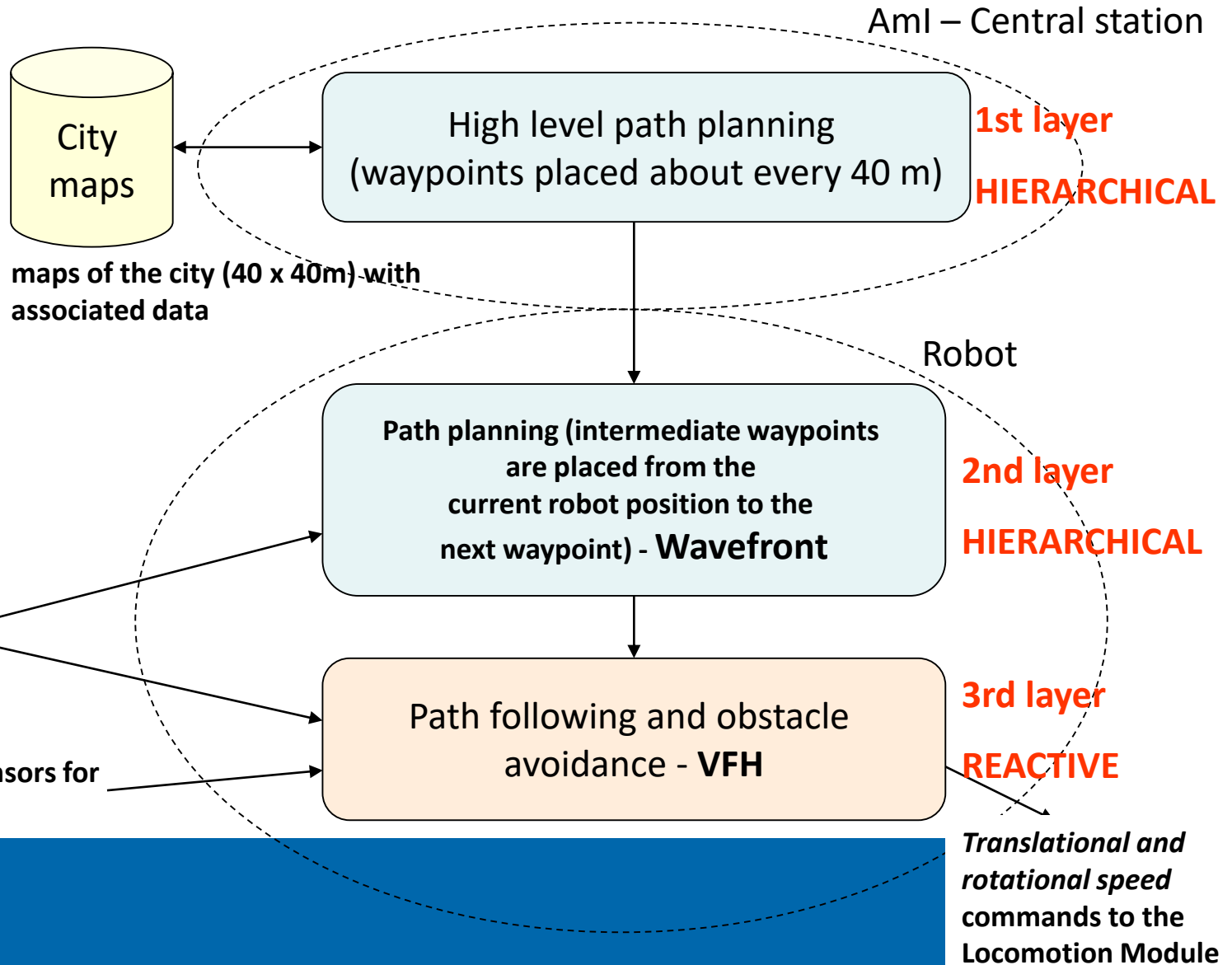



DustCart



<https://www.youtube.com/watch?v=gEy91PGGLR0>

<https://www.youtube.com/watch?v=ftouPdU1-Bo>



Underwater robots

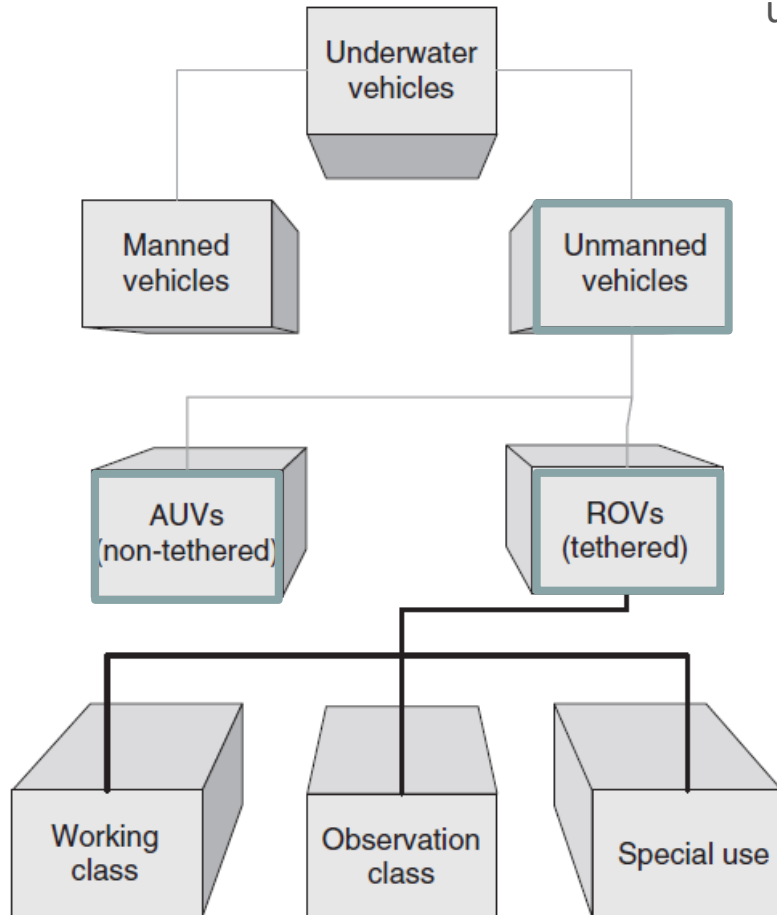

According to the US Navy's UUV Master Plan, an 'unmanned undersea vehicle' is defined as a:

- *Self-propelled submersible whose operation is either*
 - *fully autonomous (preprogrammed or real-time adaptive mission control) or*
 - *under minimal supervisory control and*
 - *is untethered except, possibly, for data links such as a fiber-optic cable.*
- *The civilian moniker for an untethered underwater vehicle is the AUV, which is free from a tether and can run either a pre-programmed or logic-driven course.*
- *The difference between the AUV and the ROV is the presence (or absence) of direct hardwire communication between the vehicle and the surface.*
- *However, AUVs can also be linked to the surface for direct communication through an acoustic modem, or (while on the surface) via an RF (radio frequency) and/or optical link.*



Underwater robots

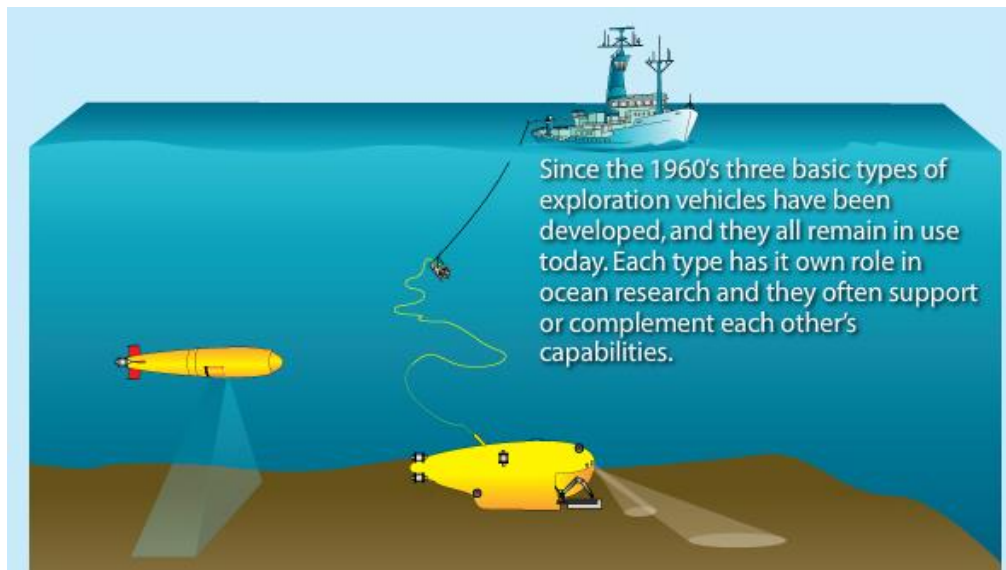

AUV Autonomous Underwater Vehicle

Has:

- Thrusters
- Batteries
- Navigation
- Onboard computer
- Pressure housing

Does not have:

- Tether
- Manipulator arm
- Sample basket
- Personnel sphere

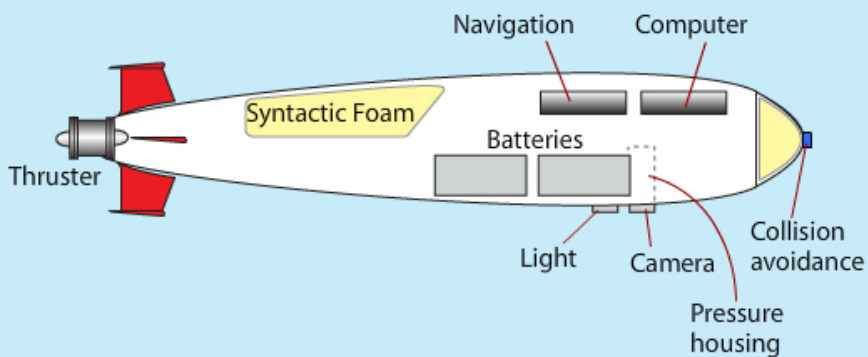

ROV Remotely Operated Vehicle

Has:

- Thrusters
- Navigation
- Sample basket

Does not have:

- Personnel sphere
- Batteries

- Tether
- Manipulator arm
- Onboard computer
- Cameras

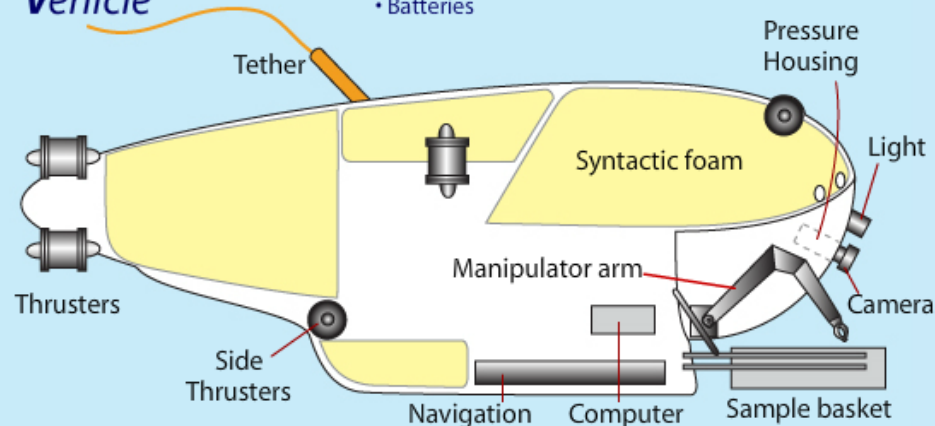

Underwater robot kinematics

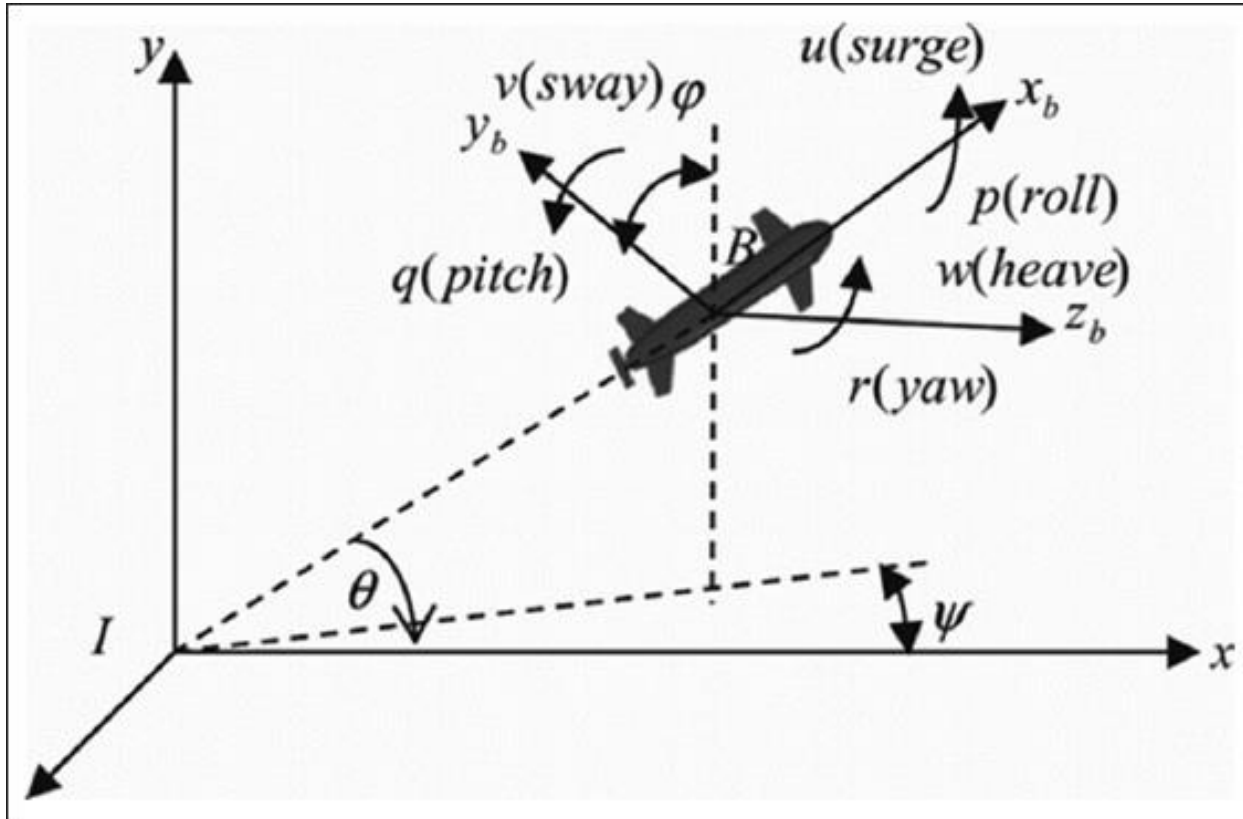

- fixed reference frame (inertial reference frame) I
- the body-fixed frame (motion reference frame) B

DOFs of a rigid body in 3D space: 6 DOFs:

- 3 TRANSLATIONAL DOF: x, y, z
- 3 ROTATIONAL DOF: $roll, pitch, yaw$



Underwater robot trajectory

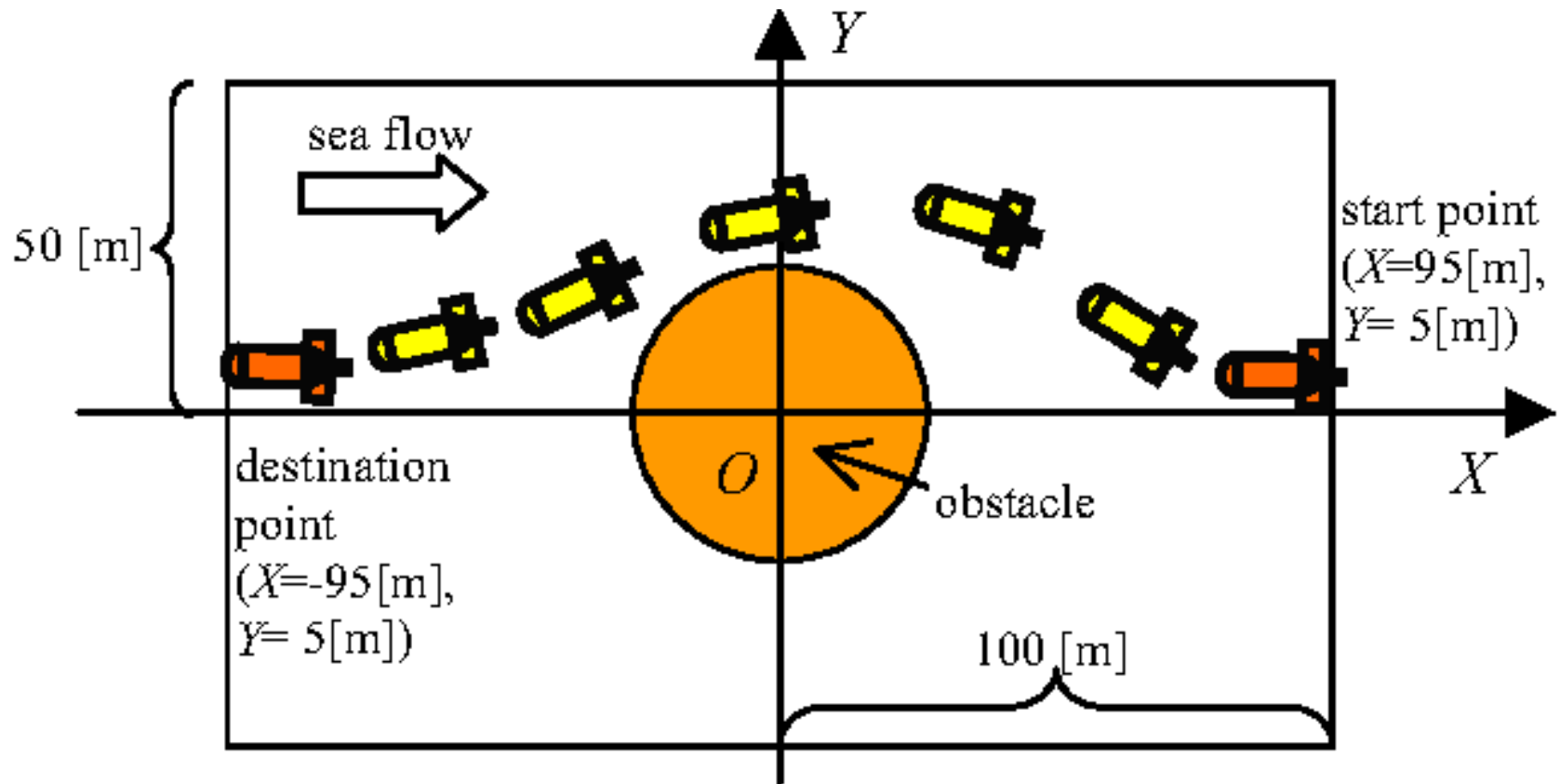

Underwater robot trajectory

Defining Obstacles

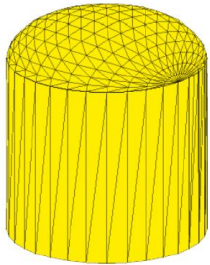

E Storage Structure
(d:40m h:70m)

- Obstacles designed in Rhino with realistic specs
- Imported in Matlab and defined the **convex hull**
- Vertexes are the Voronoi diagram generator points



A Gas Compression Template
(w:74m d:45m h:26m)

B Production Template
(w:34m d:12m h:10m)



C Power Distribution
(w:20m d:10m h:10m)



D Docking Station
(w:6m d:6m h:8m)

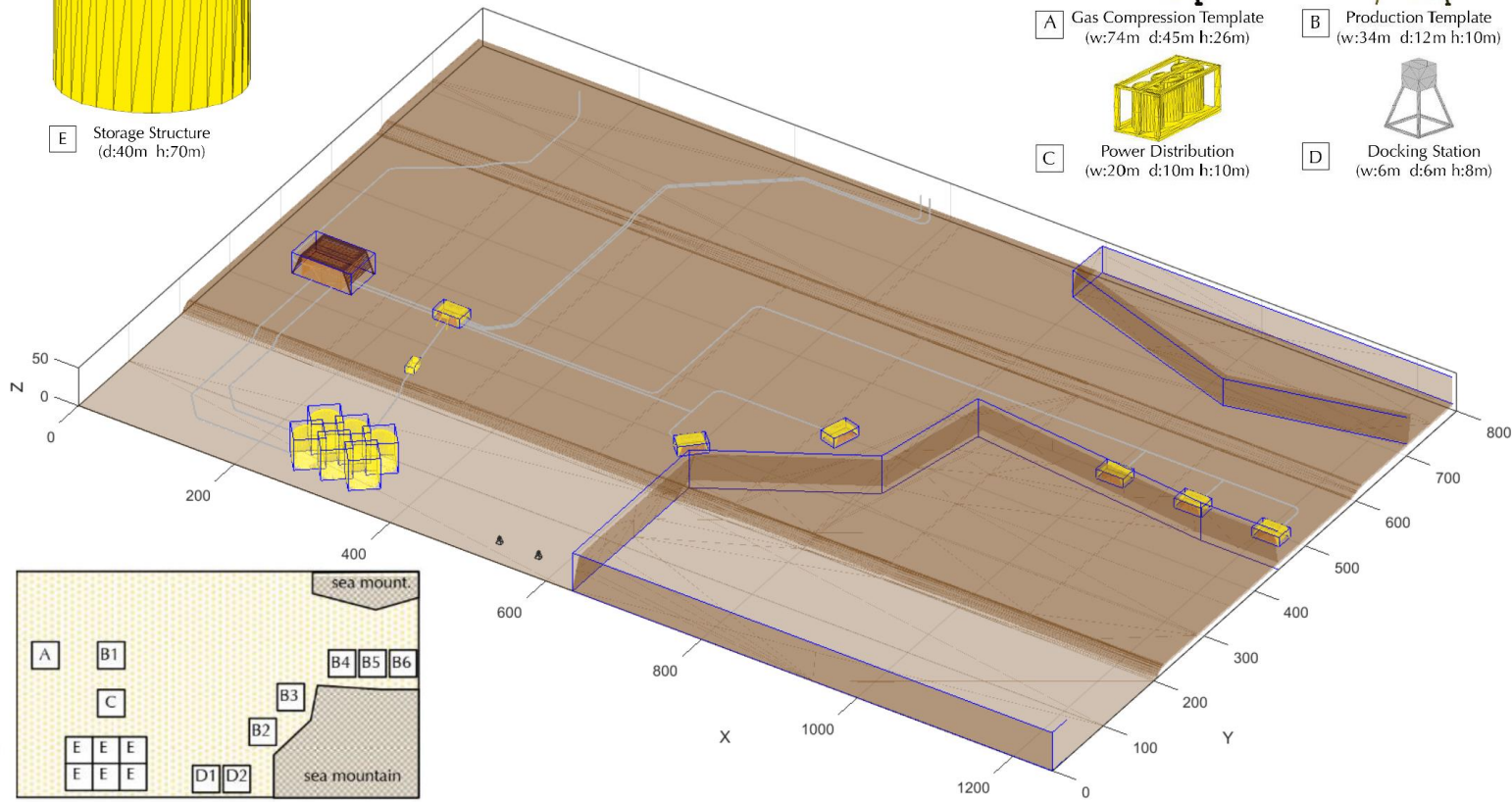

Underwater robot trajectory

Defining a Road Map

- Red dots are the **generator points** of the Voronoi diagram;
- **Random generator points** are created on the edges of the SPS, to constraint the Voronoi diagram;
- Red lines are the Voronoi edges;
- Starting and Final points are defined and connected to the closes vertexes of the roadmap.

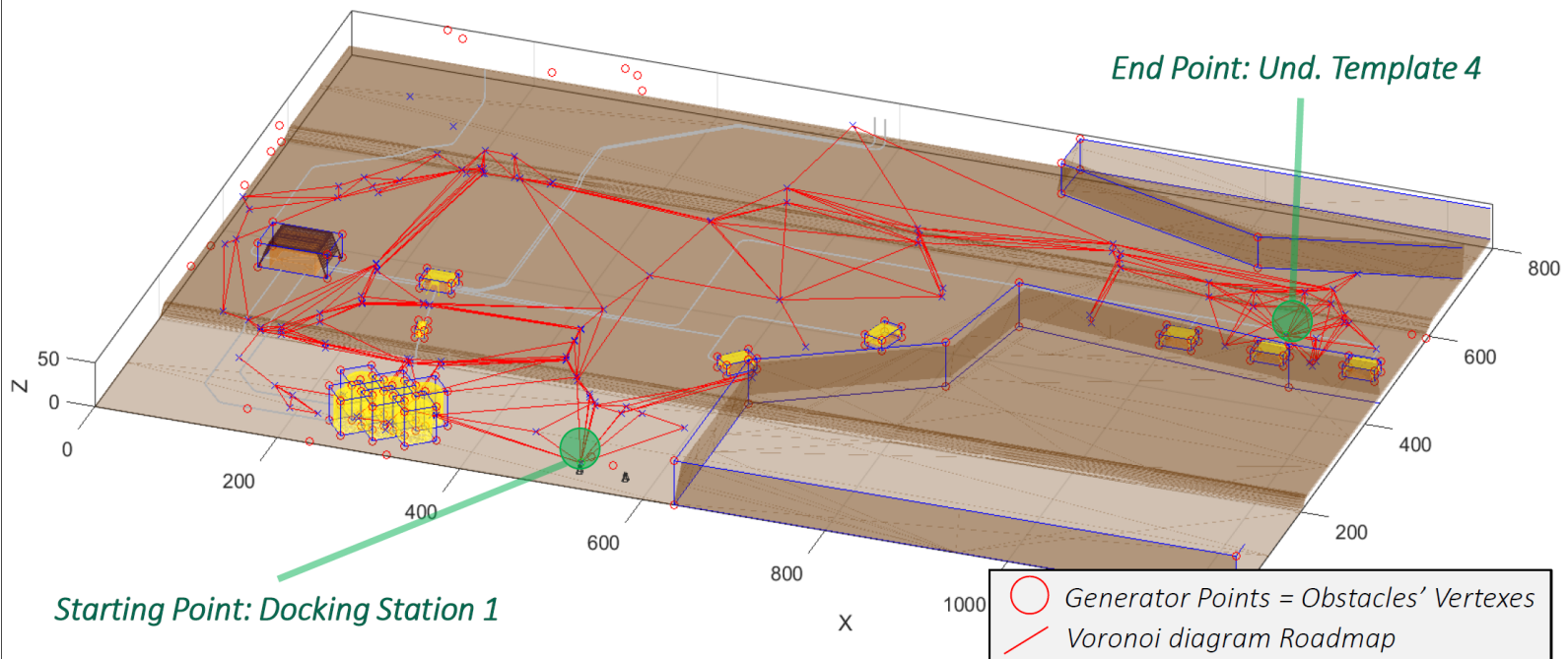

Underwater robot trajectory

Shortest Path

- Dijkstra Algorithm (with Yan modification) allows to find the ***n*-th-shortest path**;
- **Clearance constraints** (minimum distance to the obstacles) must be calculated and checked;
- Further **simplifications on the path** are done IF the clearance to obstacles does not decrease.

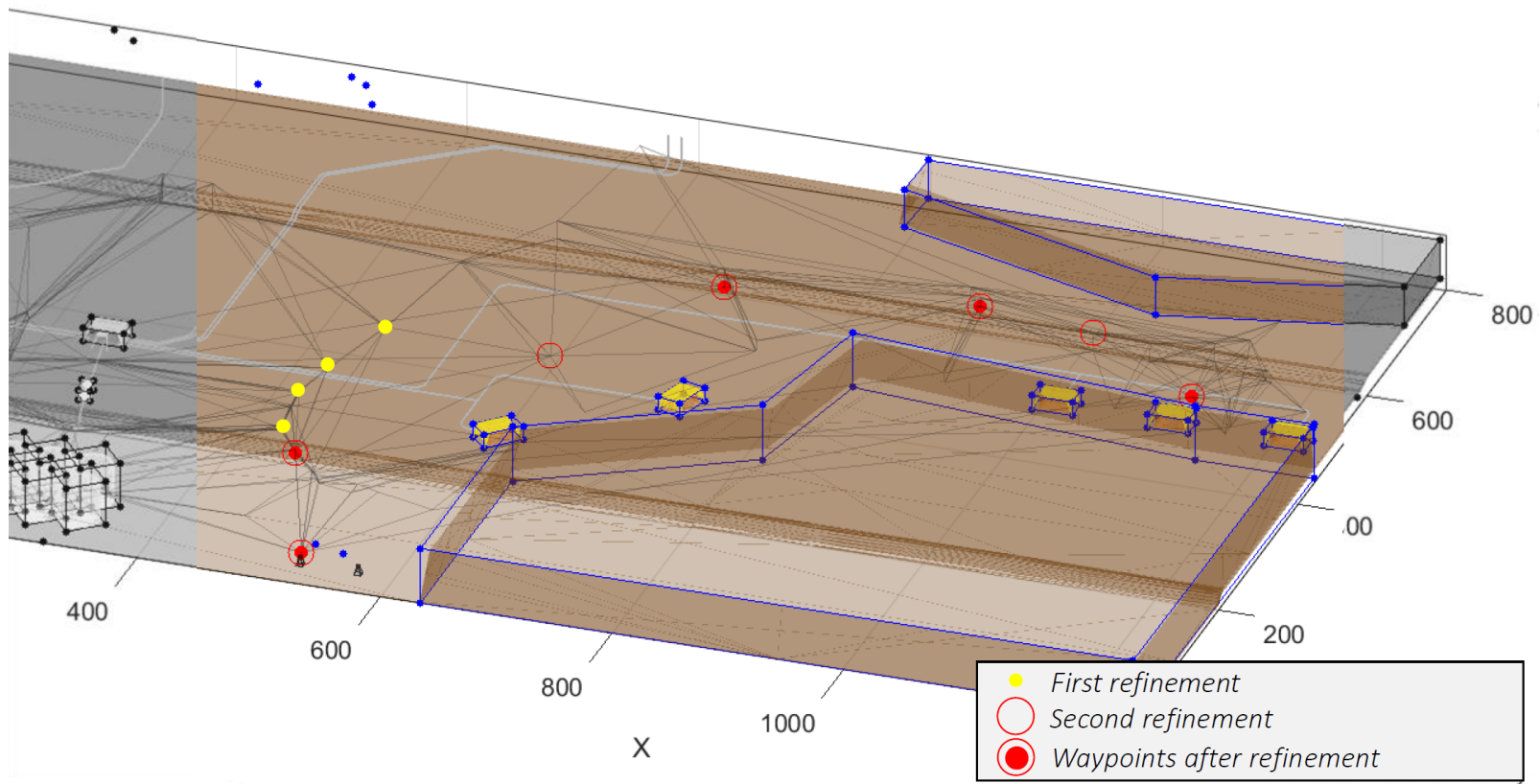

Underwater robot trajectory

Final 3D Path

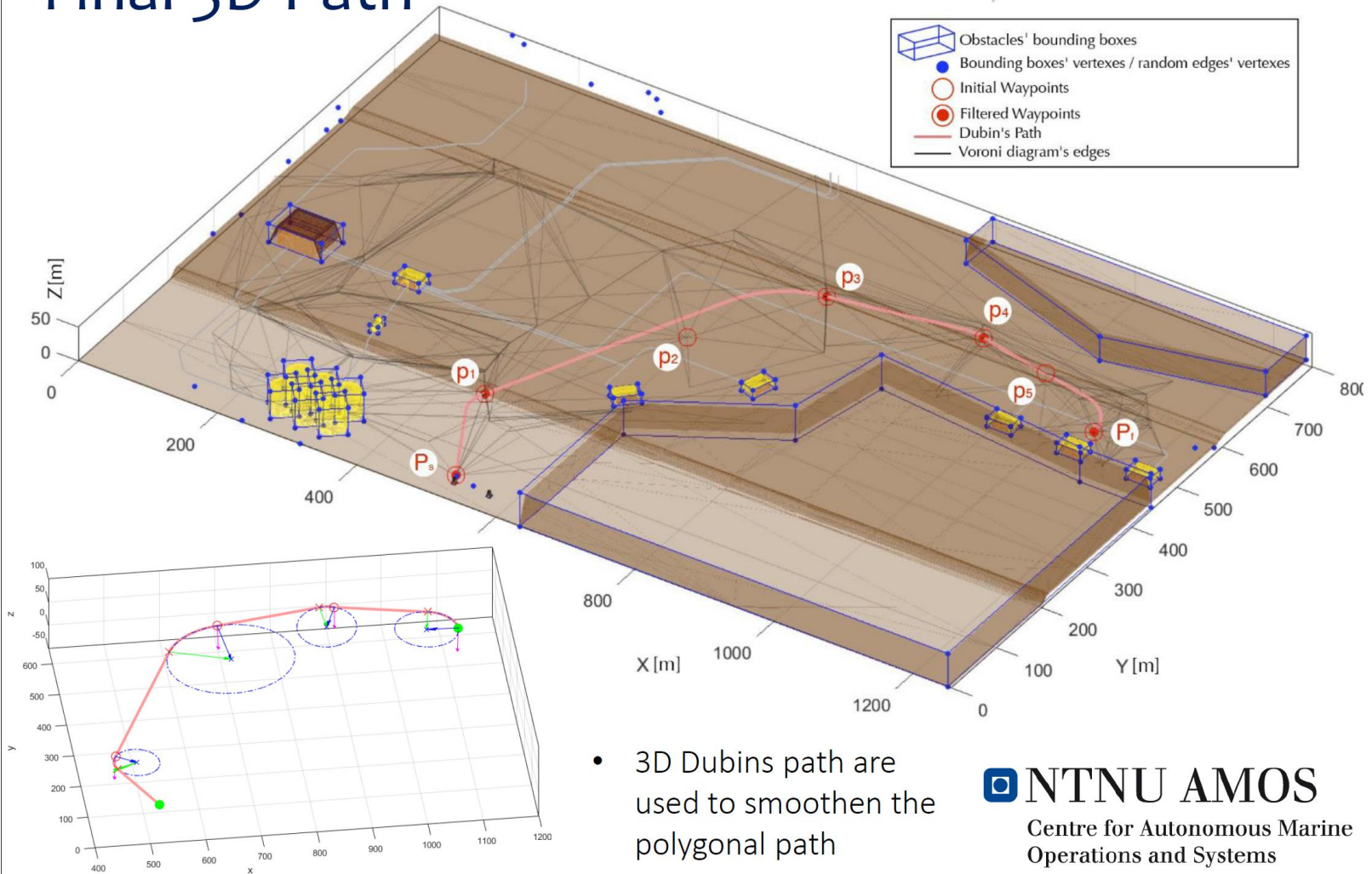

Underwater robot trajectory

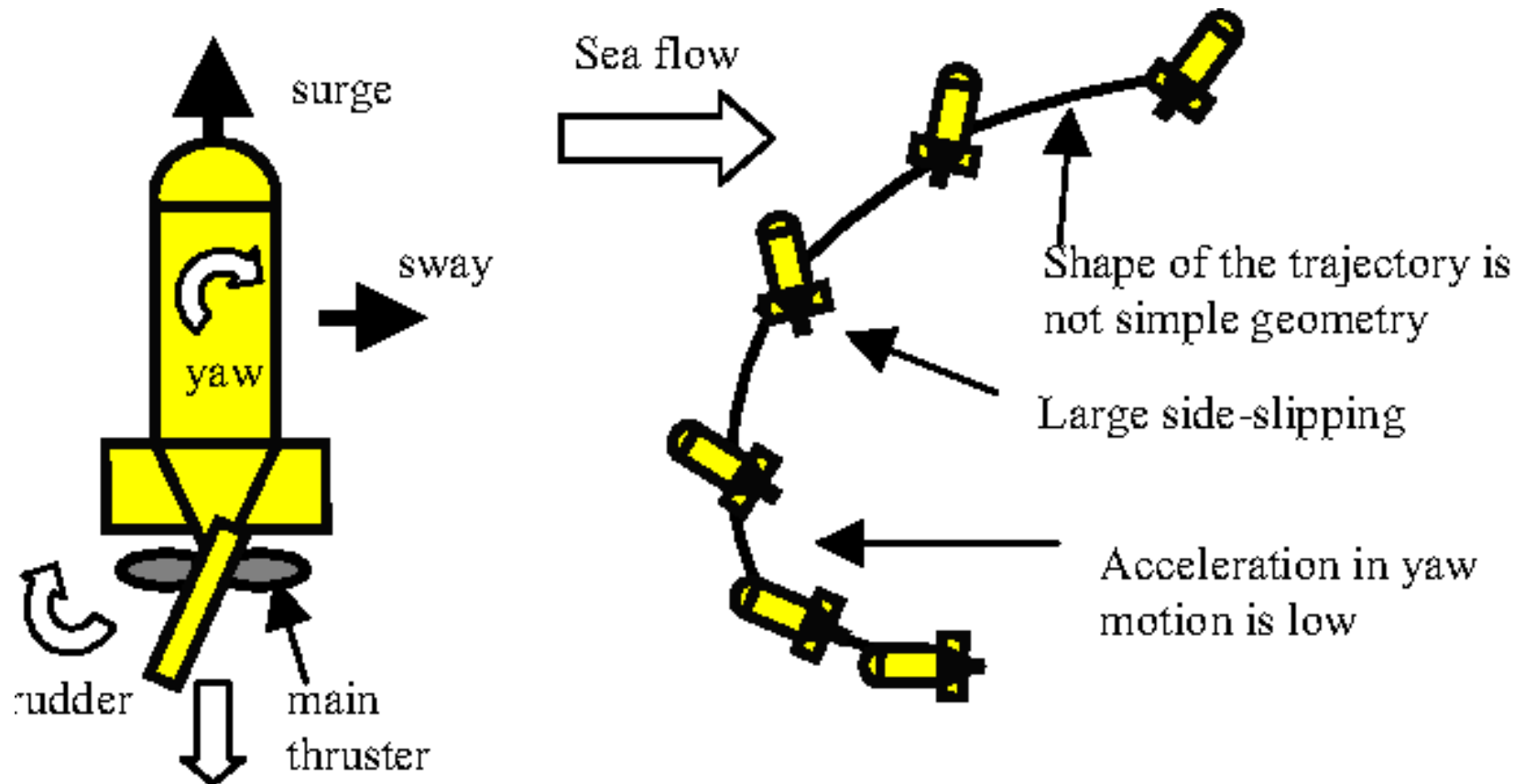

Fig. 1. Configuration of a typical under-actuated underwater vehicle and its motion in strong sea flow.

