

1 Componente memoria

martedì 3 ottobre 2017 16:11

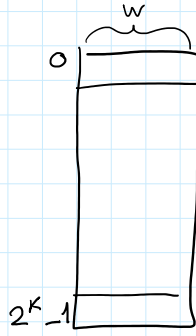

Memoria de 4 posizioni de 1 bit

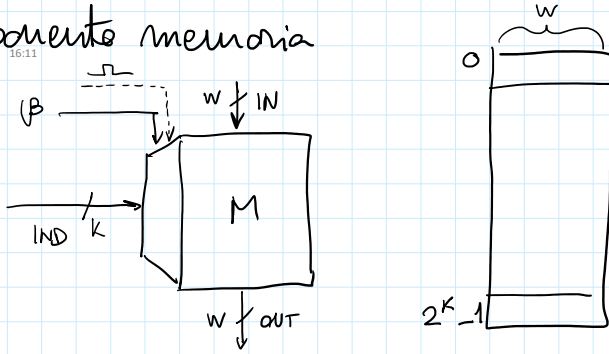
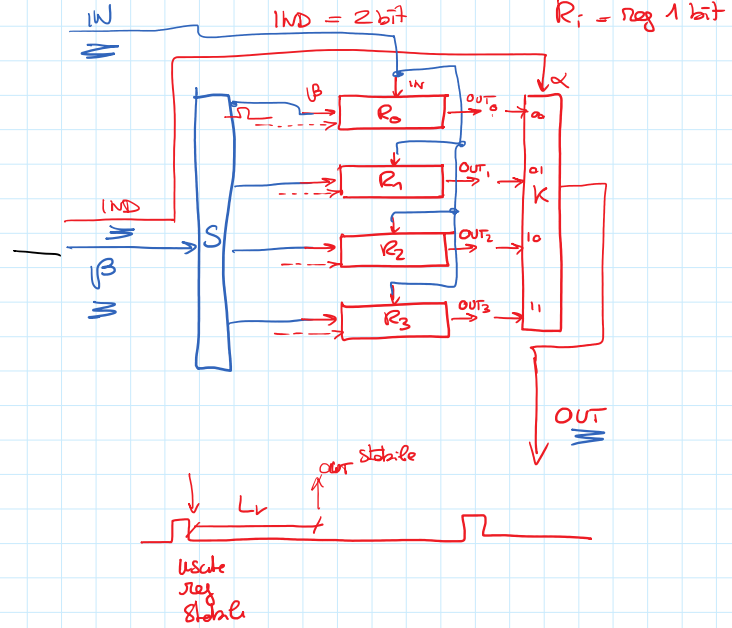

quando $\beta = 1$ e decod. alto

$$IN \rightarrow POS[IND]$$

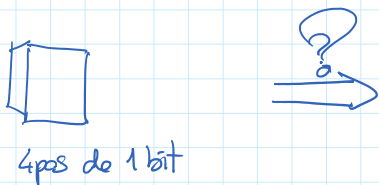
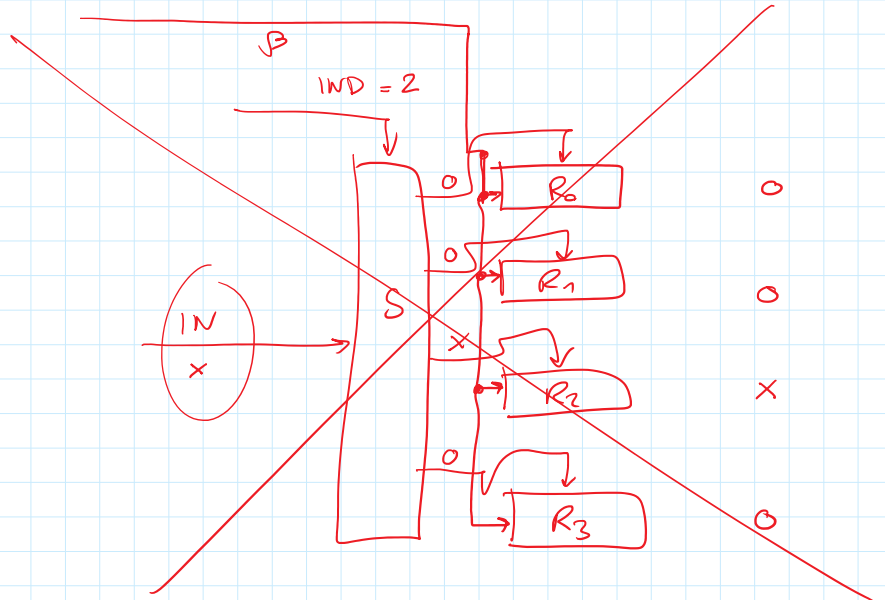
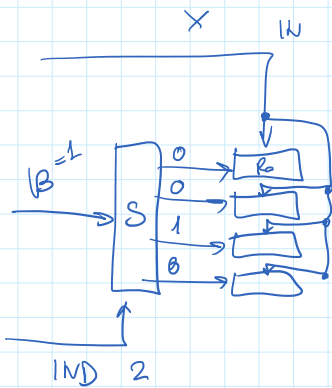
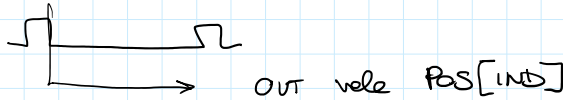

4 pos de 1 bit

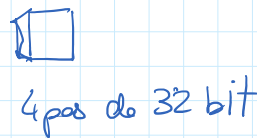

4 pos de 32 bit

reg de 1 bit

reg de 32 bit

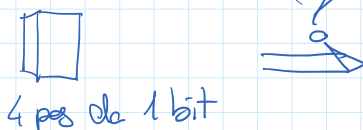

4 pos de 1 bit

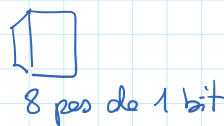

8 pos de 1 bit

k de 8 e S de 8 posizioni!

tempo di accesso ?

M t_a tempo di accesso

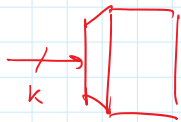

2^k posizioni

legge
scrive

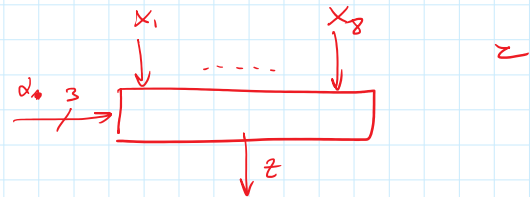
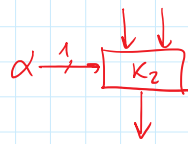
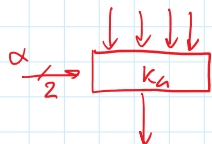
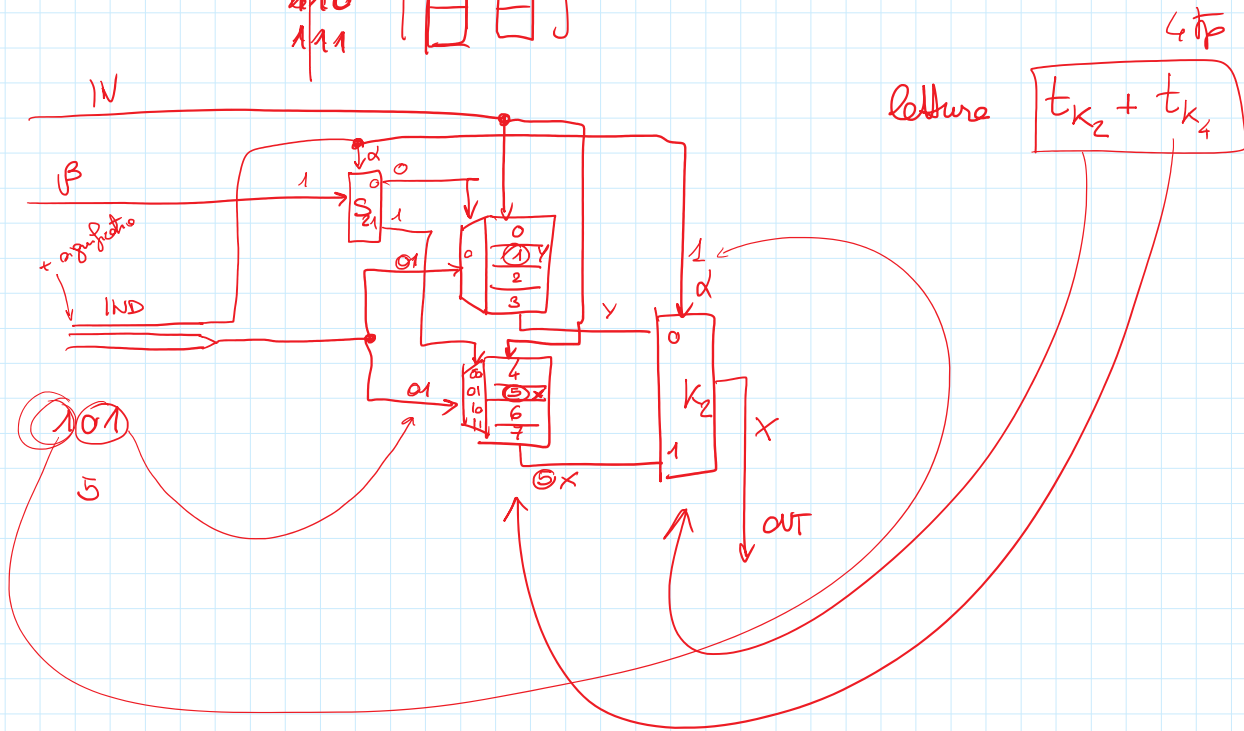
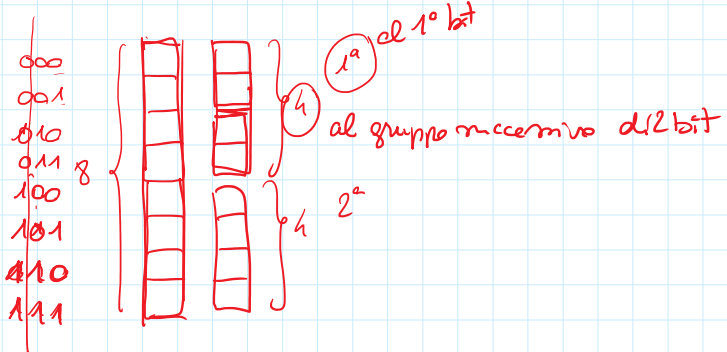
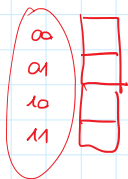
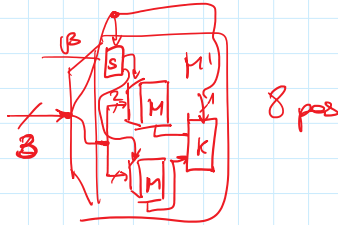
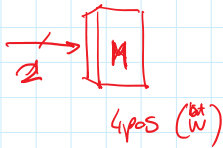
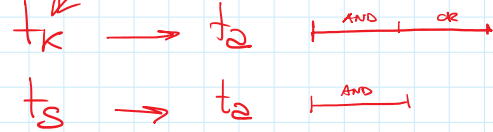

| $d_1 d_2$ | x_1 | x_2 | x_3 | x_4 | Z |
|-----------|-------|-------|-------|-------|---|
| 00 | 1 | - | - | - | 1 |
| 01 | - | 1 | - | - | 1 |
| 10 | - | - | 1 | - | 1 |
| 11 | - | - | - | 1 | 1 |

2^2

| α | x_1 | x_2 | Z |
|----------|-------|-------|---|
| 0 | 1 | - | 1 |
| 1 | - | 1 | 1 |

2^2

| $d_1 d_2 d_3$ | x_1 | x_2 | ... | x_8 | Z |
|---------------|-------|-------|-----|-------|---|
| 000 | 1 | - | - | - | 1 |
| 001 | - | 1 | - | - | 1 |
| 010 | - | - | 1 | - | 1 |

2^3

$11 \text{ --- } 1110$
 2tp
 2tp
 3
 4tp
 +=
 4tp

$2^3 \left\{ \begin{array}{l} 8 \\ "1" \end{array} \right\}$
 $\left. \begin{array}{l} 001 \text{ --- } 1 \text{ --- } 1 \\ 010 \text{ --- } 1 \end{array} \right\} \left| \begin{array}{l} 1 \\ 1 \end{array} \right.$
 2tp
 4 ugreni x AWD

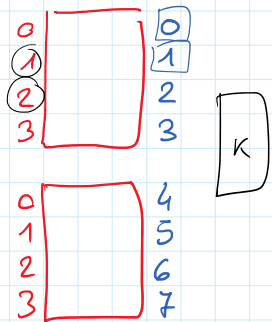
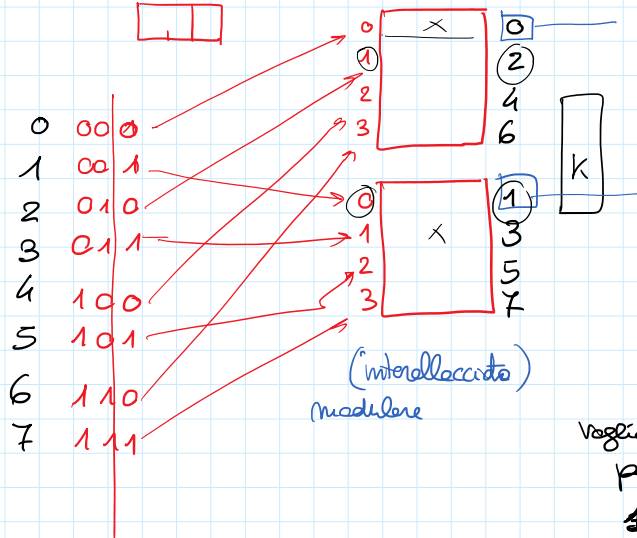
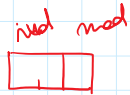
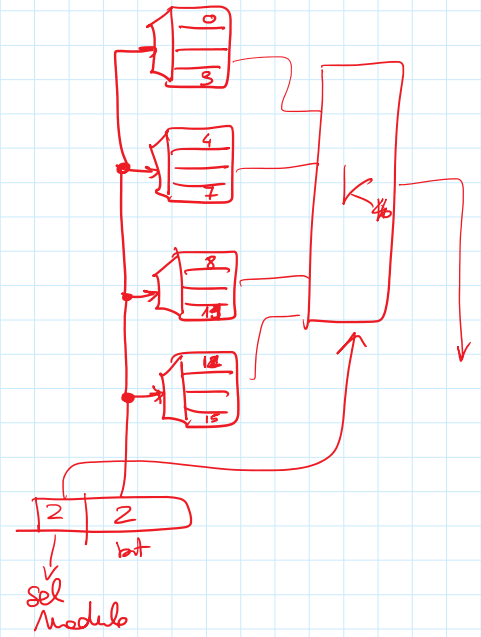
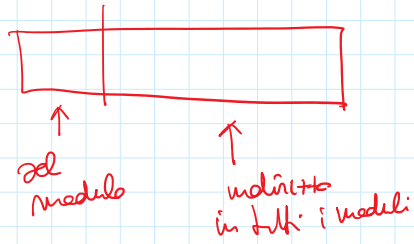
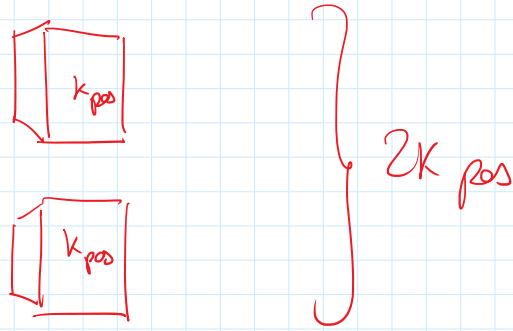

Voglio leggere per 1, 2

0, 1

\uparrow
modulare (sequenziale)

32 bit indirizzato

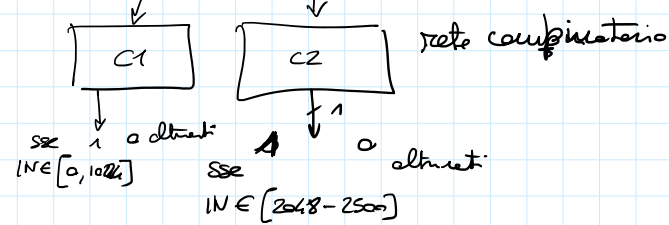
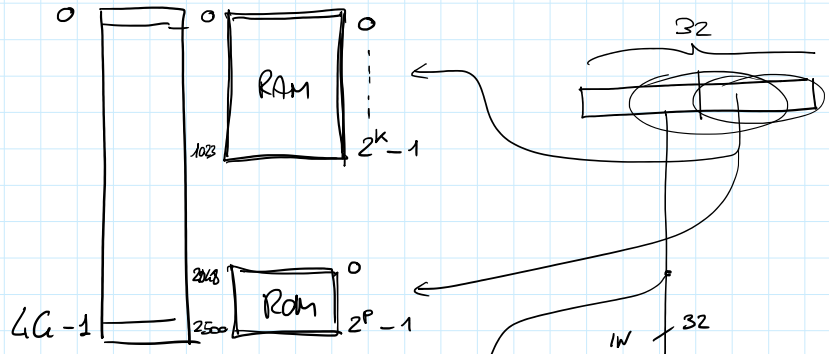
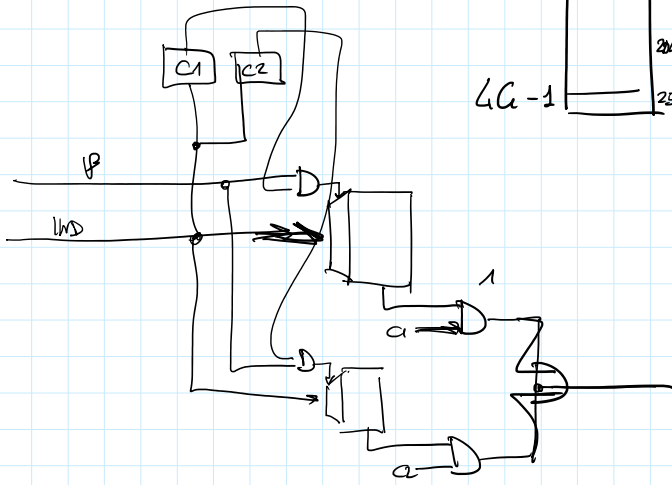

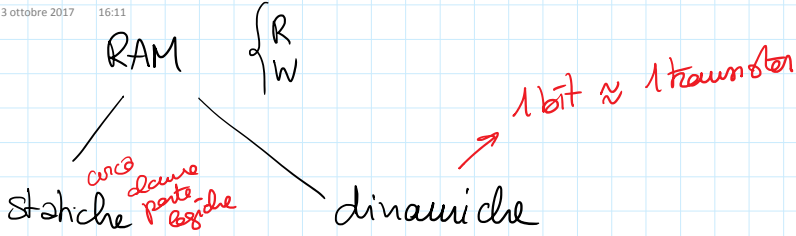

1 bit \approx 1 transistor

area sul chip delle
memorie statiche è dove
velto l'area richiesta
dalle memorie dinamiche

costo statico \rightarrow dinamiche

dopo scrittura
Mantieni il valore
scrittto finché
c'è alimentazione

dopo scrittura
e non legge periodicamente
lo cella di memoria (refresh)
perdo il contenuto

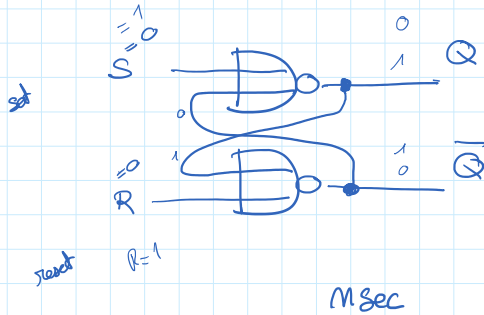

DINAMICA

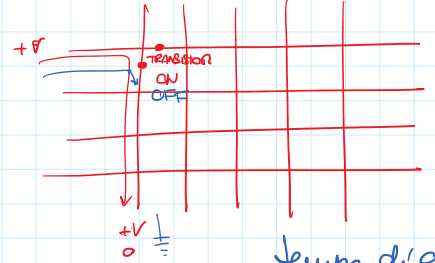

tempo di access
 \gg statiche

$k \cdot O(10) \text{ msec}$

6

martedì 3 ottobre 2017 16:11

7

martedì 3 ottobre 2017 16:11

8

martedì 3 ottobre 2017 16:11

9

martedì 3 ottobre 2017 16:11

10

martedì 3 ottobre 2017 16:11

11

martedì 3 ottobre 2017 16:11

12

martedì 3 ottobre 2017 16:11

13

martedì 3 ottobre 2017 16:11

14

martedì 3 ottobre 2017 16:11

15

martedì 3 ottobre 2017 16:11

16

martedì 3 ottobre 2017 16:11

17

martedì 3 ottobre 2017 16:11

18

martedì 3 ottobre 2017 16:11

20

martedì 3 ottobre 2017 16:11