

PSC 2022/23 (375AA, 9CFU)

Principles for Software Composition

Roberto Bruni

<http://www.di.unipi.it/~bruni/>

[http://didawiki.di.unipi.it/doku.php/
magistraleinformatica/psc/start](http://didawiki.di.unipi.it/doku.php/magistraleinformatica/psc/start)

26 - Probabilistic bisimilarities

From your forms

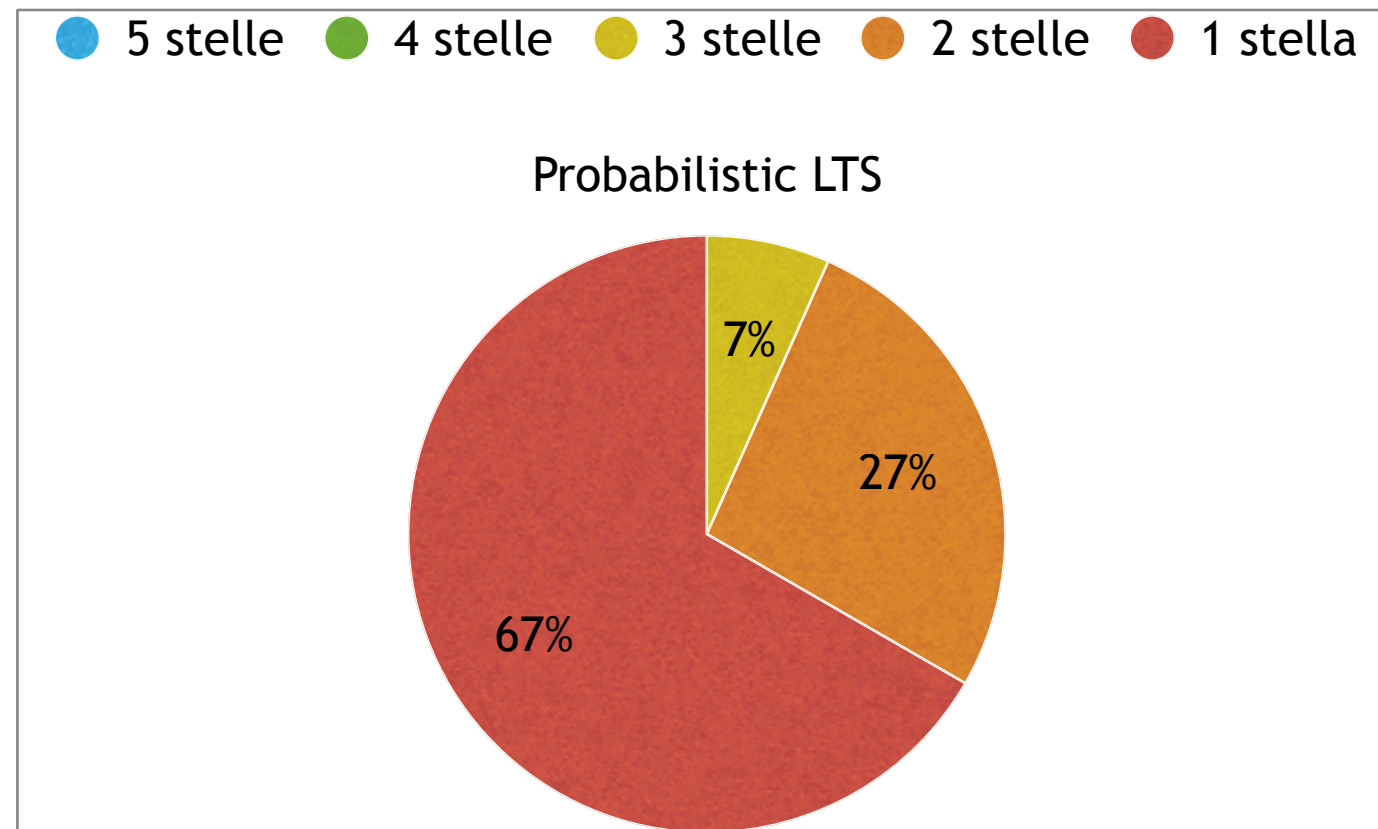

(over 15 answers)

probabilistic bisimilarities

Bisimulation revisited

(S, L, \rightarrow)

labelled transitions
labels
states

alternative presentation of transitions

$$\alpha : S \rightarrow S \rightarrow \wp(L) \quad \alpha p q = \{\mu \mid p \xrightarrow{\mu} q\}$$

generalization to sets of targets

$$\gamma : S \times \wp(S) \rightarrow \wp(L)$$

source
set of targets

$$\gamma(p, I) = \{\mu \mid \exists q \in I. p \xrightarrow{\mu} q\}$$

$$\gamma(p, I) = \bigcup_{q \in I} \alpha p q$$

Bisimulation revisited

$$\alpha : S \rightarrow S \rightarrow \wp(L)$$

$$\gamma : S \times \wp(S) \rightarrow \wp(L)$$

$$\alpha p q = \{\mu \mid p \xrightarrow{\mu} q\}$$

$$\gamma(p, I) = \bigcup_{q \in I} \alpha p q$$

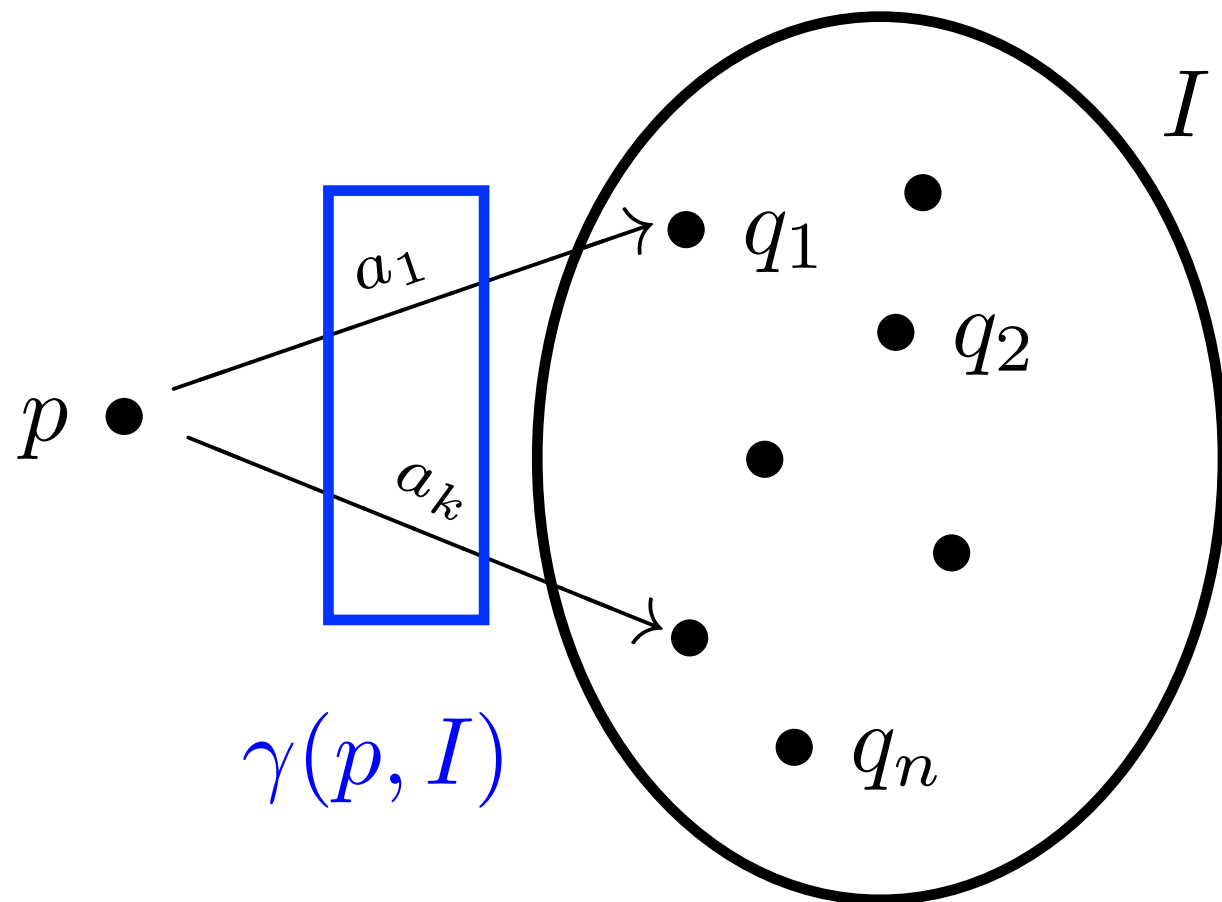

$$p \xrightarrow{\gamma(p, I)} I$$

Bisimulation revisited

$$\alpha p q = \{\mu \mid p \xrightarrow{\mu} q\}$$

$$\gamma(p, I) = \bigcup_{q \in I} \alpha p q$$

take the equivalence $\equiv_{\mathbf{R}}$ induced by a relation \mathbf{R}
(if \mathbf{R} is a bisimulation, then $\equiv_{\mathbf{R}}$ is a bisimulation)

take the set of equivalence classes induced by $\equiv_{\mathbf{R}}$: $S_{|\equiv_{\mathbf{R}}}$

take $J \in S_{|\equiv_{\mathbf{R}}}$ and $p, q \in J$ (i.e., $p \equiv_{\mathbf{R}} q$)

if $p \xrightarrow{\mu} p'$ for some μ, p' then $q \xrightarrow{\mu} q'$ for some q' with $p' \equiv_{\mathbf{R}} q'$
(and vice versa) (i.e. $\exists I \in S_{|\equiv_{\mathbf{R}}} \cdot p', q' \in I$)

now consider the function $\Phi : \wp(S \times S) \rightarrow \wp(S \times S)$

$$p \Phi(\mathbf{R}) q \triangleq \forall I \in S_{|\equiv_{\mathbf{R}}} \cdot \gamma(p, I) = \gamma(q, I)$$

by the above argument, a bisimulation is such if $\mathbf{R} \subseteq \Phi(\mathbf{R})$

$\simeq \triangleq \bigcup_{\mathbf{R} \subseteq \Phi(\mathbf{R})} \mathbf{R}$ is the largest bisimulation

Bisimulation revisited

$$\alpha : S \rightarrow S \rightarrow \wp(L)$$
$$\alpha p q = \{\mu \mid p \xrightarrow{\mu} q\}$$

$$\gamma : S \times \wp(S) \rightarrow \wp(L)$$

$$\gamma(p, I) = \bigcup_{q \in I} \alpha p q$$

$$\Phi : \wp(S \times S) \rightarrow \wp(S \times S)$$

$$p \Phi(\mathbf{R}) q \triangleq \forall I \in S_{\equiv_{\mathbf{R}}} \cdot \gamma(p, I) = \gamma(q, I)$$

bisimulation $\mathbf{R} \subseteq \Phi(\mathbf{R})$

bisimilarity $\simeq \triangleq \bigcup_{\mathbf{R} \subseteq \Phi(\mathbf{R})} \mathbf{R}$

Bisimulation for CTMC

$$\alpha_C: S \rightarrow S \rightarrow \wp(\mathbb{R})$$

$$\alpha(p, q) = i \{ j \mid \mu \neq \lambda_{i,j} \}$$

$$\gamma_C: S \times \wp(S) \rightarrow \wp(\mathbb{R})$$

$$\gamma_C(i, I) = \{ p \mid \sum_{j \in I} \lambda_{i,j} > 0 \}$$

$$\Phi_C: \wp(S \times S) \rightarrow \wp(S \times S)$$

$$i \Phi_C(\mathbb{R}) \ jq \triangleq \forall I \in S_{\neq \mathbb{R}} \cdot \gamma_C(i, I) = \gamma_C(q, I)$$

CTMC bisimulation $\mathbf{R} \subseteq \Phi_C(\mathbb{R})$

CTMC bisimilarity $\approx_C \triangleq \bigcup_{\mathbf{R} \subseteq \Phi_C(\mathbb{R})} \mathbf{R}$

Bisimulation for CTMC

$$\alpha_C : S \rightarrow S \rightarrow \mathbb{R}$$
$$\alpha_C i j = \lambda_{i,j}$$

$$\gamma_C : S \times \wp(S) \rightarrow \mathbb{R}$$
$$\gamma_C(i, I) = \sum_{j \in I} \alpha_C i j = \sum_{j \in I} \lambda_{i,j}$$

$$\Phi_C : \wp(S \times S) \rightarrow \wp(S \times S)$$
$$i \Phi_C(\mathbf{R}) j \triangleq \forall I \in S_{\equiv_{\mathbf{R}}} \cdot \gamma_C(i, I) = \gamma_C(j, I)$$

CTMC bisimulation $\mathbf{R} \subseteq \Phi_C(\mathbf{R})$

CTMC bisimilarity $\simeq_C \triangleq \bigcup_{\mathbf{R} \subseteq \Phi_C(\mathbf{R})} \mathbf{R}$

Bisimulation for CTMC

$$\alpha_C : S \rightarrow S \rightarrow \mathbb{R}$$

$$\alpha_C(i, j) = \lambda_{i,j}$$

$$\gamma_C : S \times \wp(S) \rightarrow \mathbb{R}$$

$$\gamma_C(i, I) = \sum_{j \in I} \alpha_C(i, j) = \sum_{j \in I} \lambda_{i,j}$$

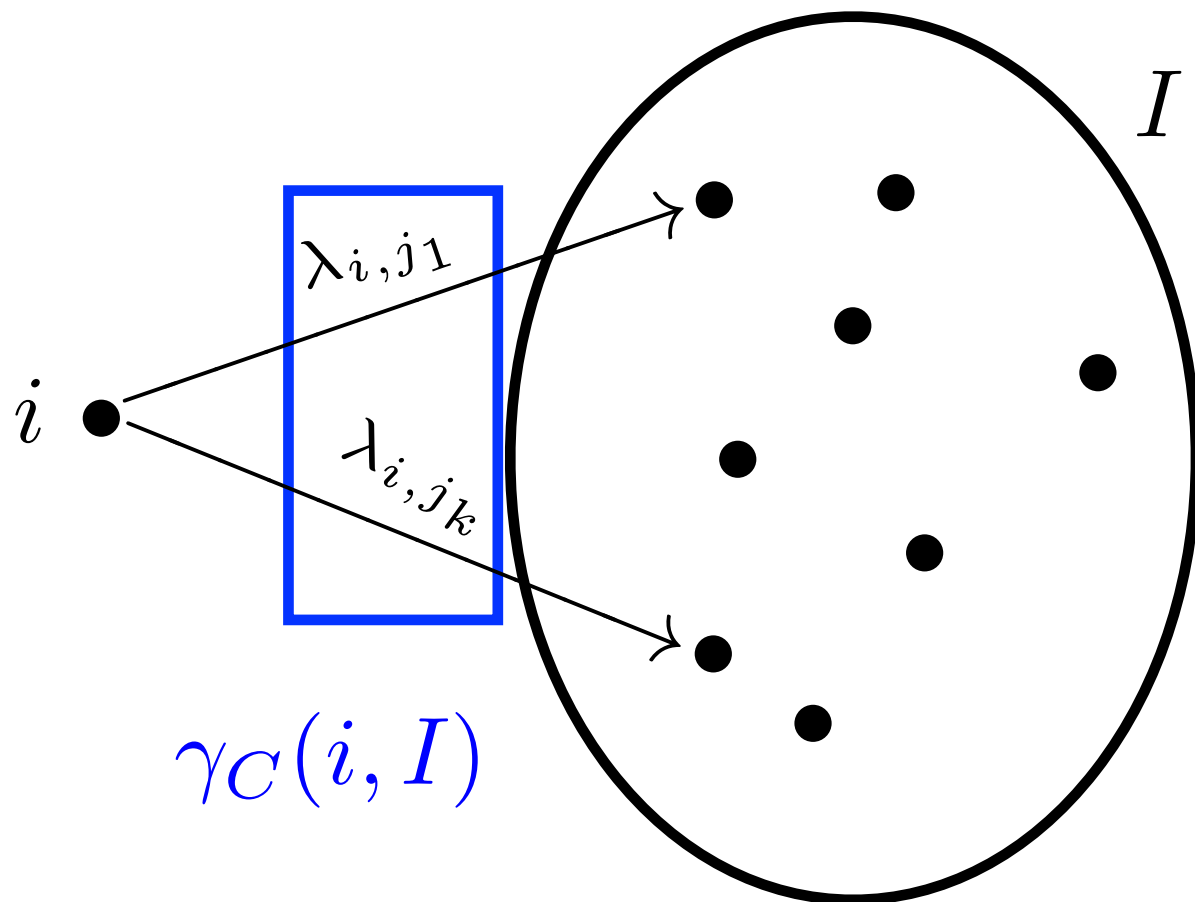

$$i \xrightarrow{\sum_{j \in I} \lambda_{i,j}} I$$

Bisimulation for CTMC

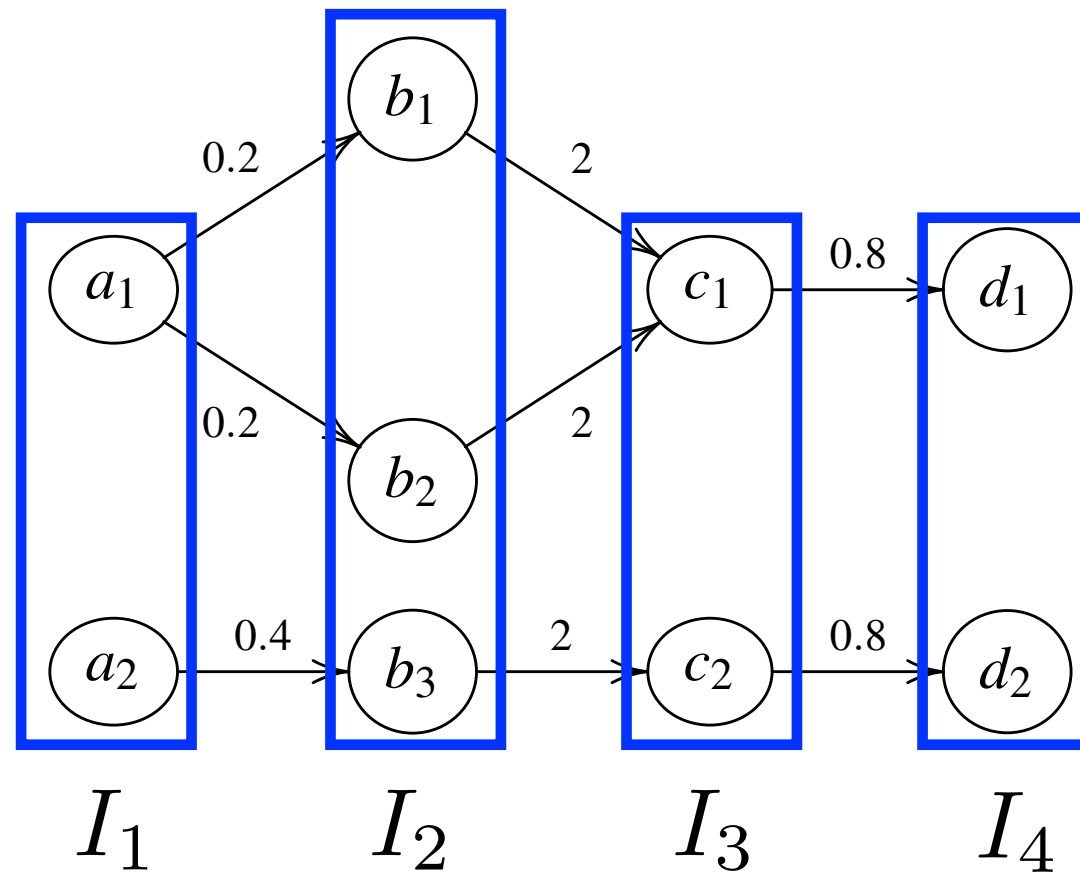

$$\equiv_{\mathbf{R}} = \{ \{a_1, a_2\}, \{b_1, b_2, b_3\}, \{c_1, c_2\}, \{d_1, d_2\} \}$$

$$\forall i. \gamma_C(a_1, I_i) \stackrel{?}{=} \gamma_C(a_2, I_i)$$

$$\gamma_C(b_1, I_i) \stackrel{?}{=} \gamma_C(b_2, I_i) \stackrel{?}{=} \gamma_C(b_3, I_i)$$

$$\gamma_C(c_1, I_i) \stackrel{?}{=} \gamma_C(c_2, I_i)$$

$$\gamma_C(d_1, I_i) \stackrel{?}{=} \gamma_C(d_2, I_i)$$

Bisimulation for DTMC

$$\alpha_D : \mathcal{C}(S) \rightarrow \mathbb{D}(S) \cup \mathbb{R}\{\star\}$$

$$\alpha_D i = d \alpha_C i \quad j = \lambda_{i,j} \quad \alpha_D i = \star$$

$$\gamma_D : \mathcal{C}(S) \times \mathcal{P}(S) \rightarrow [0, 1] \cup \mathbb{R} \cup \{\star\}$$

$$\gamma_D(i, I) = \sum_{j \in I} \alpha_D(i, j) = \sum_{j \in I} \sum_{j \in I} \alpha_C(i, j) = \sum_{j \in I} \lambda_{i,j}$$

$$\Phi_D : \mathcal{P}(S \times S) \rightarrow \mathcal{P}(S \times S)$$

$$i \Phi_D(\mathbf{R}) j \triangleq \forall I \in \mathcal{S}_{\equiv_{\mathbf{R}}} \cdot \gamma_D(i, I) = \gamma_D(j, I)$$

DTMC bisimulation $\mathbf{R} \subseteq \Phi_D(\mathbf{R})$

DTMC bisimilarity $\simeq_D \triangleq \bigcup_{\mathbf{R} \subseteq \Phi_D(\mathbf{R})} \mathbf{R}$

Bisimulation for DTMC

$$\alpha_D : S \rightarrow \mathbb{D}(S) \cup \{\star\}$$

$$\alpha_D i = d \qquad \alpha_D i = \star$$

$$\gamma_D : S \times \wp(S) \rightarrow [0, 1] \cup \{\star\}$$

$$\gamma_D(i, I) = \sum_{j \in I} \alpha_D i j = \sum_{j \in I} a_{i,j} \qquad \gamma_D(i, I) = \star$$

$$\Phi_D : \wp(S \times S) \rightarrow \wp(S \times S)$$

$$i \Phi_D(\mathbf{R}) j \triangleq \forall I \in S_{\equiv \mathbf{R}} \cdot \gamma_D(i, I) = \gamma_D(j, I)$$

DTMC bisimulation $\mathbf{R} \subseteq \Phi_D(\mathbf{R})$

DTMC bisimilarity $\simeq_D \triangleq \bigcup_{\mathbf{R} \subseteq \Phi_D(\mathbf{R})} \mathbf{R}$

Bisimulation for DTMC

any two deadlock states i, j are DTMC bisimilar

$$\forall I. \gamma_D(i, I) = \star = \gamma_D(j, I)$$

any deadlock state i is separated from any non-deadlock state k

$$\exists I. \gamma_D(i, I) = \star \neq \gamma_D(k, I) \in [0, 1]$$

if there are no deadlock states, then $\simeq_D = S \times S$

reactive PTS

DTMC with actions

also called Markov decision processes

Reactive probabilistic transition systems

$$\alpha_R : S \rightarrow L \rightarrow \mathbb{D}(S) \cup \{\star\}$$

source state
label (stimulus)
reaction

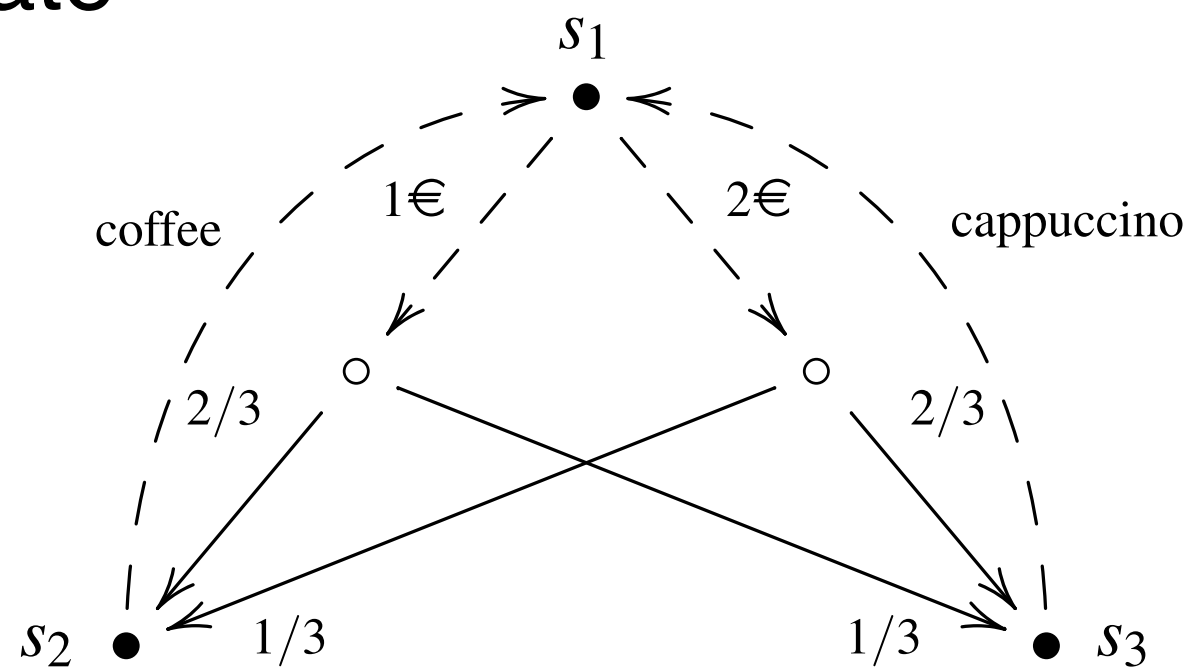
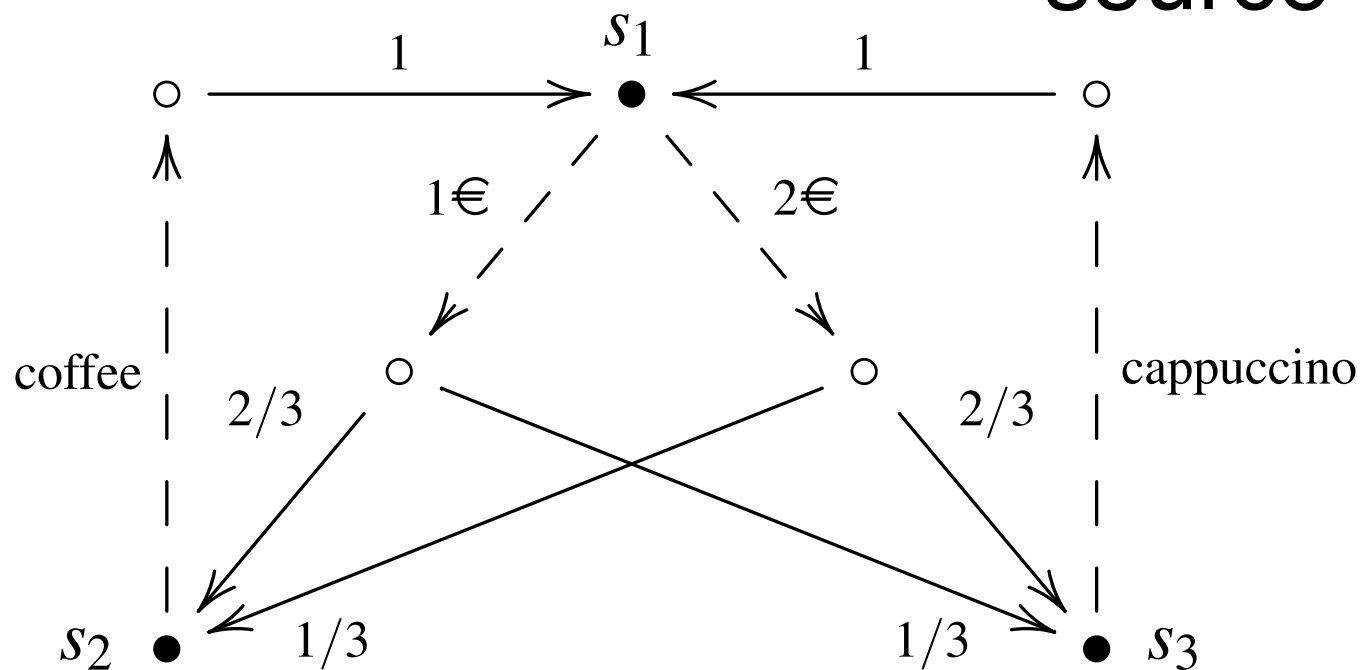

Reactive bisimulation

$$\alpha_R : S \rightarrow L \rightarrow \mathbb{D}(S) \cup \{\star\}$$

$$\alpha_R s \ell = d \qquad \alpha_R s \ell = \star$$

$$\gamma_R : S \times L \times \wp(S) \rightarrow [0, 1]$$

$$\gamma_R(s, \ell, I) = \sum_{u \in I} \alpha_R s \ell u \qquad \gamma_R(s, \ell, I) = 0$$

$$\Phi_R : \wp(S \times S) \rightarrow \wp(S \times S)$$

$$s \Phi_R(\mathbf{R}) u \triangleq \forall \ell \in L. \forall I \in S_{\equiv_{\mathbf{R}}} \cdot \gamma_R(s, \ell, I) = \gamma_R(u, \ell, I)$$

reactive bisimulation $\mathbf{R} \subseteq \Phi_R(\mathbf{R})$

reactive bisimilarity $\simeq_R \triangleq \bigcup_{\mathbf{R} \subseteq \Phi_R(\mathbf{R})} \mathbf{R}$

Larsen-Skou logic: syntax

| | | | |
|-----------|-------|-------------------------------|------------------|
| φ | $::=$ | tt | true |
| | | $\varphi_1 \wedge \varphi_2$ | conjunction |
| | | $\neg\varphi$ | negation |
| | | $\langle l \rangle_q \varphi$ | diamond operator |
| | | | probability |
| | | | label |

Larsen-Skou: semantics

$$s \models \varphi$$

defined inductively on the structure of the formula

$s \models \mathbf{tt}$ any state satisfies true

$s \models \varphi_1 \wedge \varphi_2$ iff $s \models \varphi_1$ and $s \models \varphi_2$ s satisfies both φ_1 and φ_2

$s \models \neg\varphi$ iff $s \not\models \varphi$ s does not satisfy φ

$s \models \langle l \rangle_q \varphi$ iff $\gamma_R(s, l, \llbracket \varphi \rrbracket) \geq q$ the sum of all probabilities to reach a state u that satisfies φ is greater than or equal to q

where $\llbracket \varphi \rrbracket \triangleq \{u \in S \mid u \models \varphi\}$

$\diamond_l \varphi$ is just $\langle l \rangle_1 \varphi$

Example

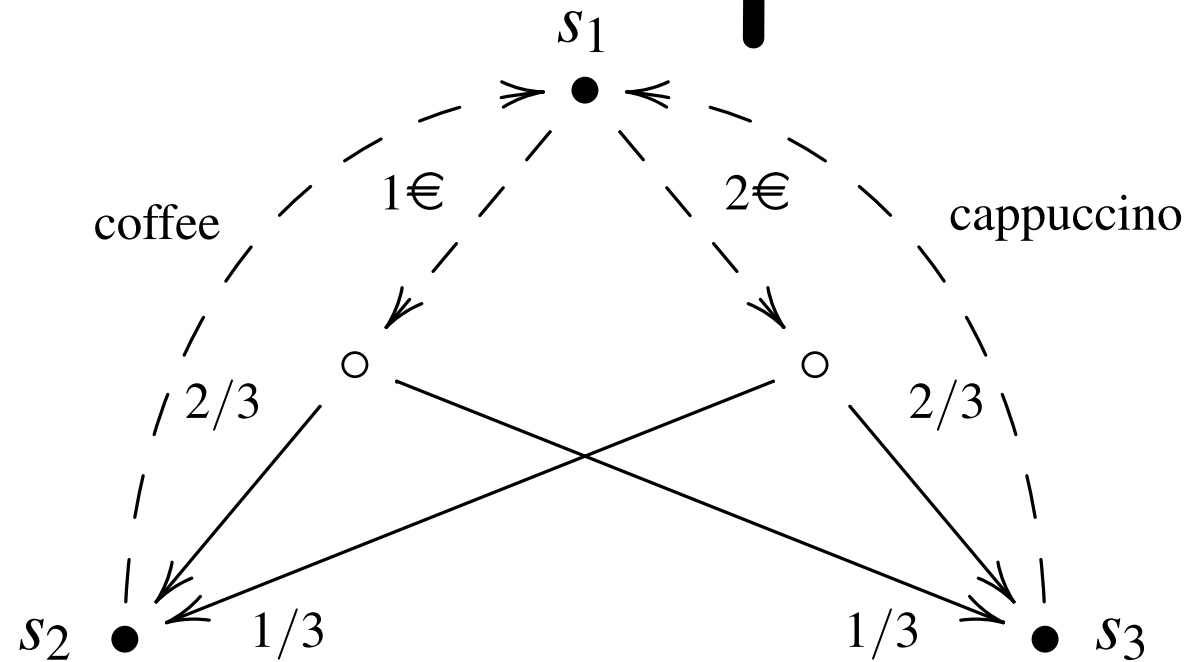

$$s_1 \stackrel{?}{\models} \langle 1\text{€} \rangle_{\frac{1}{2}} \langle \text{coffee} \rangle_1 \mathbf{tt} \quad \gamma_R(s_1, 1\text{€}, \llbracket \langle \text{coffee} \rangle_1 \mathbf{tt} \rrbracket) \stackrel{?}{\geq} \frac{1}{2}$$

$$\begin{aligned} \llbracket \langle \text{coffee} \rangle_1 \mathbf{tt} \rrbracket &= \{u \mid u \models \langle \text{coffee} \rangle_1 \mathbf{tt}\} \\ &= \{u \mid \gamma_R(u, \text{coffee}, \llbracket \mathbf{tt} \rrbracket) \geq 1\} \\ &= \{u \mid \gamma_R(u, \text{coffee}, S) \geq 1\} \\ &= \{s_2\} \end{aligned}$$

$$\gamma_R(s_1, 1\text{€}, \{s_2\}) = \frac{2}{3} \geq \frac{1}{2}$$

Reactive bis as logic

TH. $s_1 \simeq_R s_2$ iff $\forall \varphi. s_1 \models \varphi \Leftrightarrow s_2 \models \varphi$

it is even sufficient to consider formulas without negation!

Logical characterisation of reactive bisimilarity

consequences:

to show that two reactive PTS are reactive bisimilar:
exhibit a reactive bisimulation that relates them

to show that two reactive PTS are not reactive bisimilar:
exhibit a LS formula that distinguishes between them