

Business Processes Modelling

MPB (6 cfu, 295AA)

Roberto Bruni

<http://www.di.unipi.it/~bruni>

02 - Business processes



Digression...

Theorem

A (connected) graph G contains an **Eulerian circuit** if and only if there are no odd vertices.

Theorem

A (connected) graph contains an **Eulerian path** if and only if there are 0 or 2 odd vertices.

Digression...

Eu path
no Eu circuit

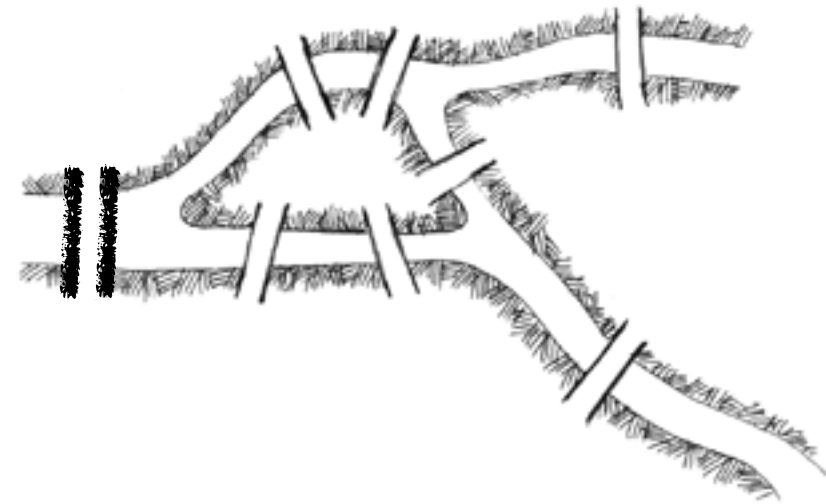
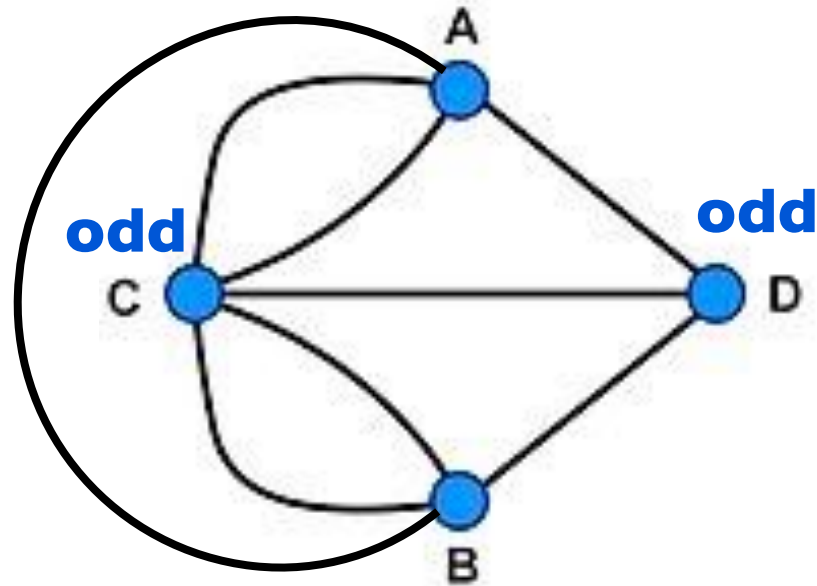

Eu path
no Eu circuit

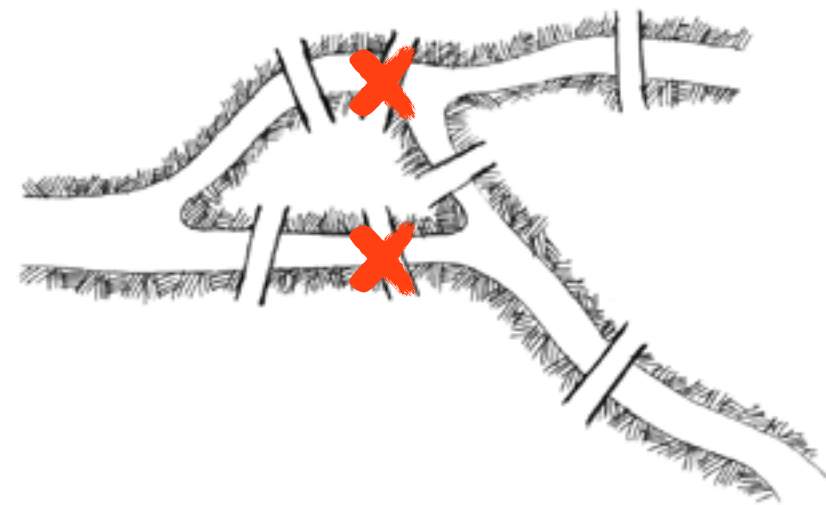
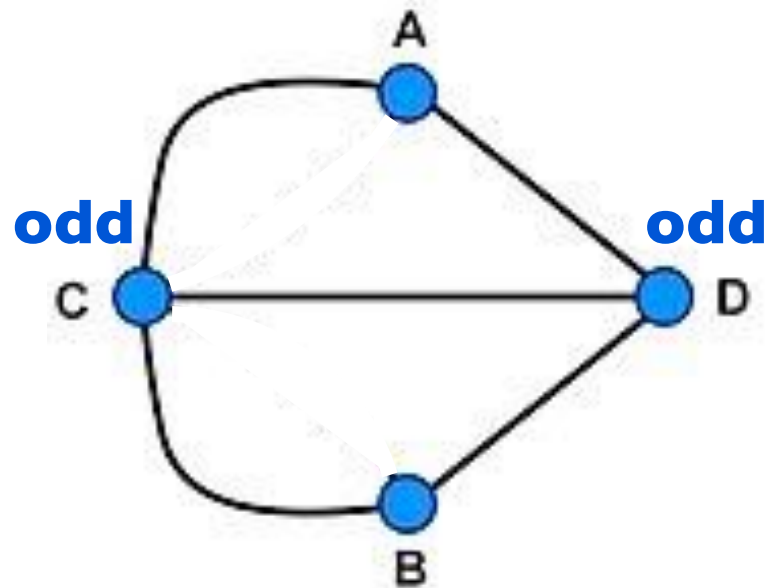

Digression...

Eu path
no Eu circuit

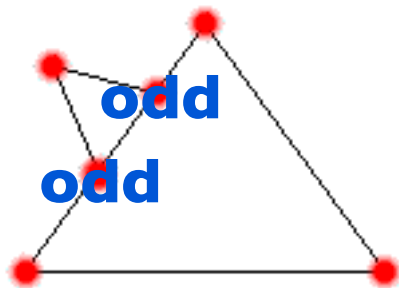

no Eu path
no Eu circuit

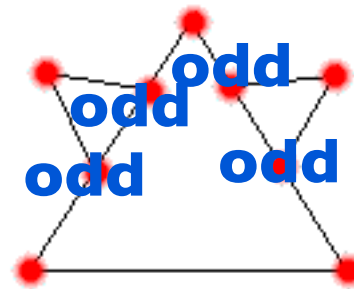

Eu path
no Eu circuit

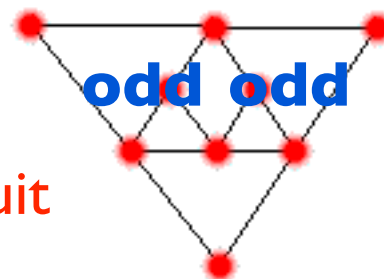

no Eu path
no Eu circuit

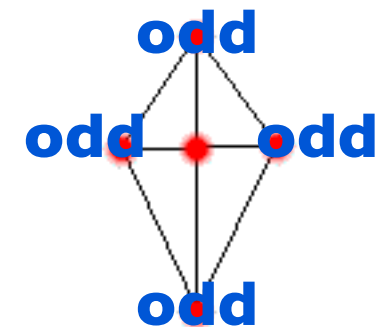

Exercises: find Eulerian path/circuits in the graphs above or prove that they cannot exist.

Digression...

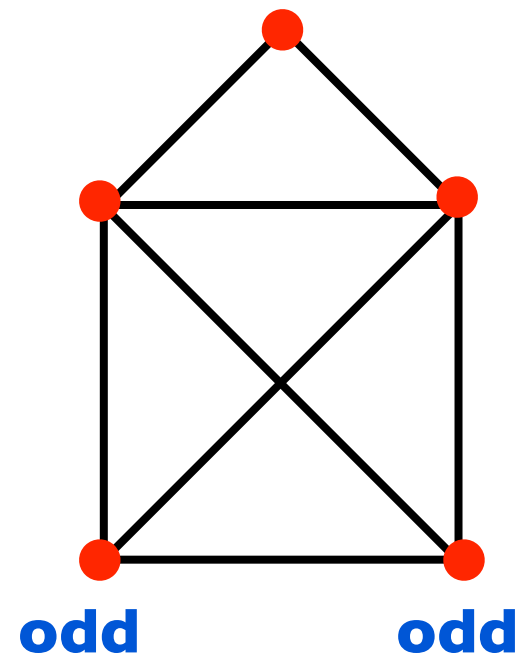

Eu path

no Eu circuit

A childish puzzle

Digression...

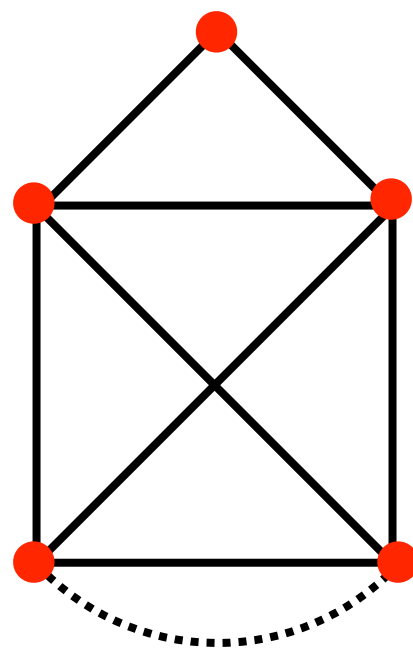

A childish puzzle

Digression...

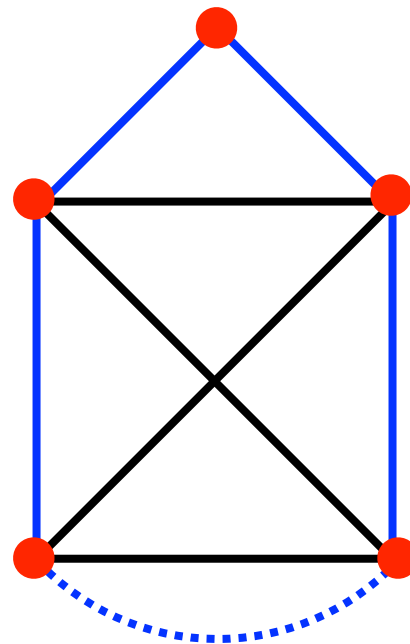

A childish puzzle

Digression...

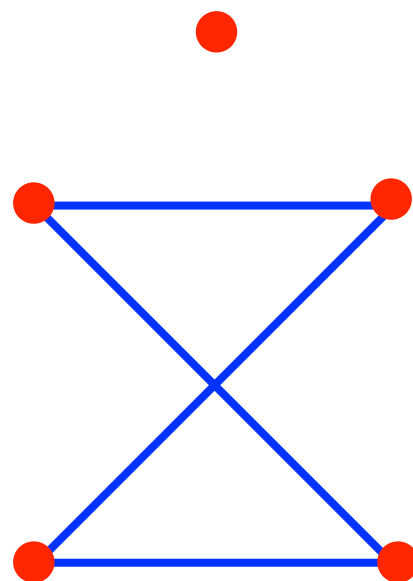

A childish puzzle

Digression...

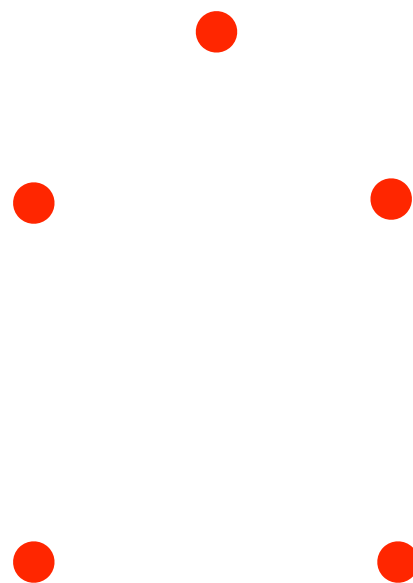

A childish puzzle

Digression...

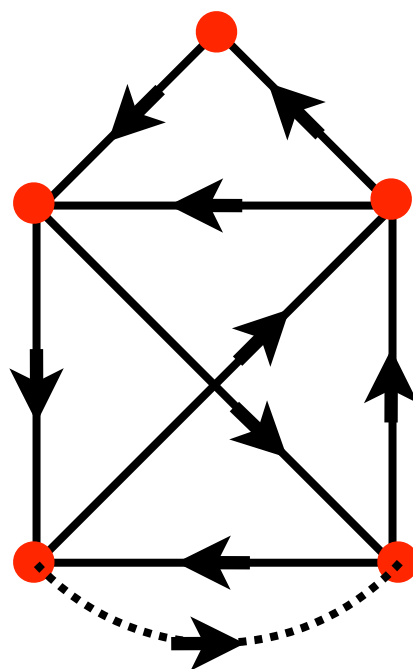

A childish puzzle

Who are you?

First Name:

Last Name:

Enrollment number:

email:

Bachelor degree:

MSc course of enrollment:

Subjects of interest:

Please, send your data to bruni@di.unipi.it

with object "MPB"

Terminology

Generic terms, widely applicable to different working situations and companies

We fix preferred terms when possible, but allow synonyms interchangeably

Ch.1 of Workflow Management: Models, Methods, and Systems

Ch.1 of Business Process Management: Concepts, Languages, Architectures

Issues

- Process Orientation**
- Organizational structures
- Principal-contractor relationship
- Cases and procedures
- Process management
- Some definitions

Work

People work to live
(or do we live to work?)

We need **products** to live our lives
(food, clothing, house, transportation, fun, health)

Products are the outcome of some **work**

Market

We are not capable to produce all we need
(or all we want, or that we are induced to want)
because we cannot be skilled enough

We buy products we cannot make ourselves

Products are supplied to people via markets
(distribution in exchange of money)

New services

Other work emerge, that would not exist
(trading, banks, advertising, transportation,
regulations, attorneys, insurance companies,
eCommerce, influencers)

There are **services** and **products** necessary to
keep the organization operating
(not making a direct contribution to keep us alive)

Business units

People organize specialized business units

They know how to do some specific product
(limited range of products, highly efficient)

Taylorism

Process orientation is based on a critical analysis of a concept to organize work units originally introduced by Frederick Taylor (1856-1915) to improve industrial efficiency

Taylorism uses functional breakdown of complex work to small granularities

Then, highly specialized work force can efficiently conduct these work units of small granularity

Taylorism has proved very successful in manufacturing and fuelled the industrial revolution

Taylorism

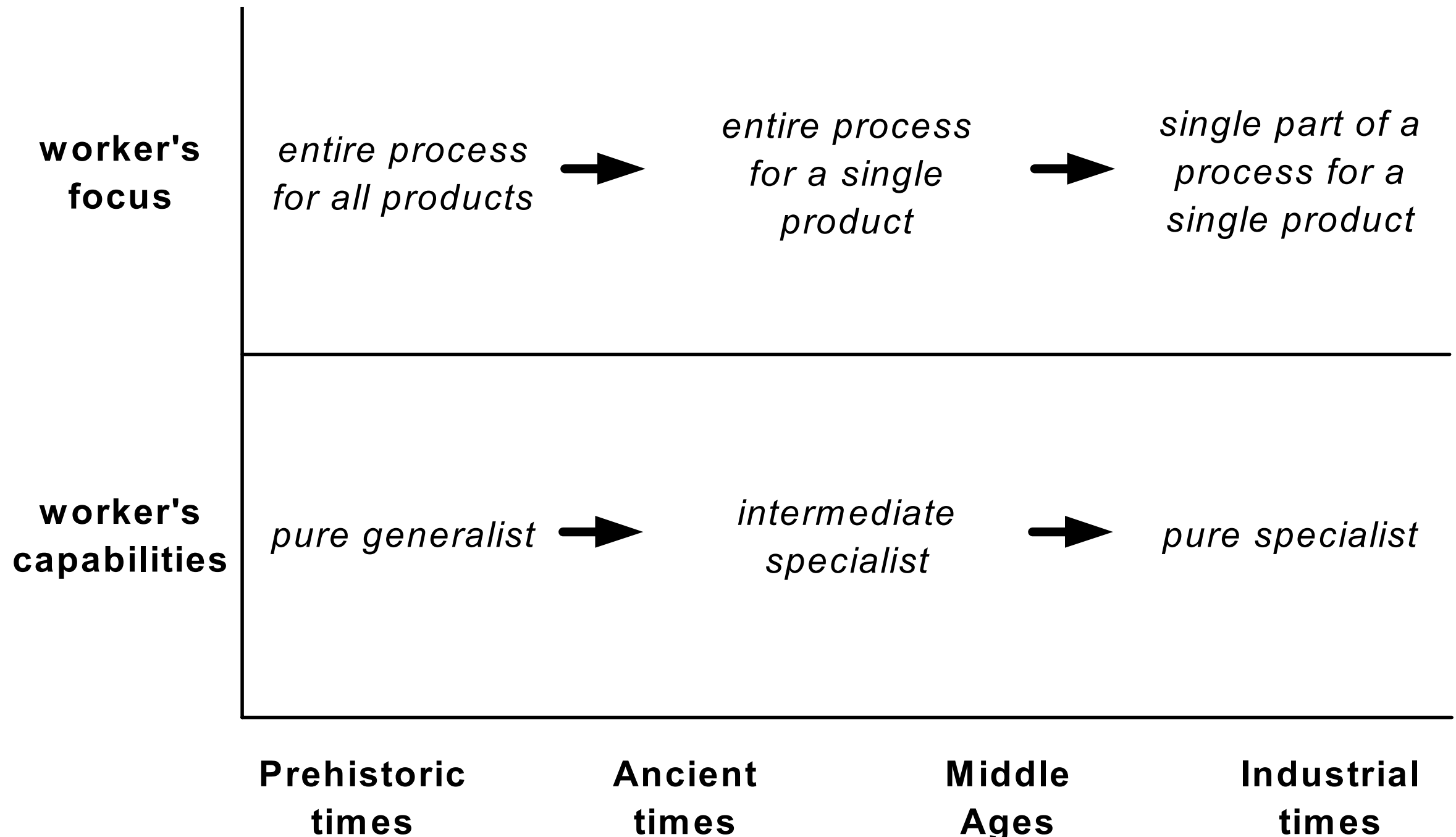

Handovers

Fine-grained activities require many handovers of work in order to process a given task

Until early nineteenth century the products were typically assembled in a few steps only, so handovers were not introducing much delays

Moreover, tasks were of simple nature and did not require any context information on previously conducted steps

Taylorism proved inefficient for organizing work in modern enterprises

Pitfall of Taylorism

Steps of a business process are often related to each other

Context information on the whole case is required during the process

The handovers of work cause a major problem because of that (workers required knowledge)

In the end, functional breakdown proved inefficient in modern business organizations that mainly process information

Complexity

Modern society is too complex for people to see how their work fits in the overall scheme
(alienation can become a major social problem)

The same scheme applies to large companies:
high degree of work specialization
cause big picture be lost by employees
(why do they have to do the things they are told to do?)

Process Orientation

Alienation from work can have negative effects on
(human life and) productivity

Companies can allow employees to know
they are working for a particular customer
(increase motivation, self-esteem, productivity)

Not only process orientation serves
to capture the activities a company performs, but also
to **study** and **improve** the **relationships** between activities

Process perspective

It is instrumental to combine multiple units of work of small granularity into work units of larger granularity to reduce the handover of work

As a consequence, workers must have broader skills and competencies

(knowledge workers must have a broad understanding of the ultimate goal of their work)

Main effect, at the organizational level, process orientation led to the characterization of high-level operations (usually, less than a dozen), called **organizational business processes**

Issues

- Process Orientation
- Organizational structures**
- Principal-contractor relationship
- Cases and procedures
- Process management
- Some definitions

Organizational structure

An **organizational structure** establishes how the work, authorities and responsibilities are divided up amongst its staff
(**roles and functions**)

A single person can fulfill several roles, at the same time or at different times

How to reduce bureaucracy



Most relevant forms of organizational structure

Hierarchical:

structured as a tree,
internal nodes are individual roles or functions,
leaves are staff or departments,
branches are authority relationships
(independent of cases)

Hierarchical structure

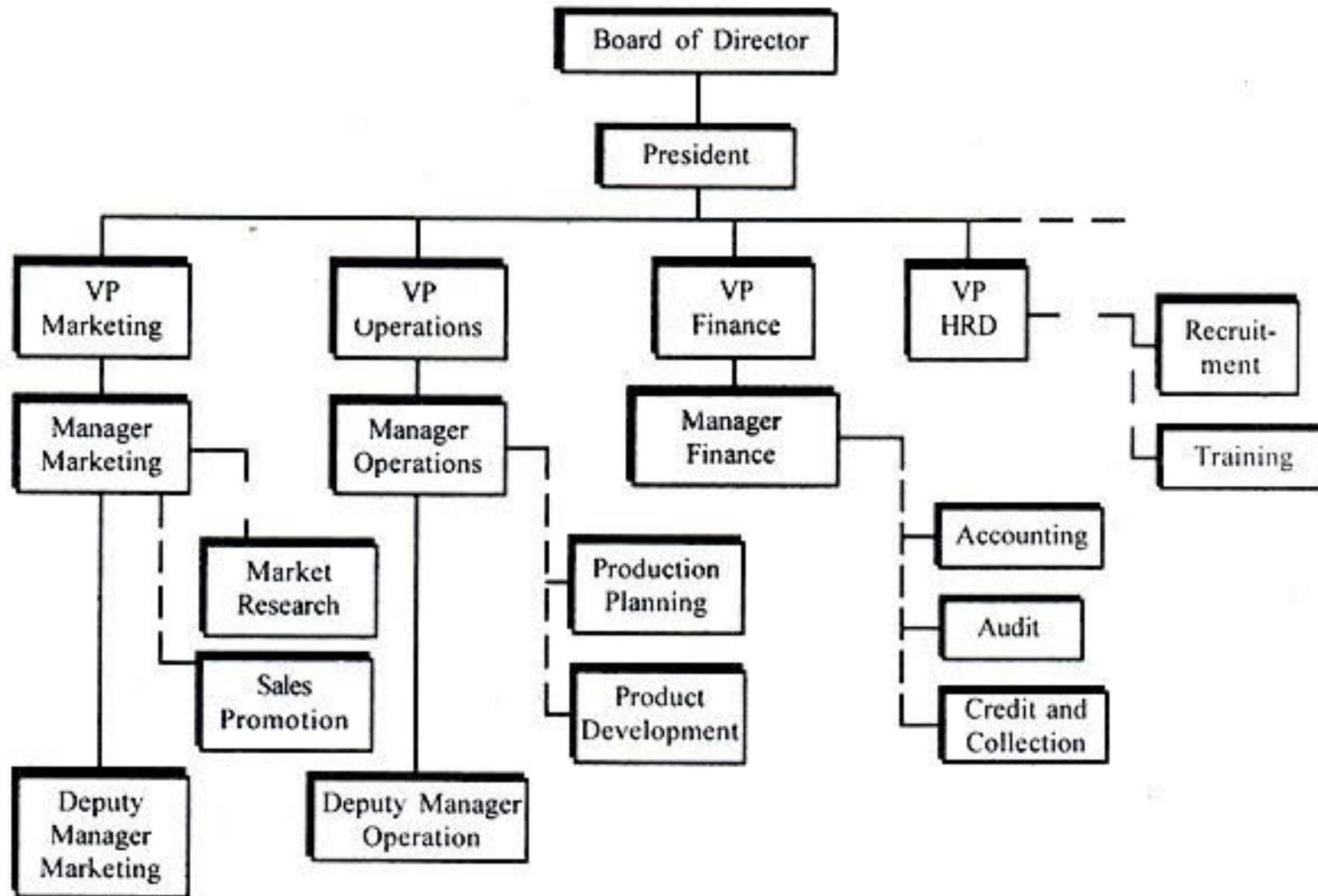

Legend : — Line Authority

-- Staff Relationship

Most relevant forms of organizational structure

Matrix:

add (dynamic) functional dimension
(each person can have one or more functional bosses, known as project leaders)

Matrix structure

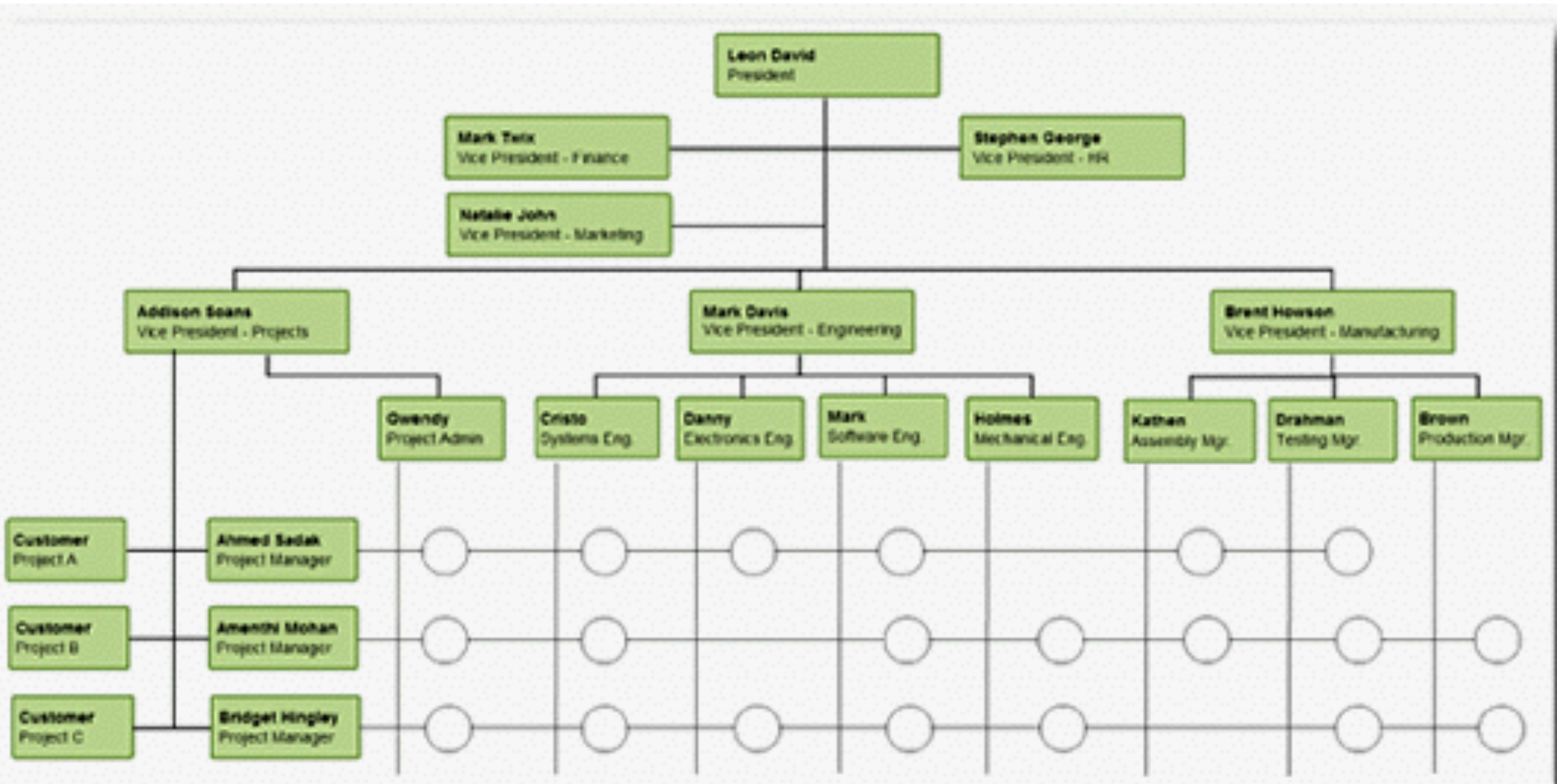

Most relevant forms of organizational structure

Network:

autonomous actors collaborate
to supply products or services

Network structure

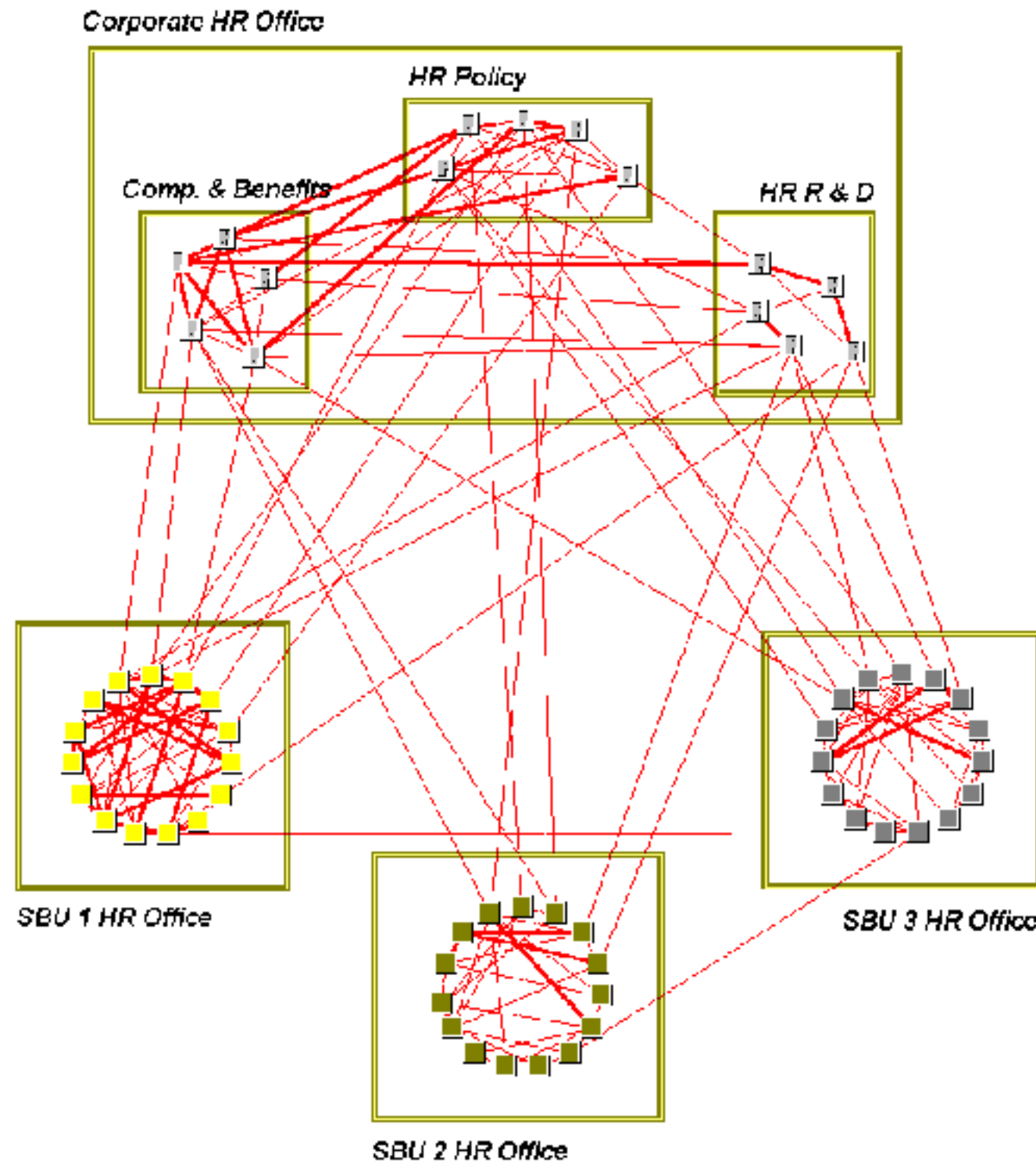

Issues

- Process Orientation
- Organizational structures
- Principal-contractor relationship**
- Cases and procedures
- Process management
- Some definitions

Principal

Most people's work is assigned or outsourced to them by other people: their **principals** (they can be company departments or firms)

We can divide principals in two forms:
boss and **customer**

Assignments ordered by bosses are often related to work for customers

Contractors

A person who is assigned a task is called **contractor**, or also **resource**
(assignments can be carried out by machines and computer applications as well as people)

Actors

An **actor** can be a principal or a contractor, or
play both roles at the same time
(contractors may redirect work to third parties)

Contract

A **contract** exists between a principal and a contractor about the case to be performed (deadline for completion, price to be paid)

A **communication** protocol can be established between a principal and a contractor to exchange information

Protocol example

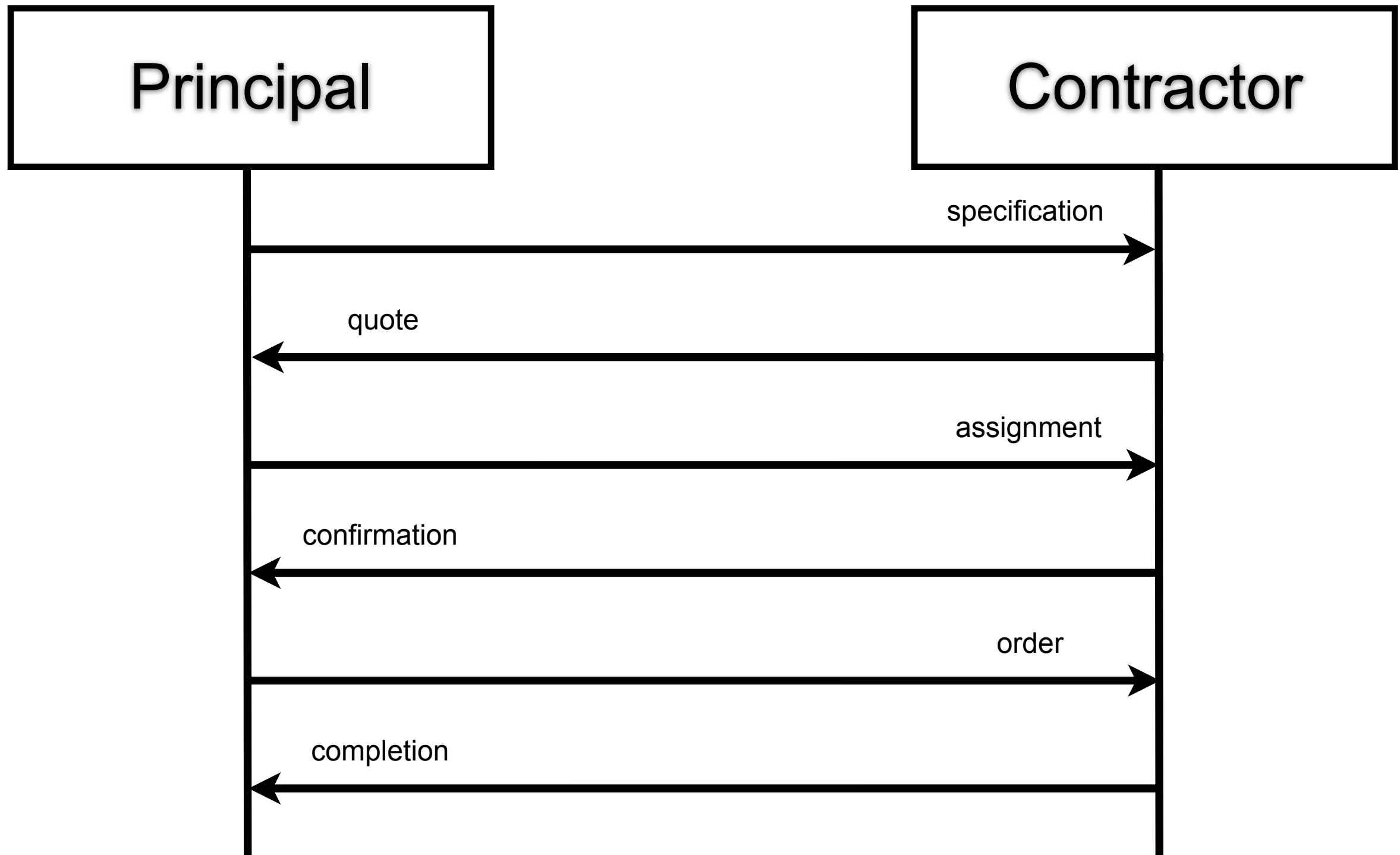

Contract tree example

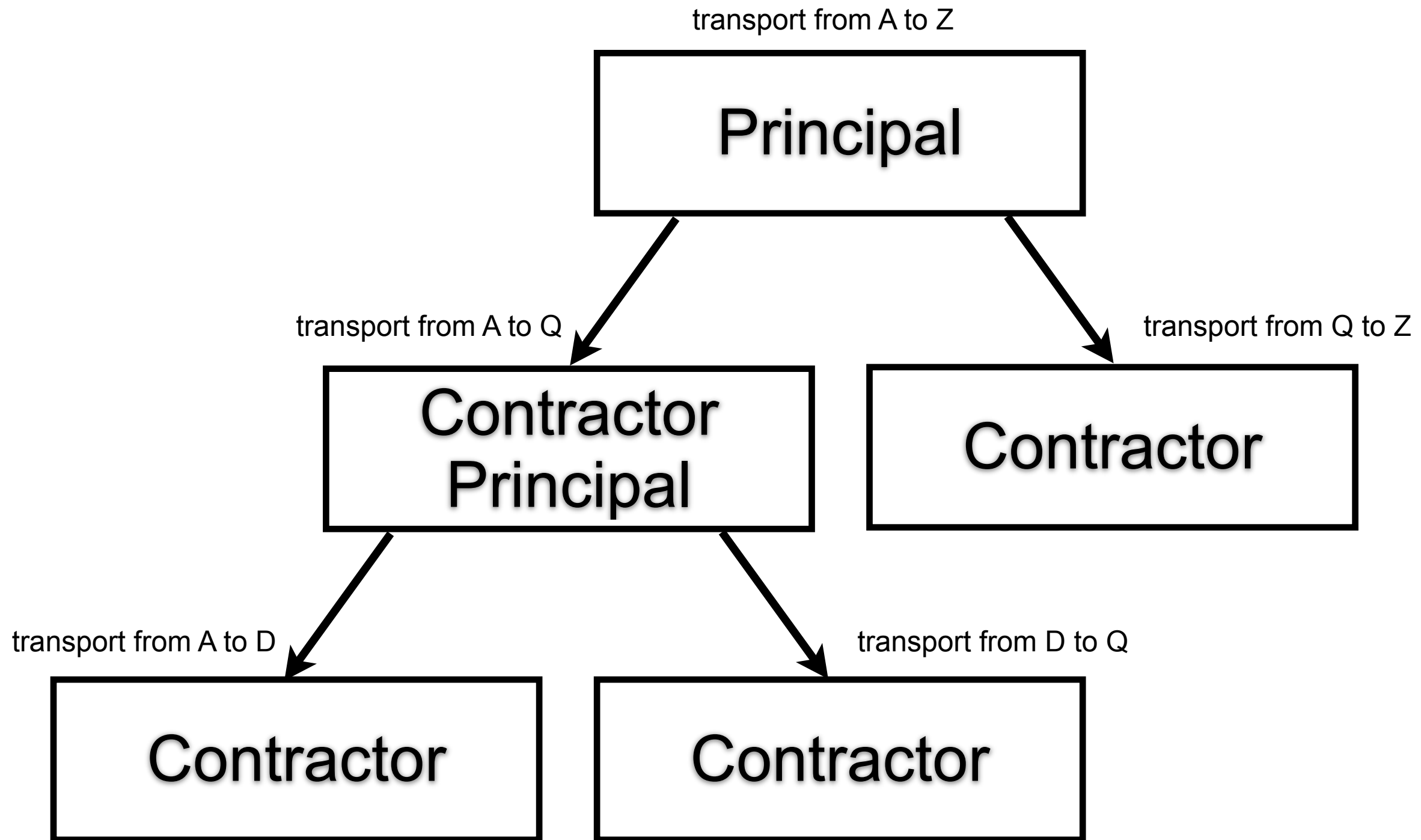

Issues

- Process Orientation
- Organizational structures
- Principal-contractor relationship
- Cases and procedures**
- Process management
- Some definitions

Case

Many different types of work exist
(baking bread, making furniture, design a building,
collect surveys to compile a statistic)

They have in common the **case**:
one tangible thing produced or modified
(bread, furniture, house, diagram)
but more abstract cases are also possible
(a lawsuit, an insurance claim, digital data)

Synonyms: work, job, product, service, item

Procedure

Working on a case is typically discrete in nature

Every case has a beginning and an end

Each case can be distinguished from any other case

Each case involves a **procedure** being performed:
the tasks to be carried out and the conditions that
determine the order of the tasks

Synonyms: process, project

Task

A **task** is a logical unit of work that is carried out as a single whole

Example: Make a Pizza

1. Check ingredients
2. Check tools
3. Make the dough balls
4. Prepare toppings (while dough rises)
5. Shape dough balls into pizza
6. Top it
7. Cook it

Tasks?
Procedures?
Cases?



Knowledge

Some tasks can be performed by a computer without human intervention

Executing some tasks may require human intelligence: a judgement or a decision
(a bank employee decides about a loan request)

Persons need **knowledge** to execute tasks
(their past experience, company guidelines)

Resource

A **resource** is the generic name for a person, machine or group of persons or machines that is responsible for a task

Activity

An **activity** is
the performance of a task by a resource

Various cases may share the same procedure, but each case may involve different activities to be carried out, depending on case **attributes** (one insurance claim may involve objections and another one may not)

Example: Make a Pizza

1. Check ingredients
2. Check tools
3. Make the dough balls
4. Prepare toppings (while dough rises)
5. Shape dough balls into pizza
6. Top it
7. Cook it

Knowledge?
Resources?
Activities?



Example: Make a Pizza

Knowing the procedure is essential, but

Not all recipes are the same

Not all pizzas taste the same

Execution is important

Training is important



Cases vs procedures

The number of procedures in a company is (generally) finite and far smaller than the number of cases to be handled

Example

it is easier to make
one hundred skirts with the same pattern
than one hundred skirts using different patterns

(off-the-rack is cheaper
than made-to-measure)

Economy of scale

The cost per case falls
as the number of cases increases

Strategy: keep the number of procedures small and
make the number of cases that each can perform as
high as possible

Example

Insurance companies want to keep the number of claims as low as possible, but this is generally a factor they cannot control

They can try to **keep low the number of procedures**, but the risk is to make them too much complex (a unique procedure to handle all cases is possible in principle, but inefficient in practice)

Ideal situation:

a small number of good procedures, with a lot of cases to be handled by each of them

Counter-examples?

What about tailor-made suits?
one case per process?

What about architects and houses?
each case designed from scratch?

Not so different?

Tailors and architects can exploit standard approaches for each case

Tailor process:
take customer's measurement,
show a number of patterns,
modify the chosen pattern,
choose the fabric,
draw the pattern

Observation:
task execution can be highly dependent on cases

Issues

- Process Orientation
- Organizational structures
- Principal-contractor relationship
- Cases and procedures
- Process management**
- Some definitions

What is all about

Each **product** that a company provides to the market is the outcome of a number of **tasks** performed

Business processes are about activities **understanding, correlation, organization and improvement**

Awareness

Process management systems
support and encourage
communication between employees
and make their activities more controllable

Business process reengineering is based on the
understanding that **rapid, radical redesign of**
business processes is the road to success

Process orientation roots (1990's)

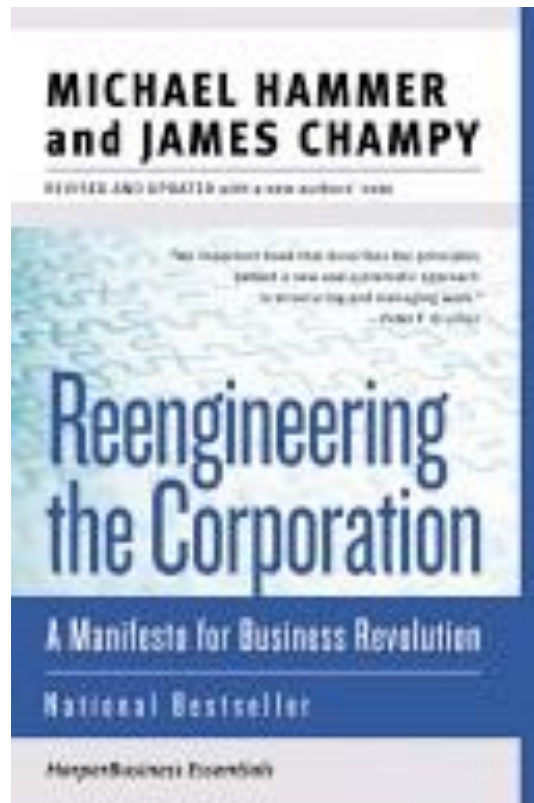

Seminal book advocating the radical redesign of the business process of a company (as opposed to evolutionary improvements)

A **business process** is a **collection of activities** that take one or more kinds of **input** and create an **output** that is of value to the customer

- Hammer & Champy (1993)

How vs What

The main innovation is the shift of focus on the business logic of the process (**how work is done**), instead of the product perspective (**what is done**)

Keywords

Hammer & Champy: **collection, input, output**

Process orientation roots (1990's)

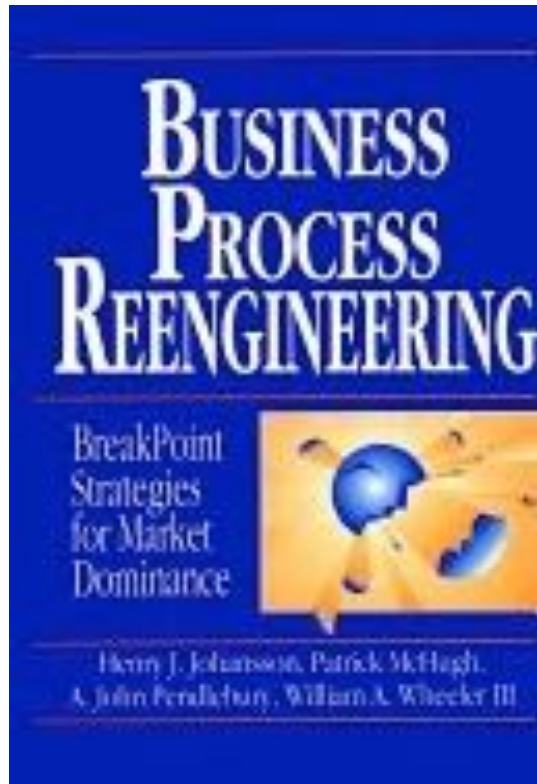

The transformation that occurs in the process should add value to the input and create an output that is more useful and effective to the **recipient**

A process is a set of **linked** activities that take an input and transform it to create an output.

- *Johansson et al. (1993)*

Keywords

Hammer & Champy: **collection, input, output**

Johansson et al.: **recipient, linked**

Process orientation roots (1990's)

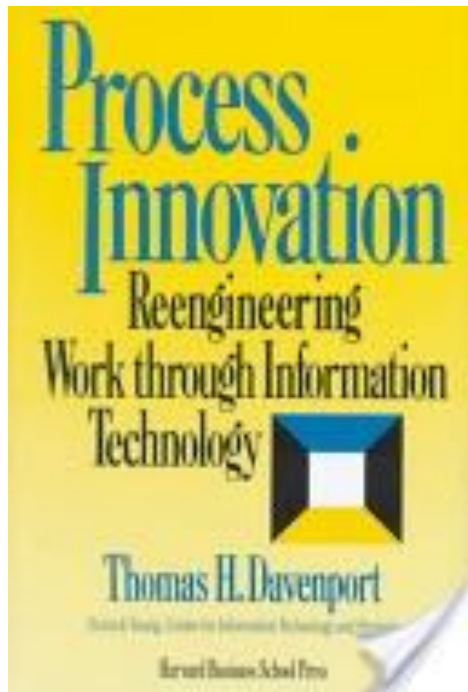

Processes as **structured** sets of activities designed to produce a specific output for a particular market

A **process** is a specific **ordering** of work activities across **time** and **space**, with a **beginning** and an **end**.

- *Davenport (1993)*

More from Davenport

Unless designers or participants can agree on the way work is and should be **structured**, it will be very difficult to systematically improve, or effect innovation in, that work

Following a structured process is generally a good thing, and there is nothing inherently slow or inefficient about acting along process lines

Keywords

Hammer & Champy: **collection, input, output**

Johansson et al.: **recipient, linked**

Davenport: **structure, ordering, time, space, begin, end**

More from Davenport

Processes that are clearly structured are amenable to **measurement** in a variety of dimensions have cost, time, output quality, and customer satisfaction

When we reduce cost or increase customer satisfaction, we have bettered the process itself

More from Davenport

Processes also need clearly defined **owners** to be responsible for design and execution.

Ownership must be seen as an additional or alternative dimension of the organizational structure.

During periods of radical process change, ownership **takes precedence** over other organizational structures. Otherwise process owners will not have the power or legitimacy needed to implement process designs that violate organizational charts and norms

Keywords

Hammer & Champy: **collection, input, output**

Johansson et al.: **recipient, linked**

Davenport: **structure, ordering, time, space, begin, end, measurement, ownership**

Process orientation roots (1990's)

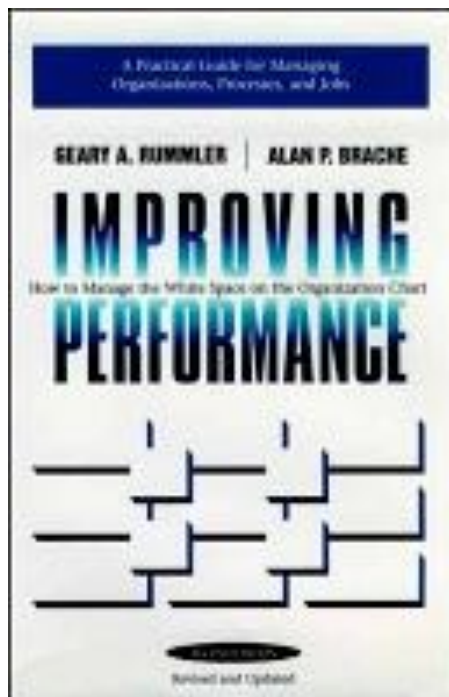

Some processes result in a product or service that is received by an organization's external customer. We call these **production** processes.

Other processes produce products that are invisible to the external customer but essential to the effective management of the business.

- Rummler & Brache (1995)

Primary process

Produce company's products
(**production** processes)

Customer-oriented, even if sometimes the customer is not known in advance

Generate income for the company

Examples: raw materials purchase, service sale, design and engineering, distribution

Secondary process

Support primary processes
(**support** processes)

Examples: machinery purchase and maintenance, personnel management (recruitment and selection, training, work appraisal, payrolls, dismissal), financial administration, marketing

Tertiary process

Direct and coordinate primary and secondary ones
(**managerial** processes)

Fix objectives, allocated resources and
preconditions for the managers of other processes

Examples: maintenance of contracts with
financiers and other stakeholders

1, 2, 3

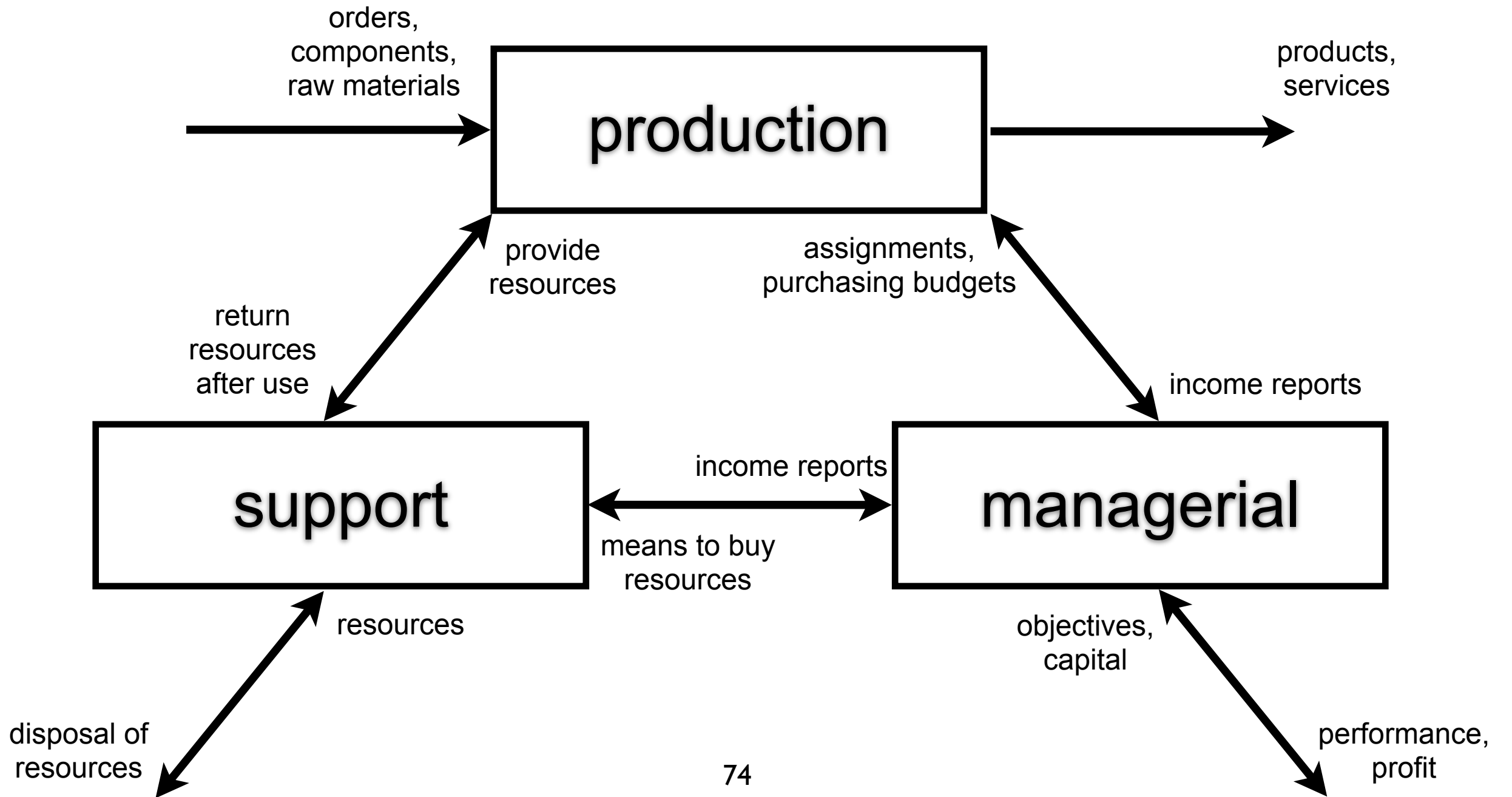

Keywords

Hammer & Champy: **collection, input, output**

Johansson et al.: **recipient, linked**

Davenport: **structure, ordering, time, space, begin, end, measurement, ownership, innovation enabling**

Rummler & Brache: **production, support, managerial**

Summing up

Definability

Processes must have clearly defined boundaries, input and output



Structured

Processes wrap up a collection of tasks

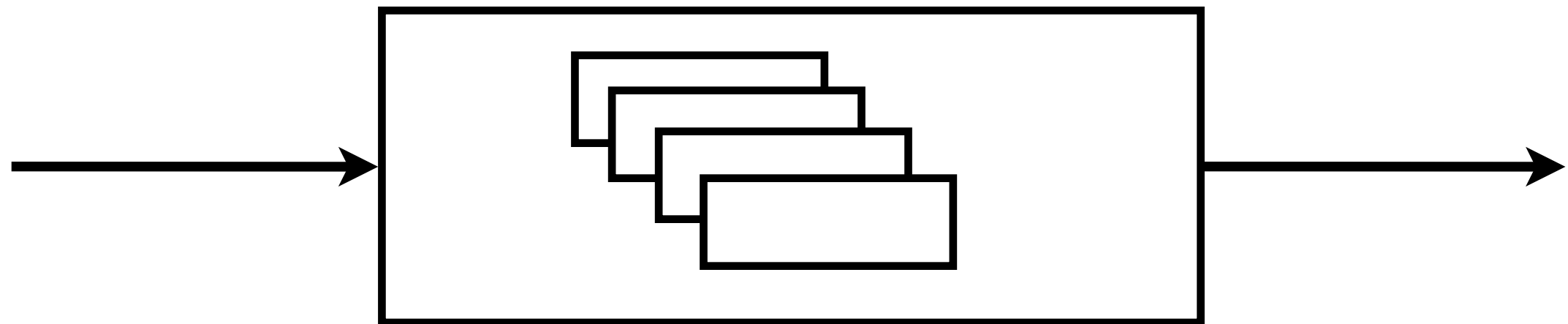

Ordered

Process tasks are ordered according to their position in time and space

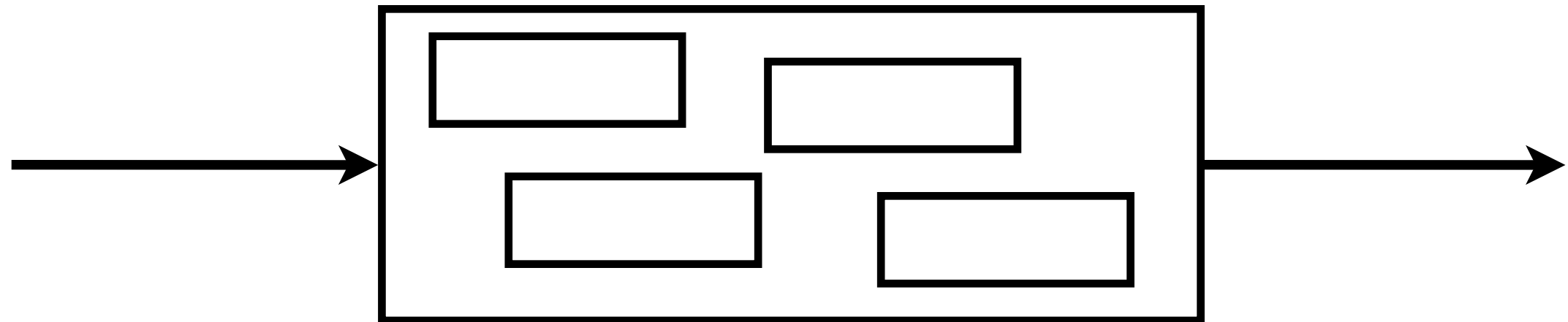

Linked

Process activities are linked along a value-added chain

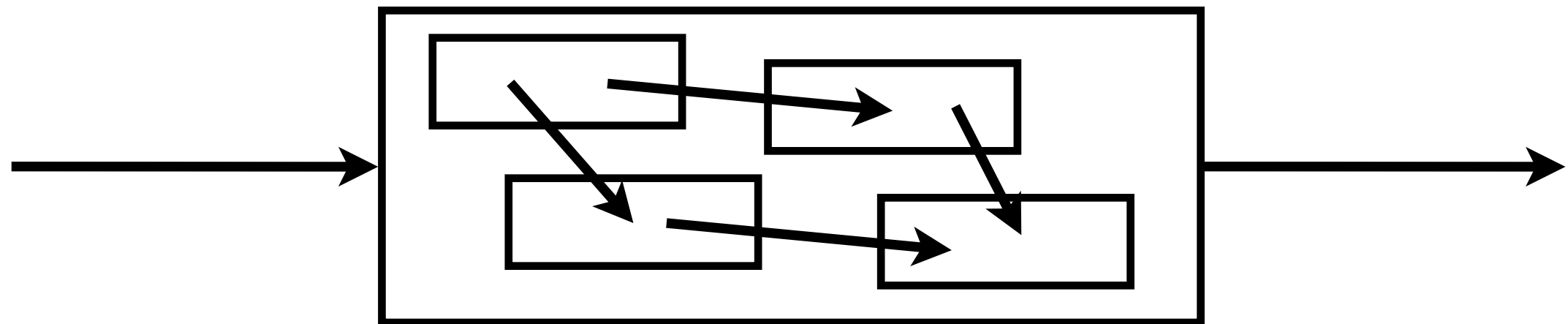

Example

$$S = \{a, b, c, d, e, f\}$$

$$a \sqsubseteq b \sqsubseteq d \sqsubseteq f \quad a \sqsubseteq c \sqsubseteq e \sqsubseteq f \quad c \sqsubseteq d$$

Which of the following are correct sequences?

abcdef

abcedf

abdcef

acebdf

acbedf

acefbd

Customer

The process output has a recipient

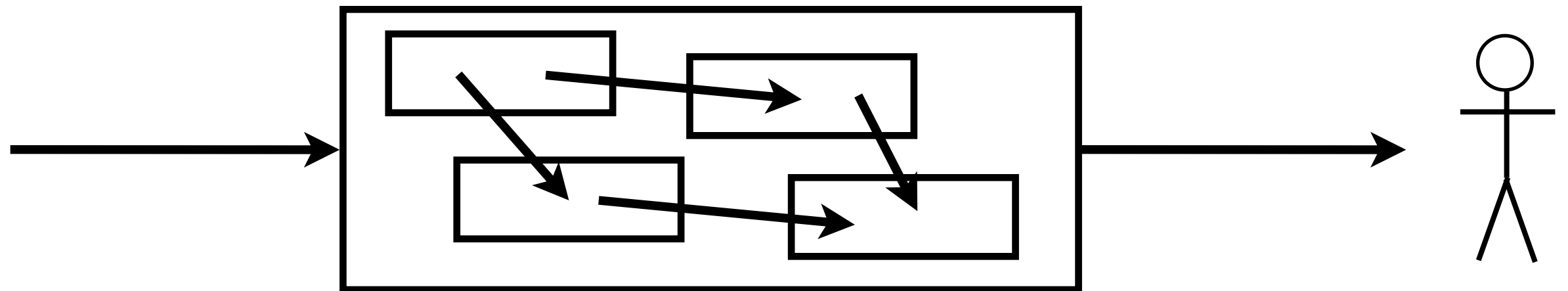

Measurability

The process output can be measured and evaluated

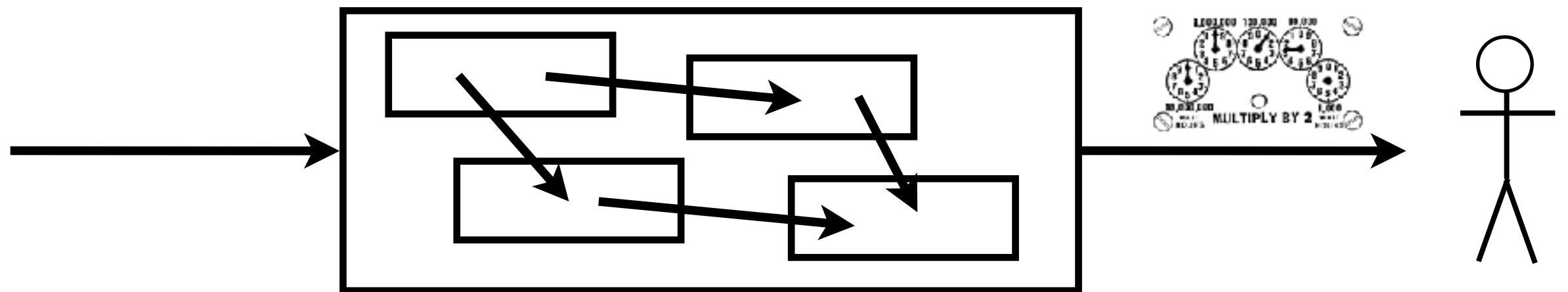

Ownership

There is one responsible for the performance and continuous improvement of the process

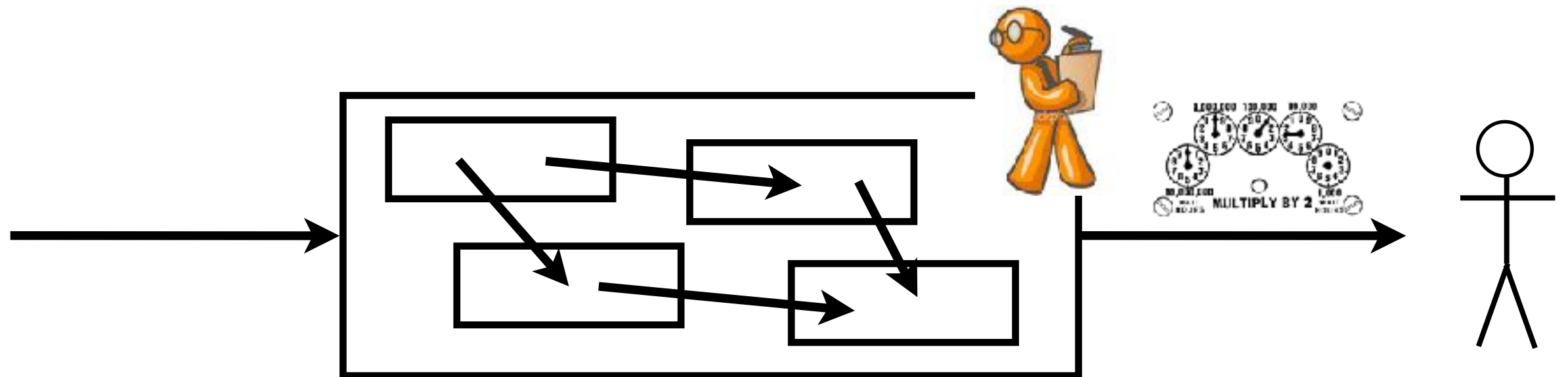

Cross-functionality

A process can span several functions within and across the organizational structure

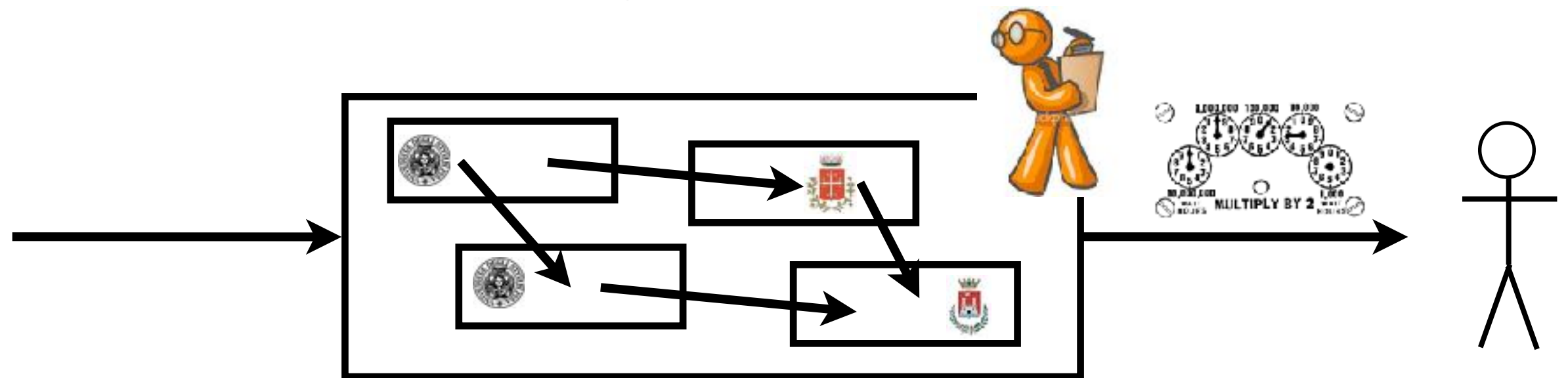

Issues

- Role of work in the society
- Organizational structures
- Principal-contractor relationship
- Processes and distribution of work
- Process management
- Some definitions**

Business process

Definition: a **business process** consists of a set of activities that are performed in coordination in an organizational and technical environment.

These activities jointly realize a business goal.

Each business process is enacted by a single organization, but it may interact with business processes performed by other organizations.

- *Weske*

Business process management

Definition: **business process management**

includes concepts, methods, and techniques to support the design, administration, configuration, enactment, and analysis of business processes.

- *Weske*

Business process management

The basis of business process management is the **explicit representation** of business processes with their **activities** and the **execution constraints** between them

Business processes can then be subject to **analysis, improvement, and enactment**

Business process management system

Definition: **business process management system** is a generic software system that is driven by explicit process representations to coordinate the enactment of business processes.

- *Weske*

Business process model

Definition: **business process model** consists of a set of activity models and execution constraints between them.

- *Weske*

Business process instance

Definition: **business process instance**

represents a concrete case in the operational business of a company, consisting of activity instances.

- *Weske*

Model and instances



Each activity model acts as a blueprint
for a set of activity instances

Each business process model acts as a blueprint
for a set of business process instances

Abuse of notation

If no confusion is possible,
the term activity is used to refer
to activity models
as well as activity instances

Analogously,
the term process is used to refer
to process models
as well as process instances

Process-driven software

Business process models are the main artifact for implementing business processes

This implementation can be done by organizational rules and policies, but it can also be done by business process management (software) system

In this case the software system is driven by explicit process representations (models)

Process representations

Visual representations: diagrams and charts
understandable by humans
(few conventions, intuitive, BPMN, EPC, BPEL)

Languages: precise syntax
understandable by machines
(process dialects, XML schemes)

Models: precise semantics
understandable by scientists
(automata, Petri nets, workflow nets, YAWL)

Narrowing the gap

Organizational business aspects

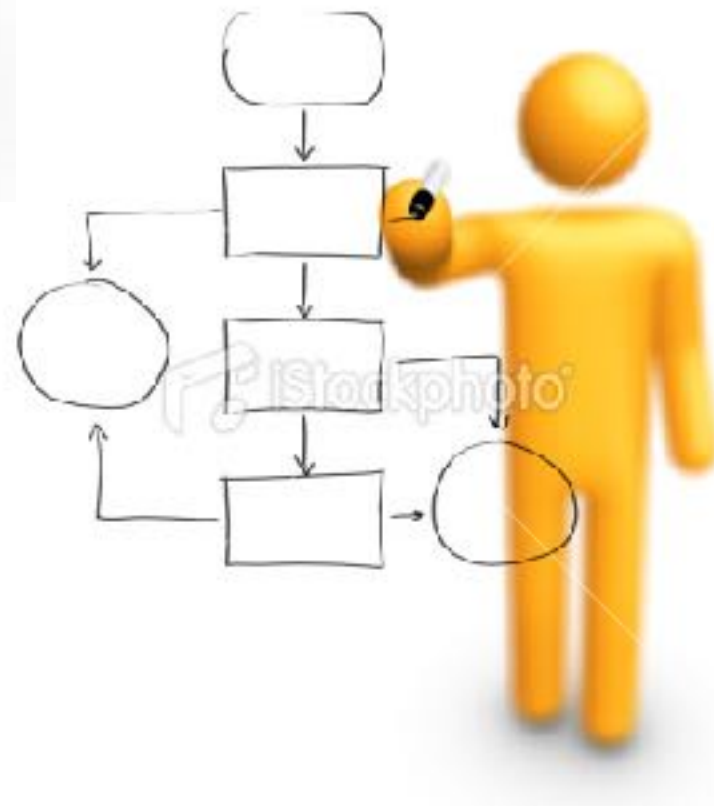

Exercise

Invent your own diagrammatic notation
to describe the following scenario
(choose symbols and shapes carefully)

Alice wants to sell her car, Bob is interested in buying it.

Alice asks some quote.

Bob can accept the bargain, refuse it or make a counteroffer.

Alice can accept or make a counteroffer and so on,

Until either the bargain is accepted or refused.