

# Business Processes Modelling

## MPB (6 cfu, 295AA)

Roberto Bruni

<http://www.di.unipi.it/~bruni>

04 - Models and Abstraction

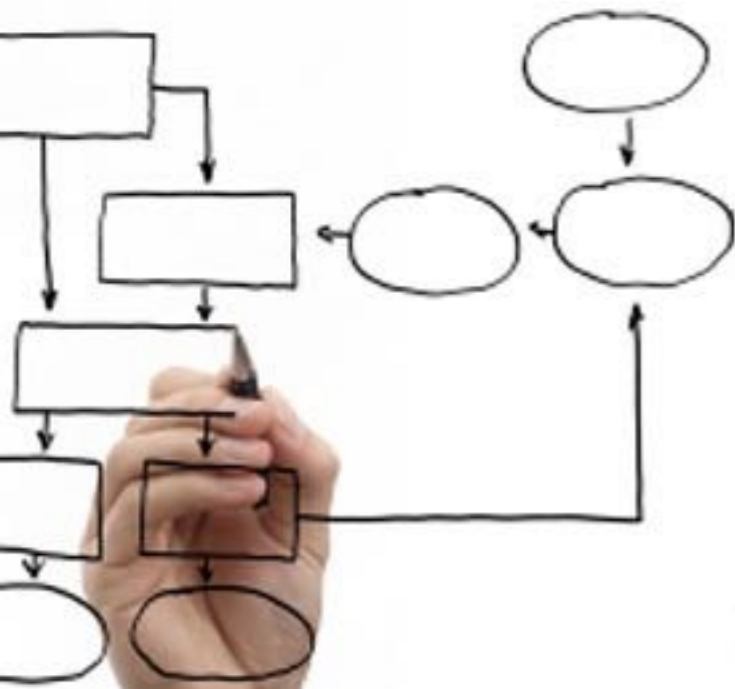

# Object

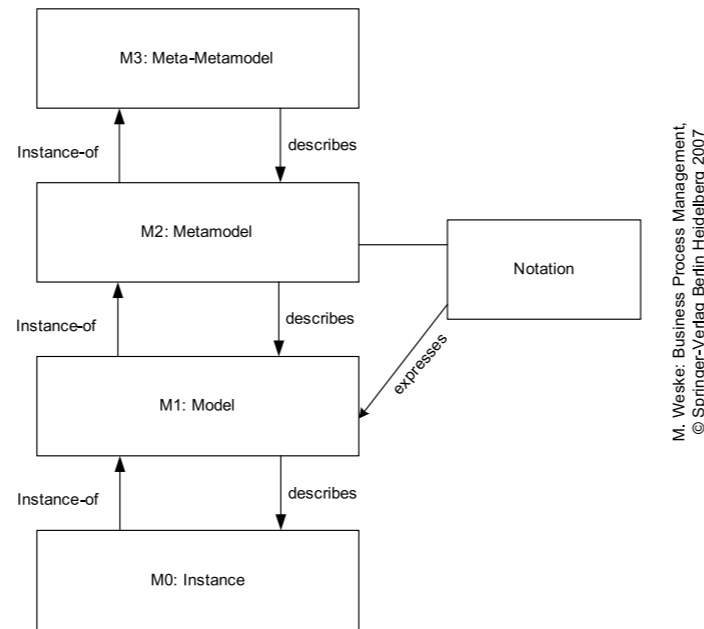

## Overview of the conceptual models and abstraction mechanisms in business process modeling

Ch.1 of Workflow Management: Models, Methods, and Systems

Ch.1 of Business Process Management: Concepts, Languages, Architectures

Ch.3.1--3.3 of Business Process Management: Concepts, Languages, Architectures

# Some definitions

# Workflow management coalition (WfMC)

Founded in the '90s by vendors, users, academia:  
fix standard for Wf representation and execution

<http://www.wfmc.org>

*Workflow Management Coalition*

**WfMC**

# Workflow

**Definition:** a **workflow** is the automation of a business process, in whole or in part,

during which documents, information, or tasks are passed from one participant to another for action,

according to a set of procedural rules



# Workflow management system

**Definition:** a **workflow management system**

is a software system

that defines, creates, and manages Wfs execution,  
running on one or more workflow engines,

able to interpret the workflow definition,

able to interact with workflow participants, and

able to invoke the use of IT tools and applications



# Kinds of workflow

**Definition:** a **system workflow** consists of activities that are implemented by software systems without any user involvement

**Definition:** Workflows in which humans are actively involved and interact with information systems are called **human interaction workflows**.

# Human interaction workflows

## **Goal:**

support automation by driving the human activities  
according to the process model

## **Benefits:**

reduce idle periods  
avoid redundant work  
improve human/machine work integration



# Human collaboration

When task performed by humans are involved in the workflow, it is not sufficient to equip workers with adequate software:

their collaboration must be supported

shared data repositories and work handover can speed-up office procedure considerably

# Example: Human interaction workflow

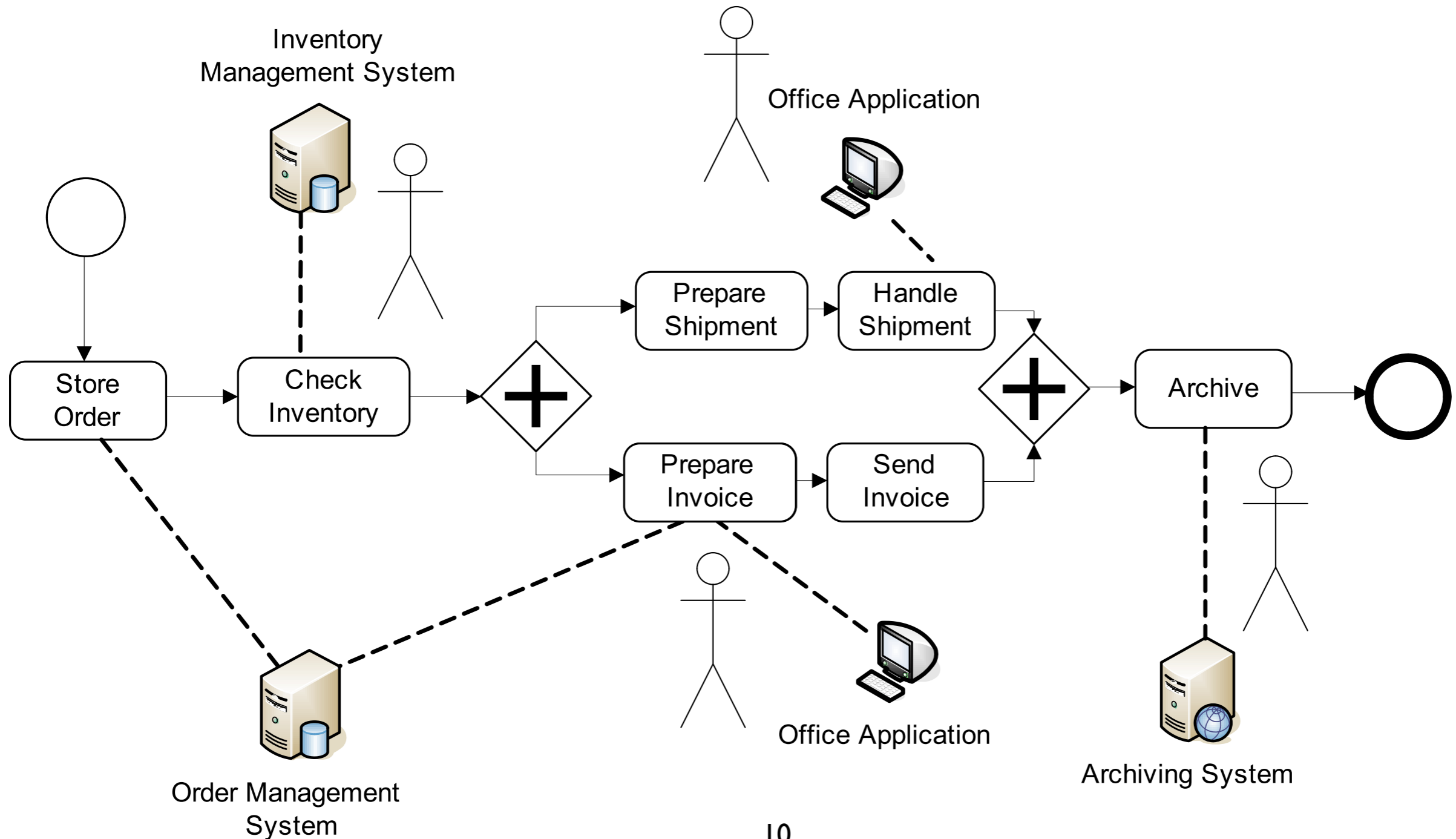

# Some limitations

Problems with knowledge workers:

User acceptance  
issues



Machine burdening  
of workers

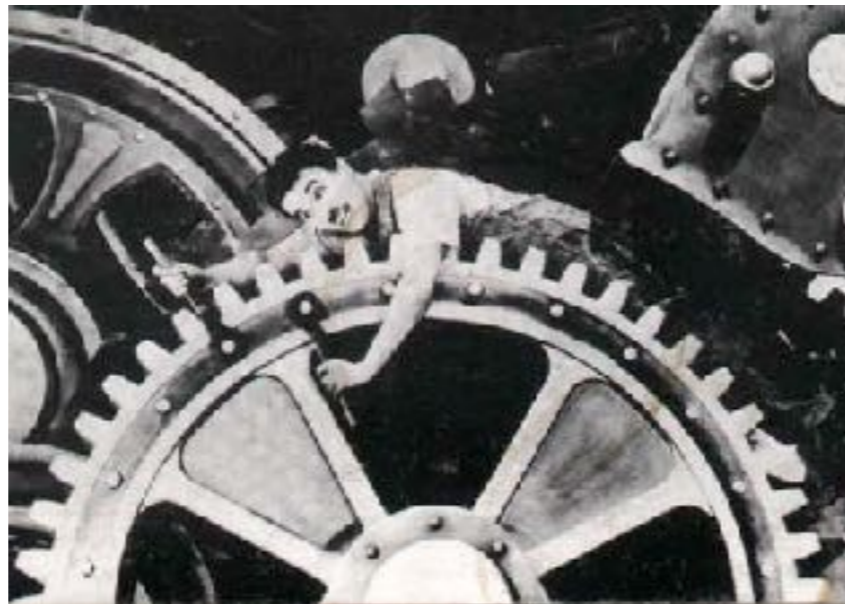

Little room for creativity  
and flexibility



# Business process

**Definition:** a **business process** consists of a set of activities that are performed in coordination in an organizational and technical environment.

These activities jointly realize a business goal.

Each business process is enacted by a single organization, but it may interact with business processes performed by other organizations.

- *Weske*



# Business process management

**Definition:** **business process management**

includes concepts, methods, and techniques to support the design, administration, configuration, enactment, and analysis of business processes.

- *Weske*



# Business process management

The basis of business process management is the **explicit representation** of business processes with their **activities** and the **execution constraints** between them

Business processes can then be subject to **analysis, improvement, and enactment**

# Business process management system

**Definition:** **business process management system** is a generic software system that is driven by explicit process representations to coordinate the enactment of business processes.

- *Weske*



# Business process model

**Definition:** **business process model** consists of a set of activity models and execution constraints between them.

- *Weske*





# Business process instance

**Definition: business process instance**

represents a concrete case in the operational business of a company, consisting of activity instances.

- *Weske*



# Model and instances



Each activity model acts as a blueprint  
for a set of activity instances

Each business process model acts as a blueprint  
for a set of business process instances  
(related to cases)

# Abuse of notation

If no confusion is possible,  
the term activity is used to refer  
to activity models  
as well as activity instances

Analogously,  
the term process is used to refer  
to process models  
as well as process instances

# Process-driven software

Business process models are the main artifact for implementing business processes

This implementation can be done by organizational rules and policies, but it can also be done by business process management (software) system

In this case the software system is driven by explicit process representations (models)

# Process representations

**Visual representations:**  
diagrams and charts  
understandable by humans

(informal, intuitive, BPMN, EPC, BPEL)

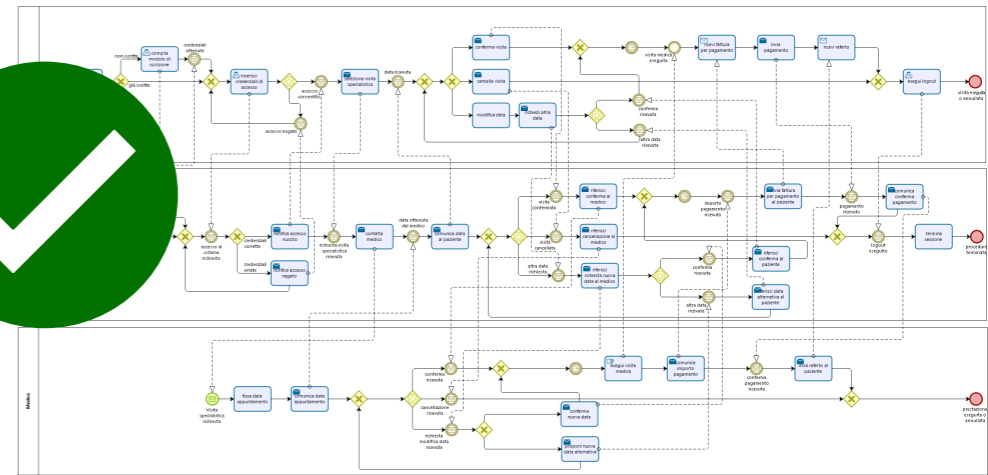

**Languages:**

unambiguous machine syntax  
(process dialects, XML schemes)



```
1 <?xml version="1.0" ?>
2 <xsi:schemaLocation xmlns:xsi="http://www.w3.org/2001/XMLSchema" xmlns:xs="http://www.w3.org/
3   instance" id="_2619811287476" targetNamespace="http://www.bizagi.com/
4   9011287478" xmlns="http://www.omg.org/spec/BPMN/20180524/MODEL">
5   <process id="Id_1184d428-5114-4a51-a56c-4b24ae1da1b3" name="Processo principale">
6     <startEvent id="Id_b105ba3a-1bbb-4efd-bece-dc9cda12eeeb" type="start" />
7     <task id="Id_15079acc-89ed-4ad7-b441-1578d50b82a8" type="task" />
8     <task id="Id_ebca1c69-4d72-4516-8b3e-2367442957ab" type="task" />
9     <event id="Id_254c9cde-6b8c-42be-a151-55ed4e87b322" type="intermediateCatchEvent" name="conferma
10    ricevuta">
```

**Models:**

rigorous semantics for scientists  
(automata, Petri nets, workflow nets)

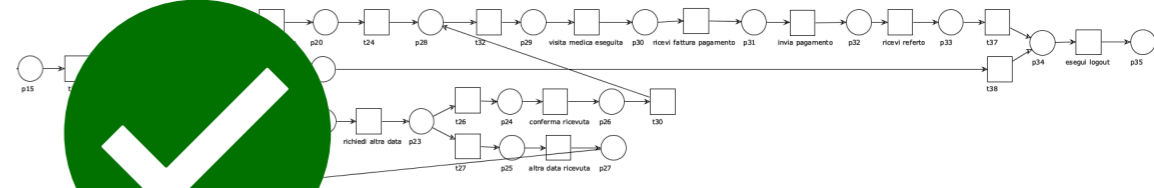
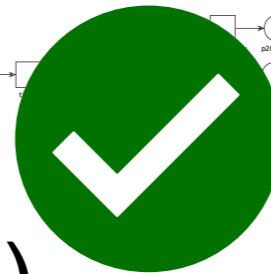

# Models and abstraction

# Models

A model is a simplified representation of reality

*"Essentially all models are wrong,  
but some are useful"*  
(George P. Box)

# Abstraction

**To derive general rules and concepts**  
from specific examples of some phenomenon,  
by selecting only the aspects which are relevant  
for a particular purpose

A way to cope with complexity



# Abstractions

**Horizontal:** separation at different modeling levels

**Aggregation:** separation at different granularity levels

**Vertical:** separation at different subdomains

# Horizontal Abstraction

# Horizontal abstraction (modeling levels)

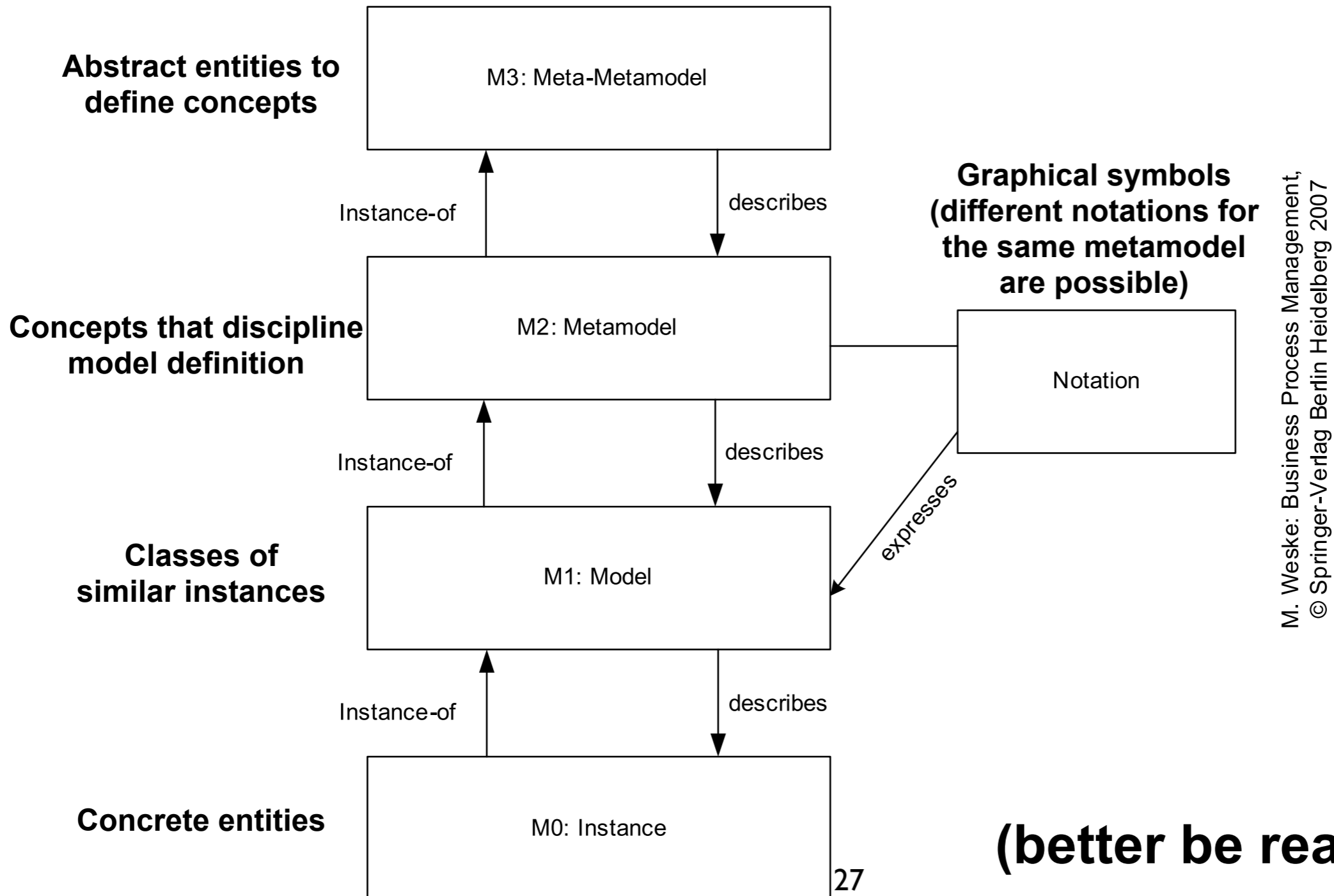

M. Weske: Business Process Management,  
© Springer-Verlag Berlin Heidelberg 2007

# Process models and process instances

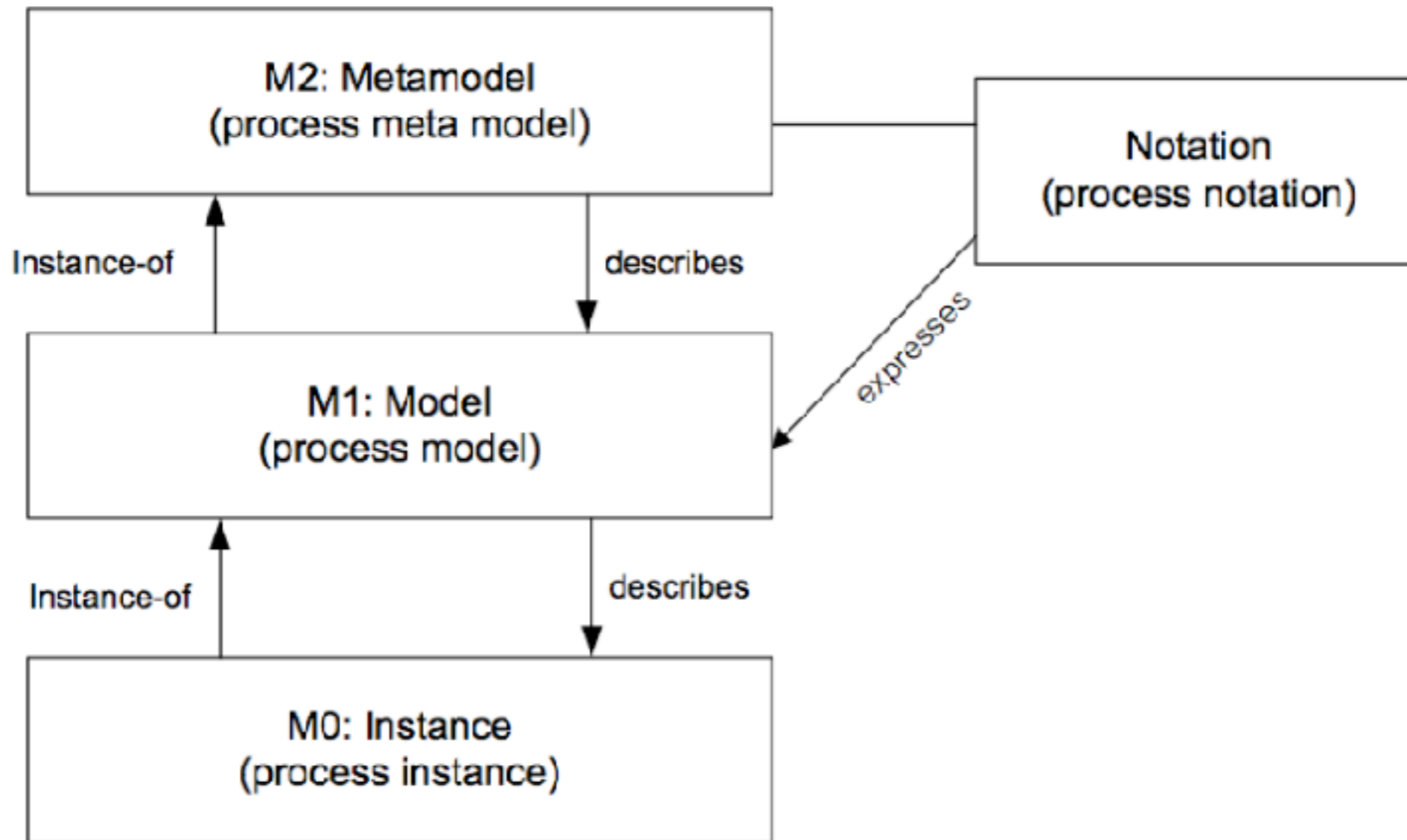

# A process metamodel (level M2)

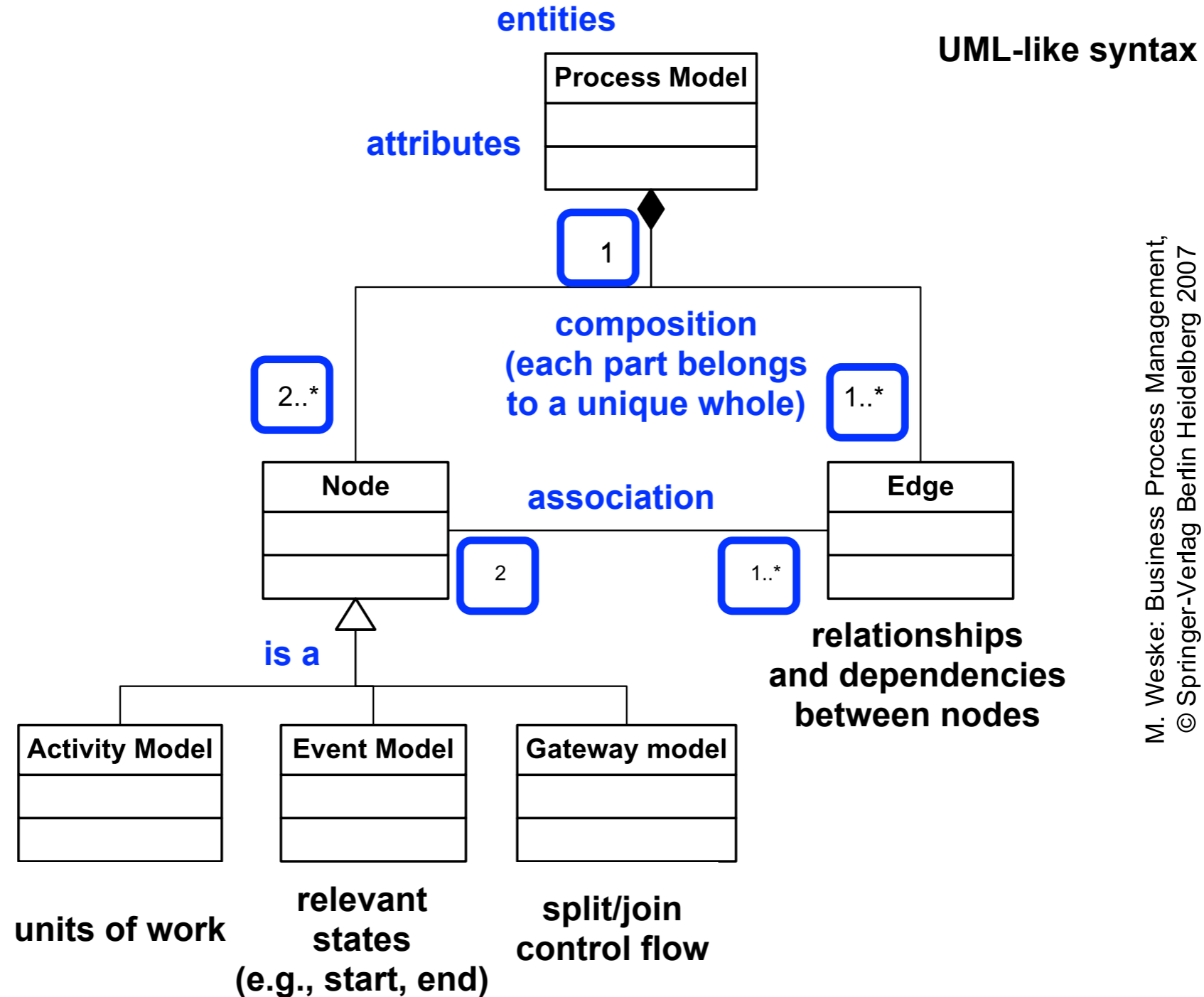

M. Weske: Business Process Management,  
© Springer-Verlag Berlin Heidelberg 2007

# A process model

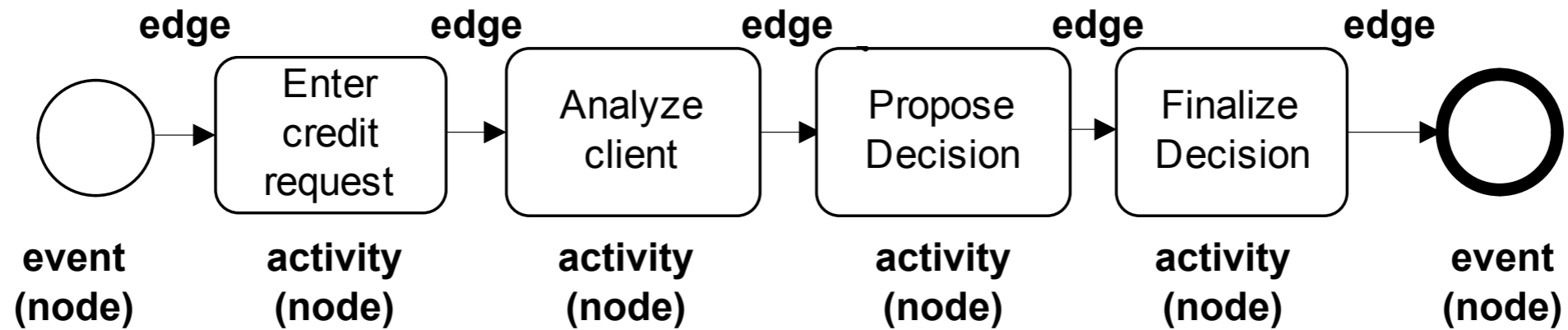

# Some process instances

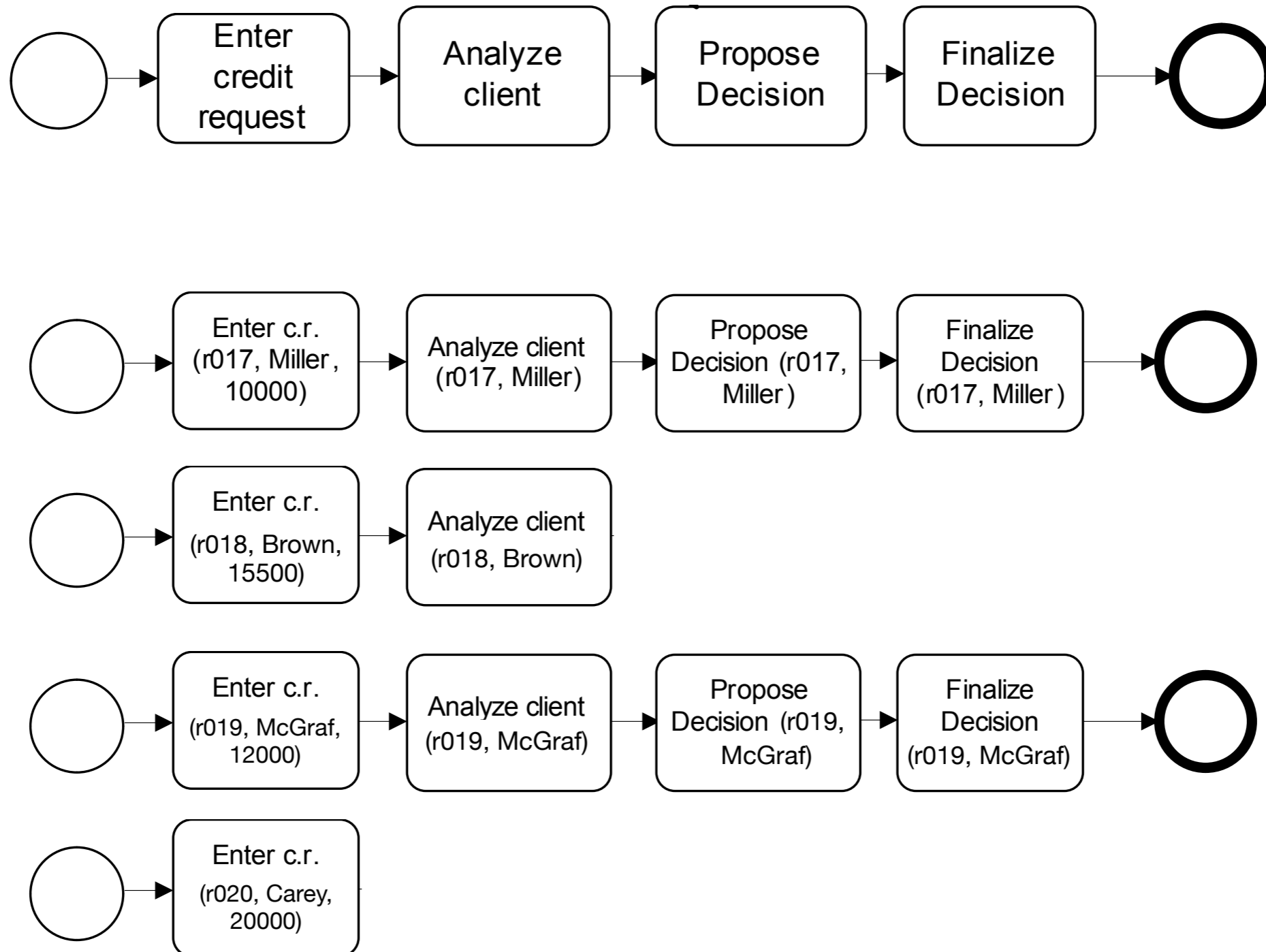

# Process models and process instances

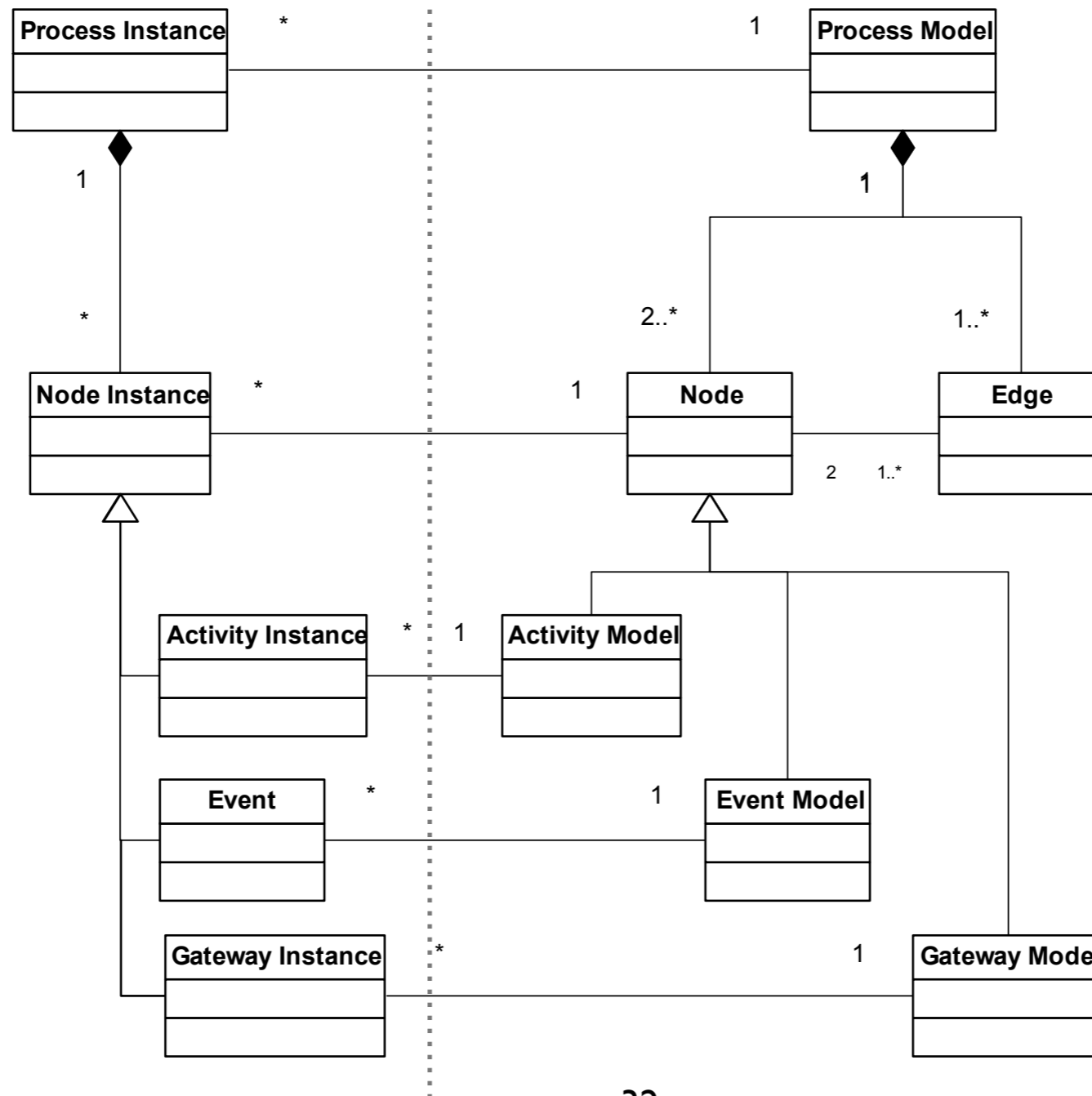

M. Weske: Business Process Management,  
© Springer-Verlag Berlin Heidelberg 2007



# An example: MOF metamodel (OMG)

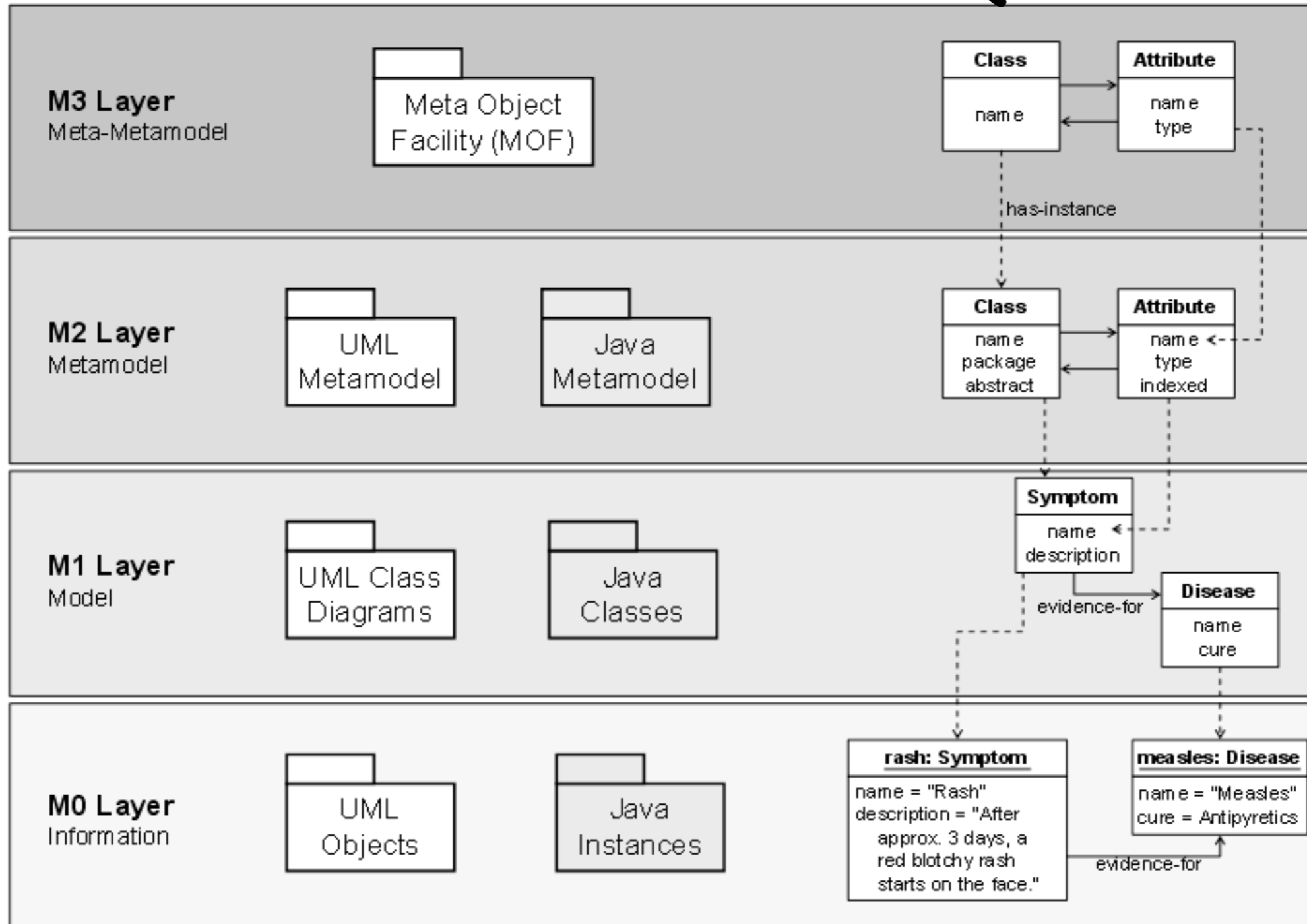

# Aggregation Abstraction

# Aggregation abstraction

Multiple elements of a lower level of granularity can be grouped and represented by a single artefact at the higher level of granularity

Different from horizontal abstraction, where all entities lie at the same level of granularity

# A sample aggregation

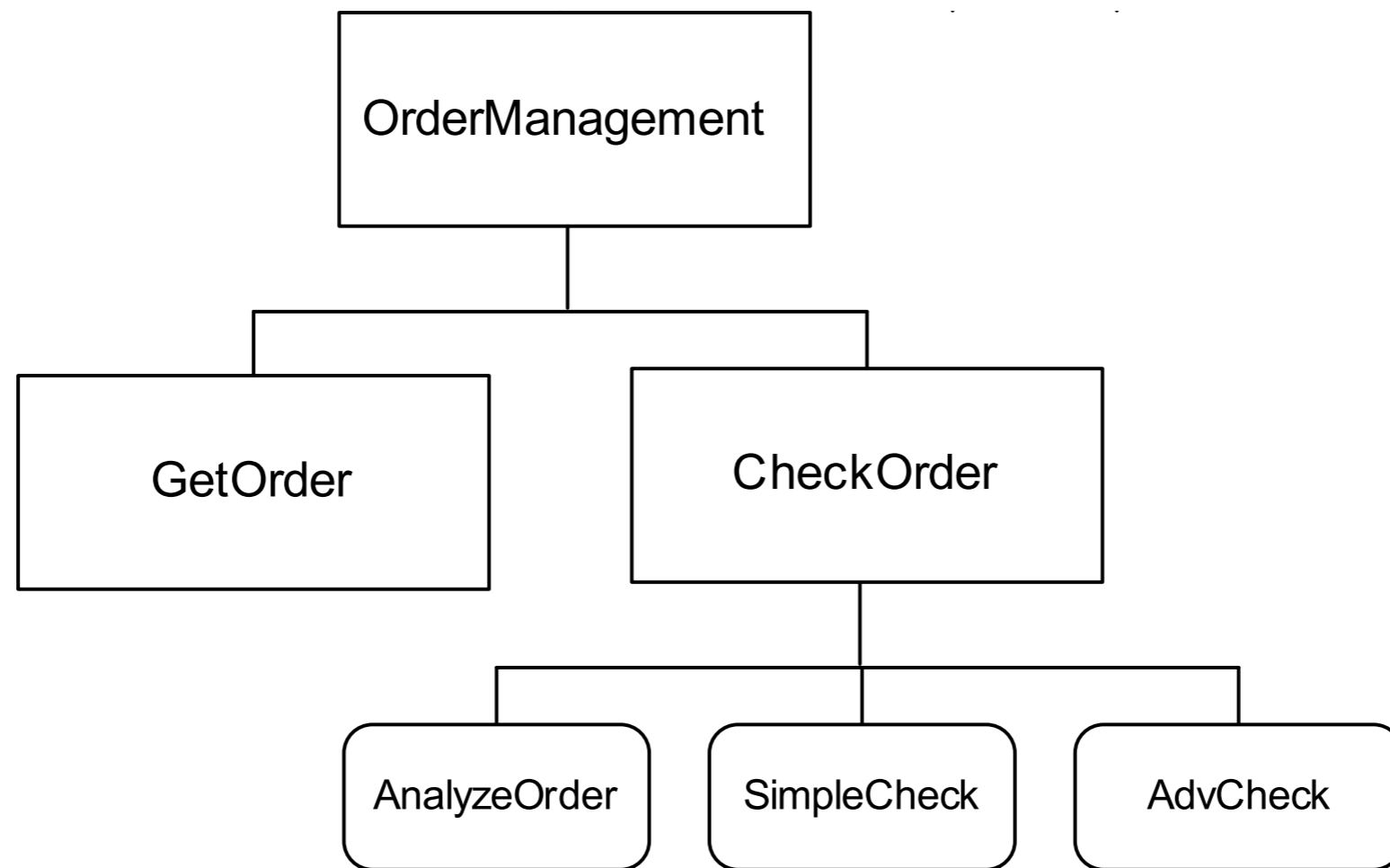

# Vertical Abstraction

# Guiding principle

## **Separation of Concerns (SoC)**

(to separate a system into distinct features that overlap in functionality as little as possible)

# E. W. Dijkstra Archive

the manuscripts of

# Edsger W. Dijkstra

1930–2002

Search transcriptions:

Search

[Advanced search.](#)

[Home](#)

[Search](#)

Numerical  
EWD Index:

[00xx](#)  
[01xx](#)  
[02xx](#)  
[03xx](#)  
[04xx](#)  
[05xx](#)  
[06xx](#)  
[07xx](#)  
[08xx](#)  
[09xx](#)  
[10xx](#)  
[11xx](#)  
[12xx](#)  
[13xx](#)



©2002 Hamilton Richards)

(photo

Edsger Wybe Dijkstra was one of the most influential members of computing science's founding generation. Among the domains in which his scientific contributions are fundamental are

- algorithm design
- programming languages
- program design
- operating systems
- distributed processing
- formal specification and verification
- design of mathematical arguments

In addition, Dijkstra was intensely interested in teaching, and in the relationships between academic computing science and the software industry.

<http://www.cs.utexas.edu/users/EWD/>



# On the role of scientific thought (EWD447)

*Let me try to explain to you, what to my taste is  
**characteristic for all intelligent thinking.***

*It is, that one is willing to study in depth an aspect of one's  
subject matter  
**in isolation for the sake of its own consistency,**  
all the time knowing that one is occupying oneself only with  
one of the aspects.*





*We know that a program must be **correct** and we can study it from that viewpoint only; we also know that it should be **efficient** and we can study its efficiency on another day, so to speak. In another mood we may ask ourselves whether, and if so: why, the program is **desirable**.*

***But nothing is gained —on the contrary!— by tackling these various aspects simultaneously.***

*It is what I sometimes have called **the separation of concerns**, which, even if not perfectly possible, is yet the only available technique for effective ordering of one's thoughts, that I know of.*

*It does not mean ignoring the other aspects, it is just doing justice to the fact that **from this aspect's point of view, the other is irrelevant**.*

*Business data processing systems are sufficiently complicated to require such a separation of concerns.*



# On the role of scientific thought (EWD447)

*... and the suggestion that in that part of the computing world*

*"scientific thought is a non-applicable luxury"*

*puts the cart before the horse: the mess they are in has been caused by **too much unscientific thought....***

# SoC: an example

HyperText Markup Language (HTML):  
organization of webpage content

Cascading Style Sheets (CSS):  
definition of content presentation style

JavaScript (JS):  
user interactions

```
<!DOCTYPE html>
<html>
<style>
body {
  background-color: lightblue;
}
h1 {
  color: darkblue;
  text-align: center;
}
p {
  font-family: verdana;
  font-size: 20px;
}
</style>

<body>

<h1>HTML, CSS and JAVASCRIPT</h1>

<button type="button"
  onclick="document.getElementById('demo').innerHTML = Date()";
Click me to display Date and Time.
</button>

<p id="demo"></p>

</body>
</html>
```

CSS

Javascript

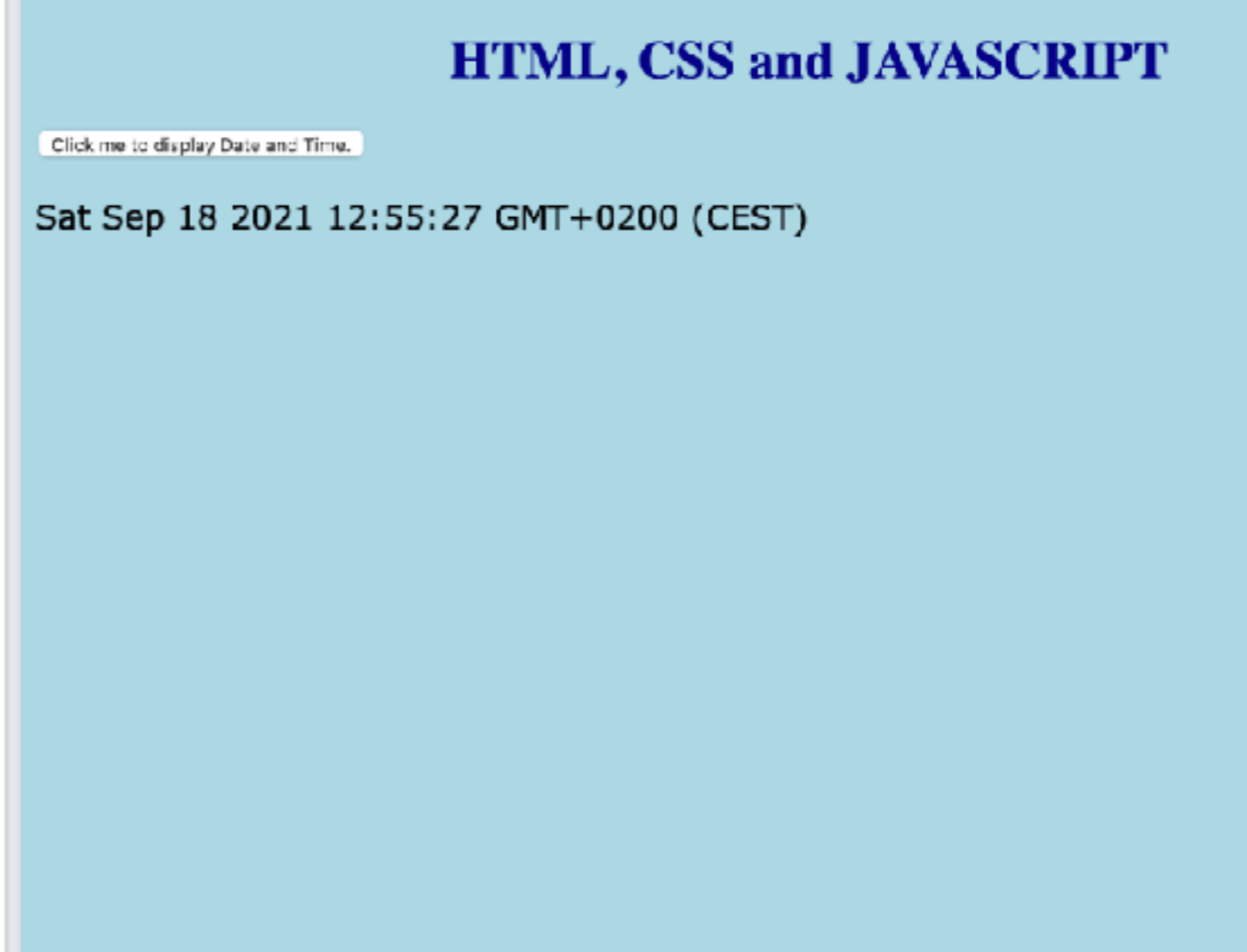

```
<!DOCTYPE html>
<html>
<style>
body {
  background-color: lightyellow;
}
h1 {
  color: darkred;
  text-align: center;
}
p {
  font-family: courier;
  font-size: 15px;
}
</style>
```

CSS



# Vertical abstraction (domain separation)

BPM includes multiple modelling domains,  
integrated by Process Modelling

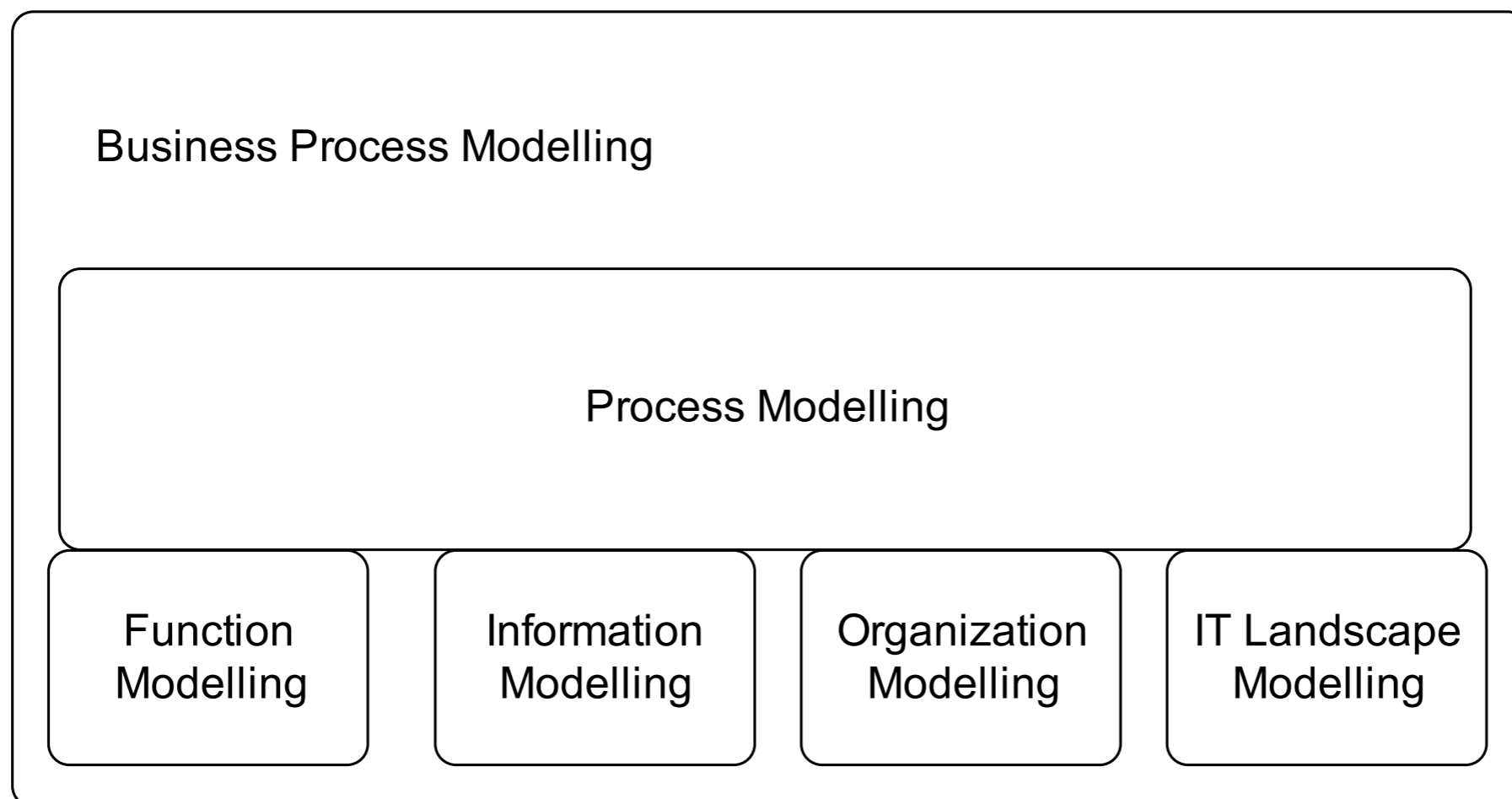

# Function models

Units of work enacted by processes  
(at different levels of granularity)

Informal description, textual documents  
(coarse-grain business level)

Formal description, function specifications  
(fine-grain software layer)

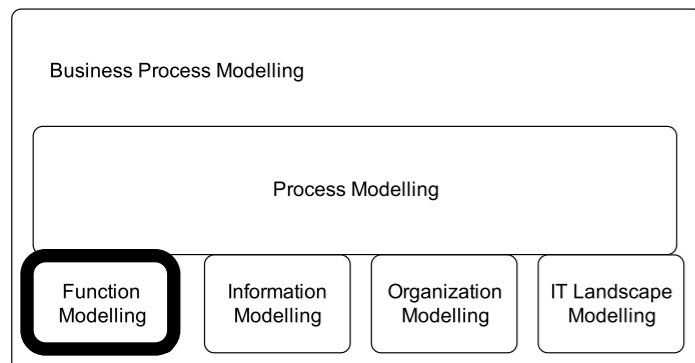

# High-level business functions

The value chain of a company has a rich internal structure, consisting of a set of coarse-grained business functions  
(e.g. Order management, Human resources)

High-level business functions can be decomposed into finer-grained functions  
(this is called **functional decomposition**)  
(e.g. from ``Order management'' to ``storing'' and ``checking'' orders)

# Activity models and activity instances

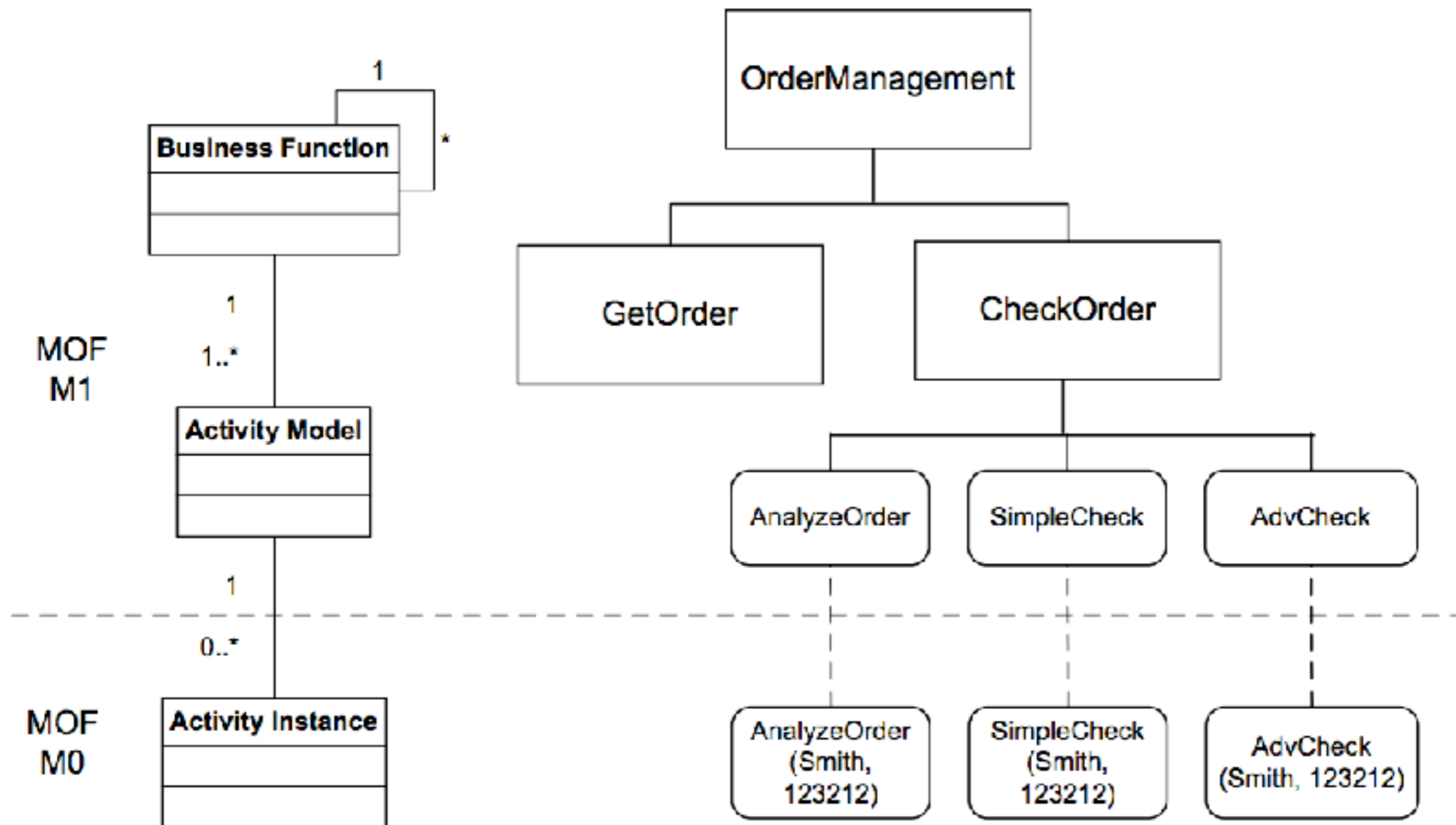



# Information models

Data representation is crucial:  
all decisions made during a business process  
depends on data values

Data dependencies between activities  
are also important  
(ensure data-availability, reduce waiting time)

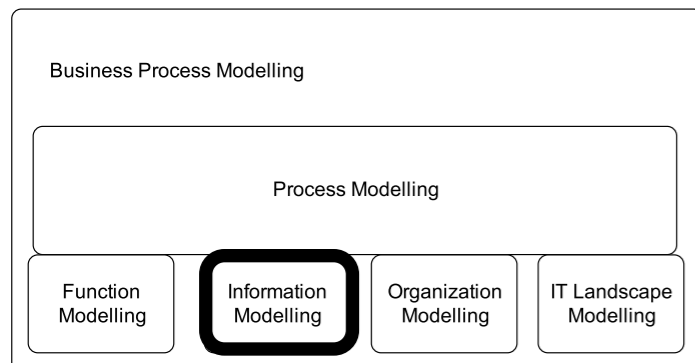

# Data models

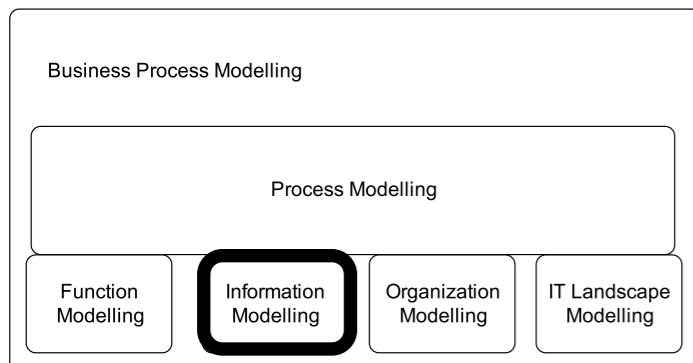
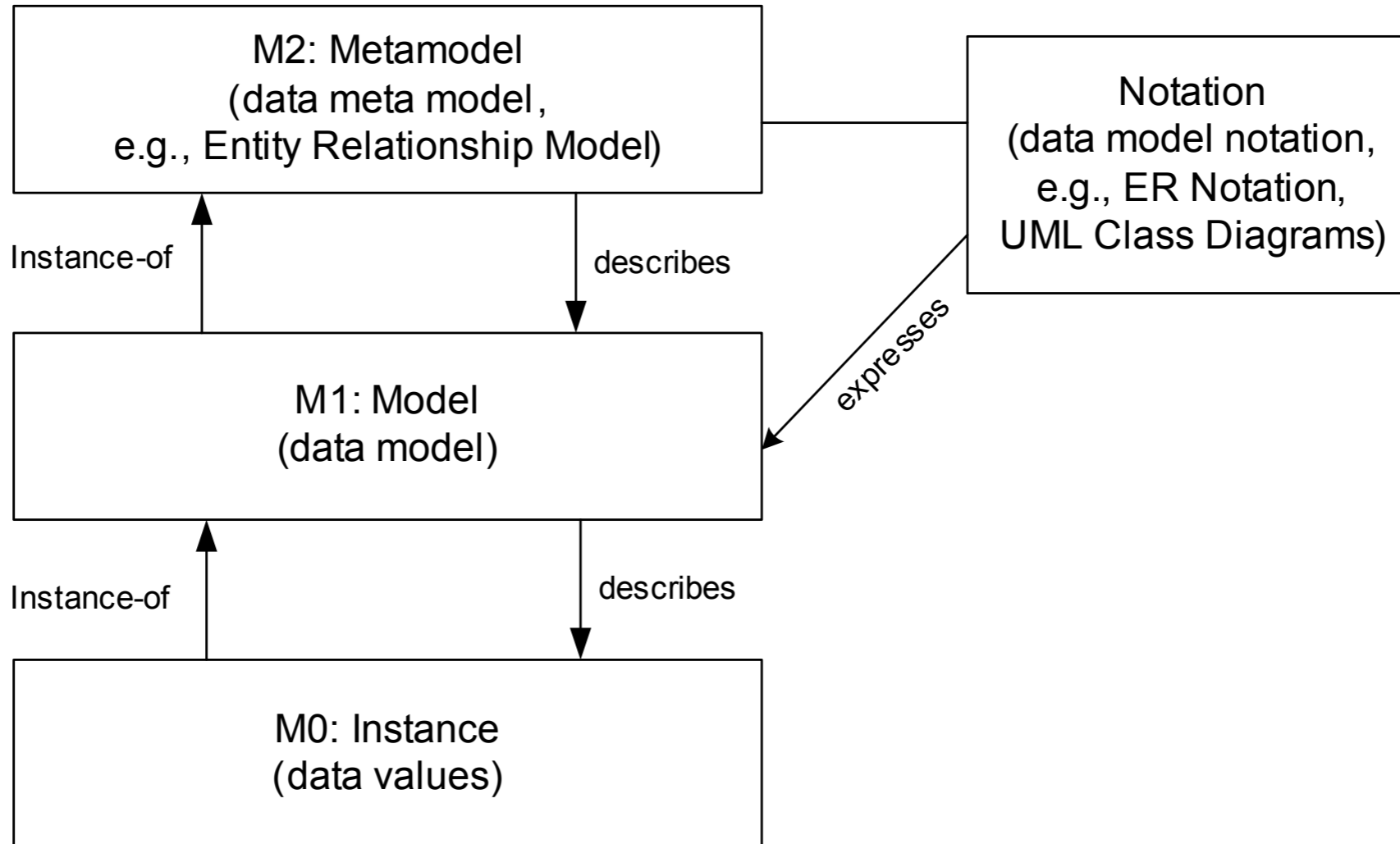

M. Weske: Business Process Management,  
© Springer-Verlag Berlin Heidelberg 2007

# Organizational models

Organizational structure must be represented

Activities must be associated  
to specific roles or departments

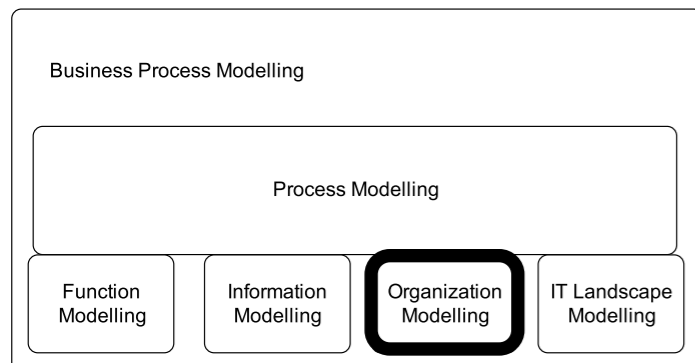

# Organizational models

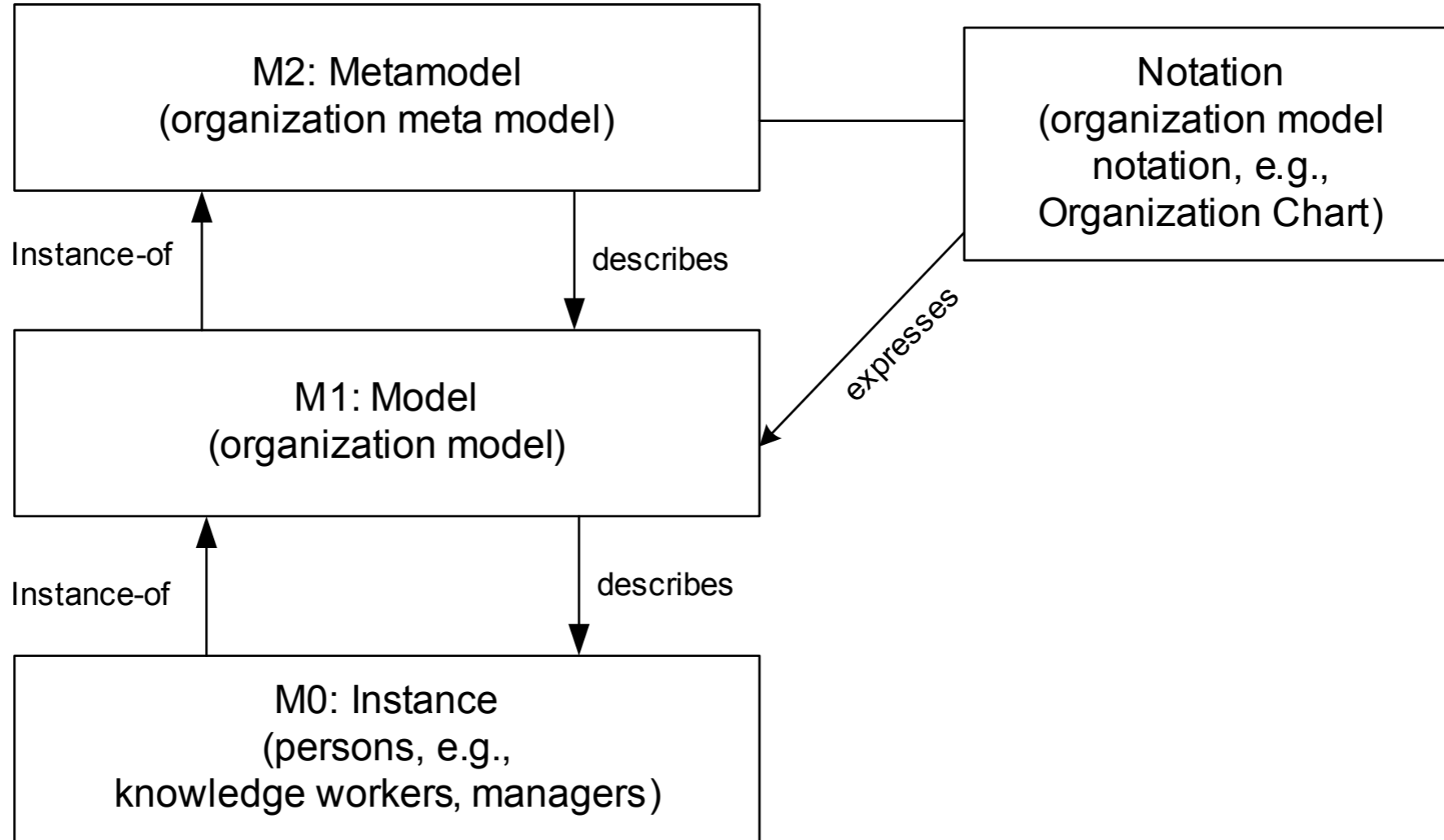

M. Weske: Business Process Management,  
© Springer-Verlag Berlin Heidelberg 2007

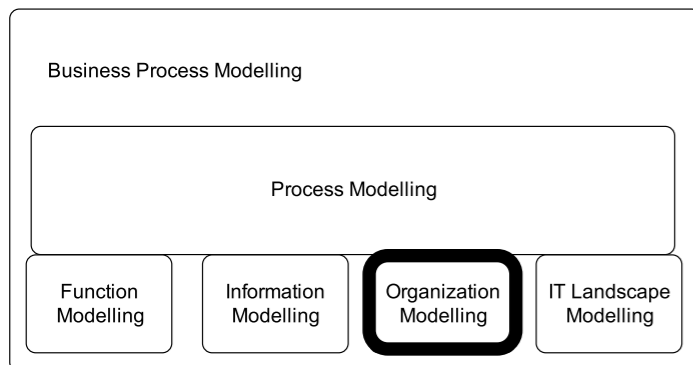

# Roles

**Roles** are groups of employees that qualify for being responsible of certain activities.

Increased flexibility:  
different persons can cover the same role at different time in different cases

# An organizational metamodel

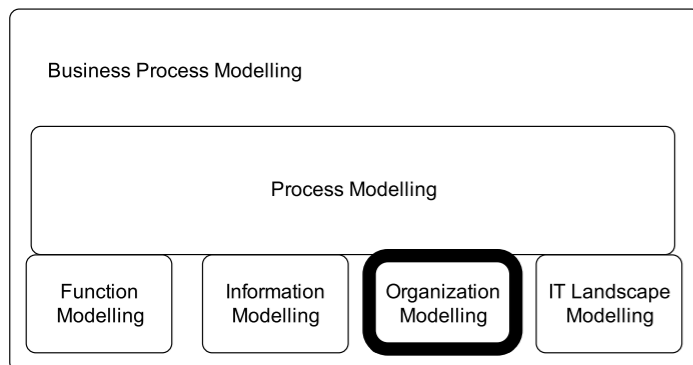
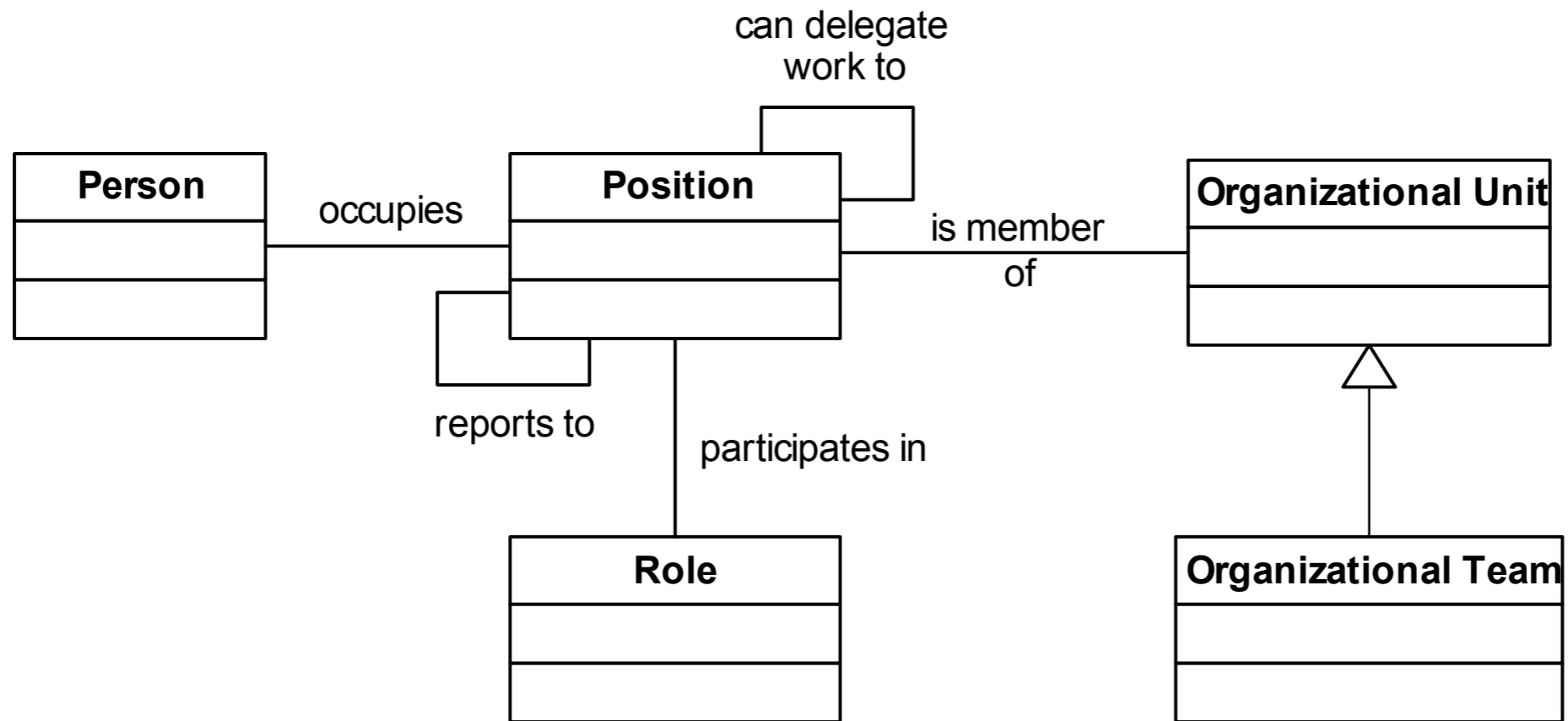

M. Weske: Business Process Management,  
© Springer-Verlag Berlin Heidelberg 2007

# IT landscape

Many activities in a business process are supported by information systems

Information systems and programming interfaces needs to be represented because they provide functionalities

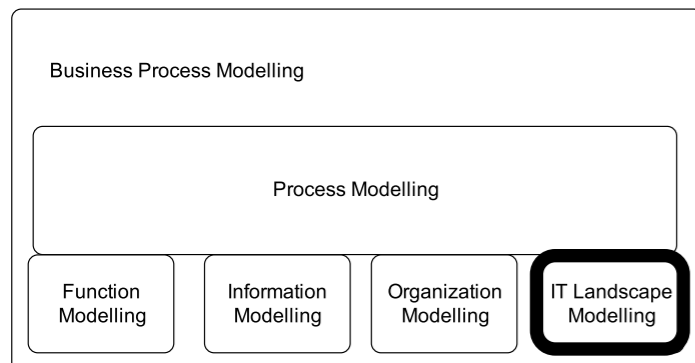

# Interface Definition Languages

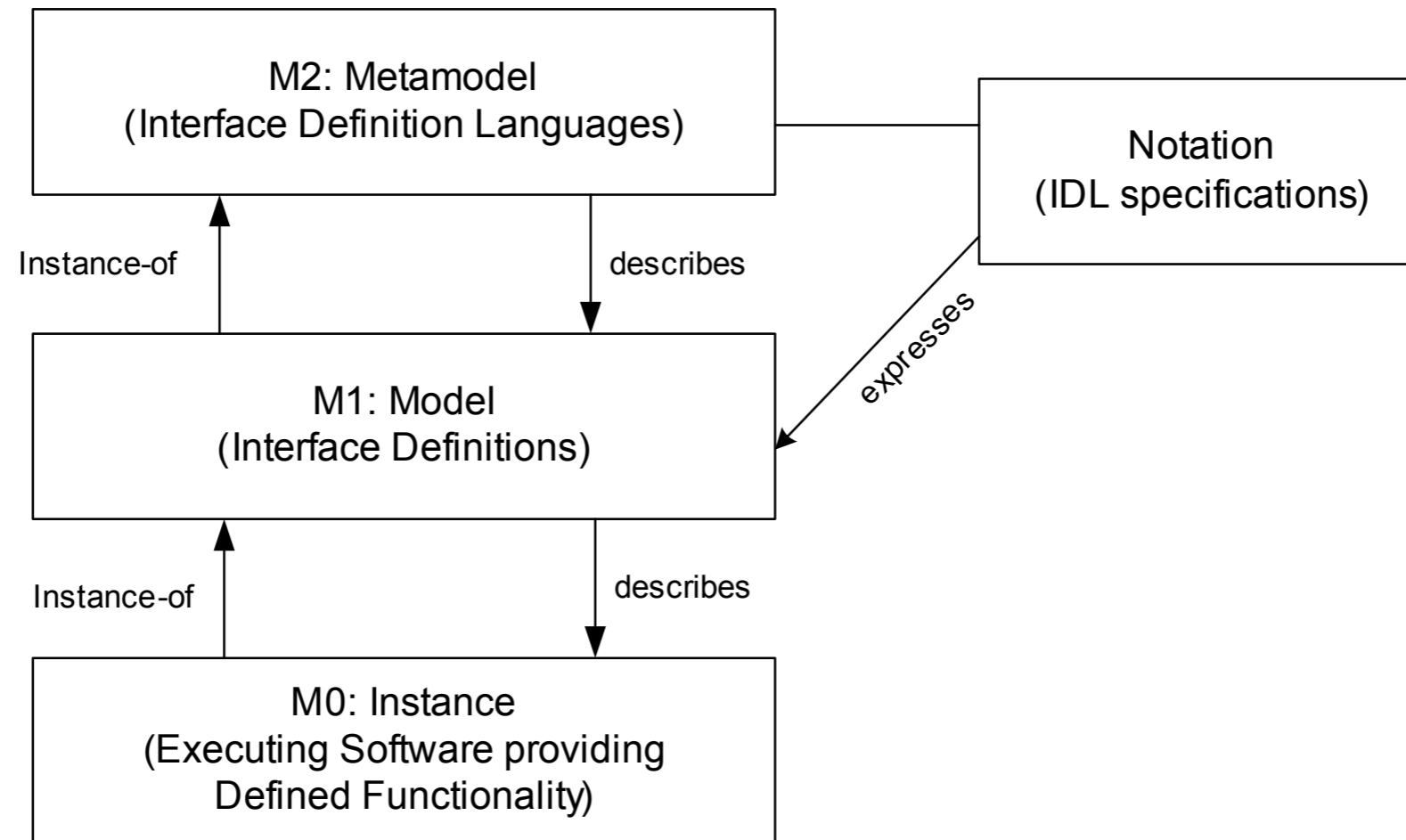

M. Weske: Business Process Management,  
© Springer-Verlag Berlin Heidelberg 2007

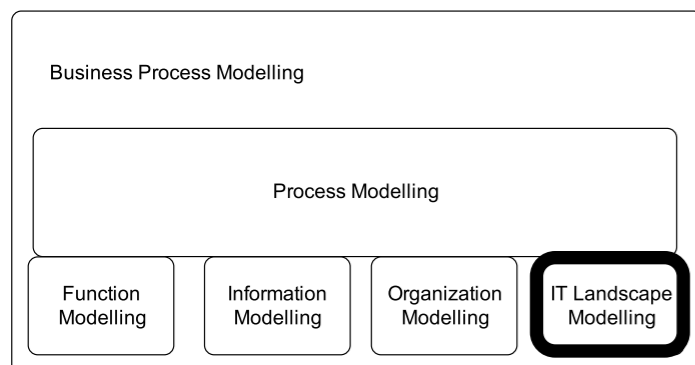



# Process models

Define the glue between the subdomains

Relate functions and execution constraints

Relate data values with process instances  
(e.g. the process of a credit approval may depend on the requested amount)

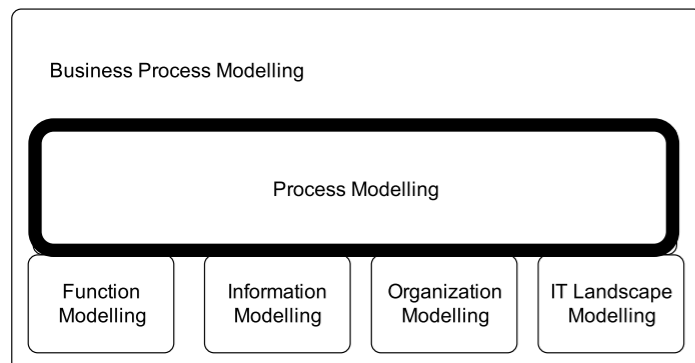

# A process model with role information

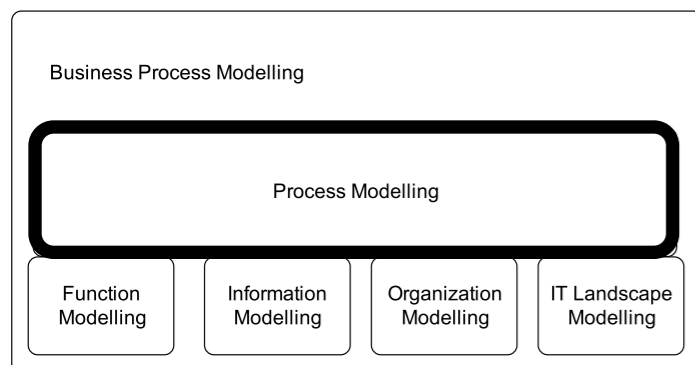
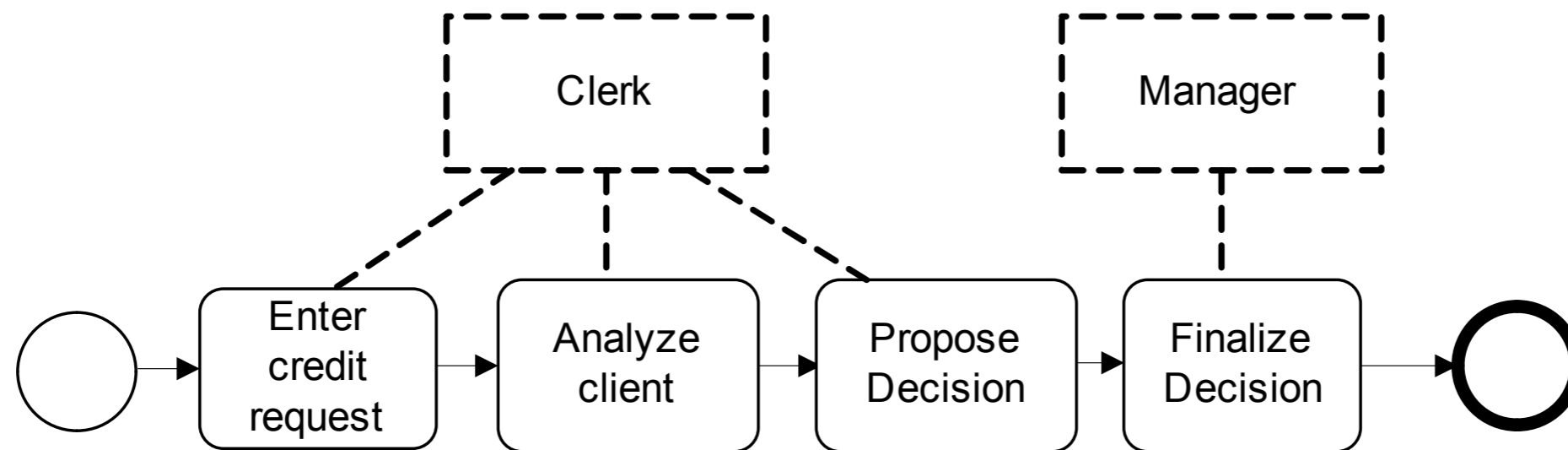

M. Weske: Business Process Management,  
© Springer-Verlag Berlin Heidelberg 2007

# A process instance with workers information

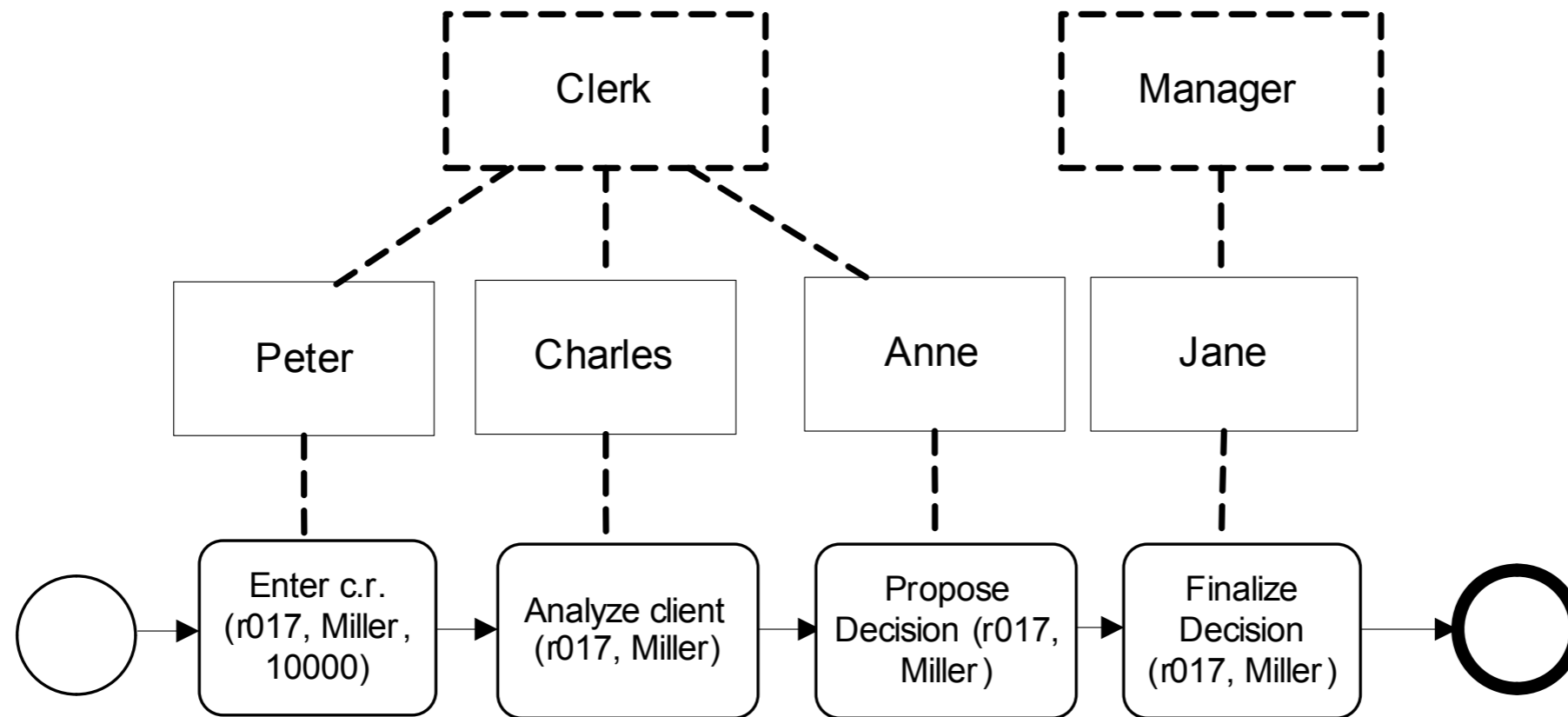

M. Weske: Business Process Management,  
© Springer-Verlag Berlin Heidelberg 2007

