

Business Processes Modelling

MPB (6 cfu, 295AA)

Roberto Bruni

<http://www.di.unipi.it/~bruni>

12 - Some Facts



Object

$$N \vdash \psi$$

We survey
two connectedness theorems and
five exchange lemmas

Free Choice Nets (book, optional reading)

<https://www7.in.tum.de/~esparza/bookfc.html>

Two theorems on strong
connectedness
(whose proofs are
optional reading)

Strong connectedness theorem

Theorem: If a weakly connected system is live and bounded then it is strongly connected

(the proof requires some Exchange Lemmas
that we illustrate later)

Consequences

If a (weakly-connected) net is not strongly connected

then

It is not live and bounded

If it is live, it is not bounded

If it is bounded, it is not live

Example

It is now immediate to see that this system
(weakly connected, not strongly connected)
cannot be live and bounded
(it is live but not bounded)

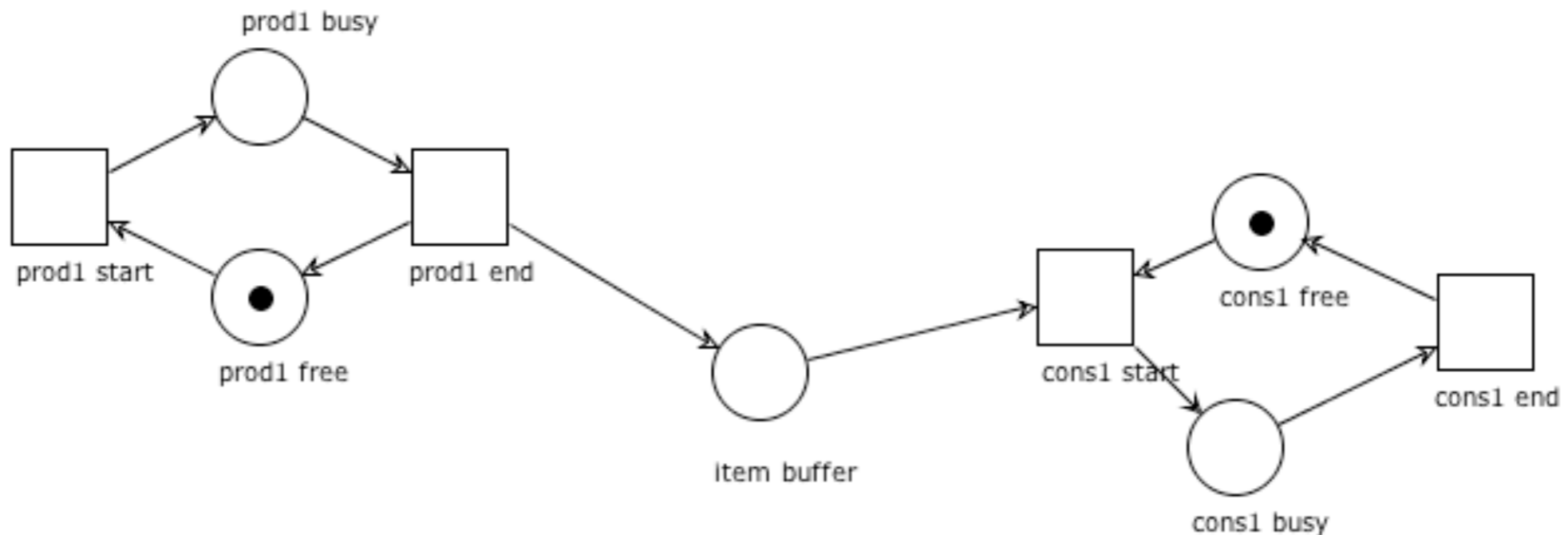

Exercise

On the basis of the previous observation:

Draw a net that is bounded but not live

Draw a net that is neither live nor bounded

(all nets must be weakly connected)

Strong connectedness via invariants

Theorem: If a weakly connected net has a positive S-invariant I and a positive T-invariant J then it is strongly connected

Consequences

If a (weakly-connected) net is not strongly connected

then

we cannot find (two) positive S- and T-invariants

Five Exchange Lemmas
(whose proofs are
optional reading)

Exchange lemma: finite sequences (1)

Lemma: Let $u, v \in T$ with $\bullet u \cap v \bullet = \emptyset$.
If $M \xrightarrow{vu} M'$, then $M \xrightarrow{uv} M'$

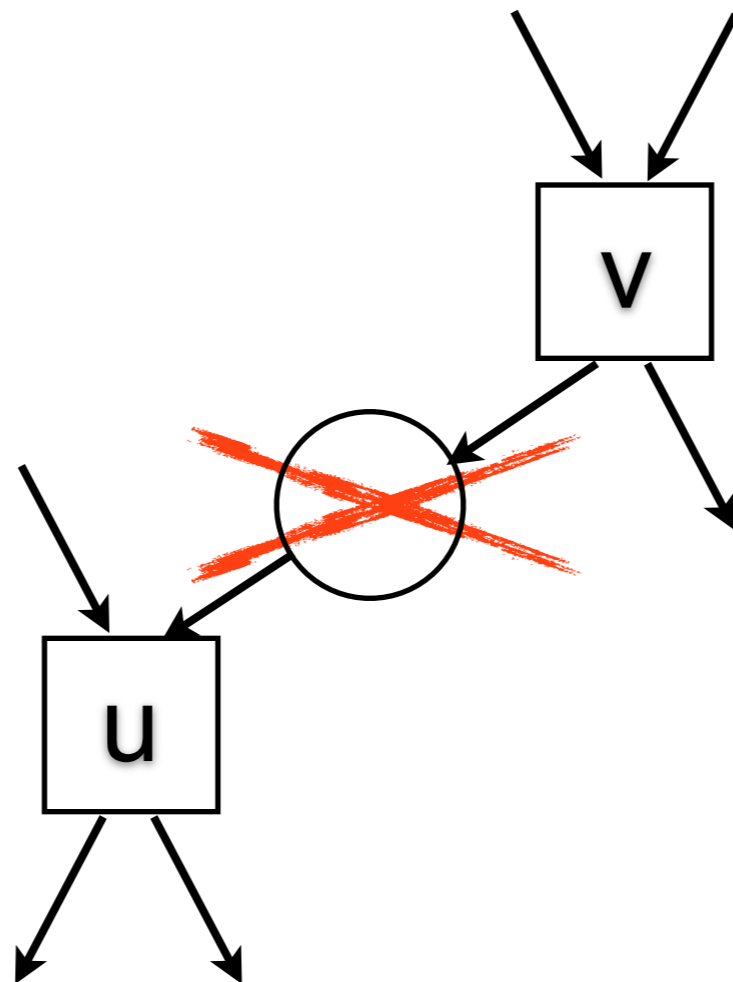

Exchange lemma:

finite sequences (2)

Lemma: Let $V \subset T$ and $u \in T \setminus V$, with $\bullet u \cap V \bullet = \emptyset$.
If $M \xrightarrow{\sigma u} M'$ with $\sigma \in V^*$, then $M \xrightarrow{u \sigma} M'$

$$M \xrightarrow{v_1} \xrightarrow{v_2} \dots \xrightarrow{v_{n-1}} \xrightarrow{v_n} \xrightarrow{u} M'$$

Exchange lemma:

finite sequences (2)

Lemma: Let $V \subset T$ and $u \in T \setminus V$, with $\bullet u \cap V \bullet = \emptyset$.
If $M \xrightarrow{\sigma u} M'$ with $\sigma \in V^*$, then $M \xrightarrow{u \sigma} M'$

$$M \xrightarrow{v_1} \xrightarrow{v_2} \dots \xrightarrow{v_{n-1}} \xrightarrow{u} \xrightarrow{v_n} M'$$

Exchange lemma:

finite sequences (2)

Lemma: Let $V \subset T$ and $u \in T \setminus V$, with $\bullet u \cap V \bullet = \emptyset$.
If $M \xrightarrow{\sigma u} M'$ with $\sigma \in V^*$, then $M \xrightarrow{u \sigma} M'$

$$M \xrightarrow{u} \xrightarrow{v_1} \xrightarrow{v_2} \cdots \xrightarrow{v_{n-1}} \xrightarrow{v_n} M'$$

More on sequences: projection

Restriction: (also extraction / projection)
given $T' \subseteq T$ we inductively define $\sigma|_{T'}$ as:

$$\epsilon|_{T'} = \epsilon \quad (t\sigma)|_{T'} = \begin{cases} t(\sigma|_{T'}) & \text{if } t \in T' \\ \sigma|_{T'} & \text{if } t \notin T' \end{cases}$$

Example

$$(t_1 t_4 t_7 t_1 t_4 t_7) |_{\{t_1, t_4\}} = t_1 (t_4 t_7 t_1 t_4 t_7) |_{\{t_1, t_4\}}$$

$$= t_1 t_4 (t_7 t_1 t_4 t_7) |_{\{t_1, t_4\}}$$

$$= t_1 t_4 (t_1 t_4 t_7) |_{\{t_1, t_4\}}$$

$$= t_1 t_4 t_1 (t_4 t_7) |_{\{t_1, t_4\}}$$

$$= t_1 t_4 t_1 t_4 (t_7) |_{\{t_1, t_4\}}$$

$$= t_1 t_4 t_1 t_4 (t_7 \epsilon) |_{\{t_1, t_4\}}$$

$$= t_1 t_4 t_1 t_4 (\epsilon) |_{\{t_1, t_4\}}$$

$$= t_1 t_4 t_1 t_4 \epsilon$$

$$= t_1 t_4 t_1 t_4$$

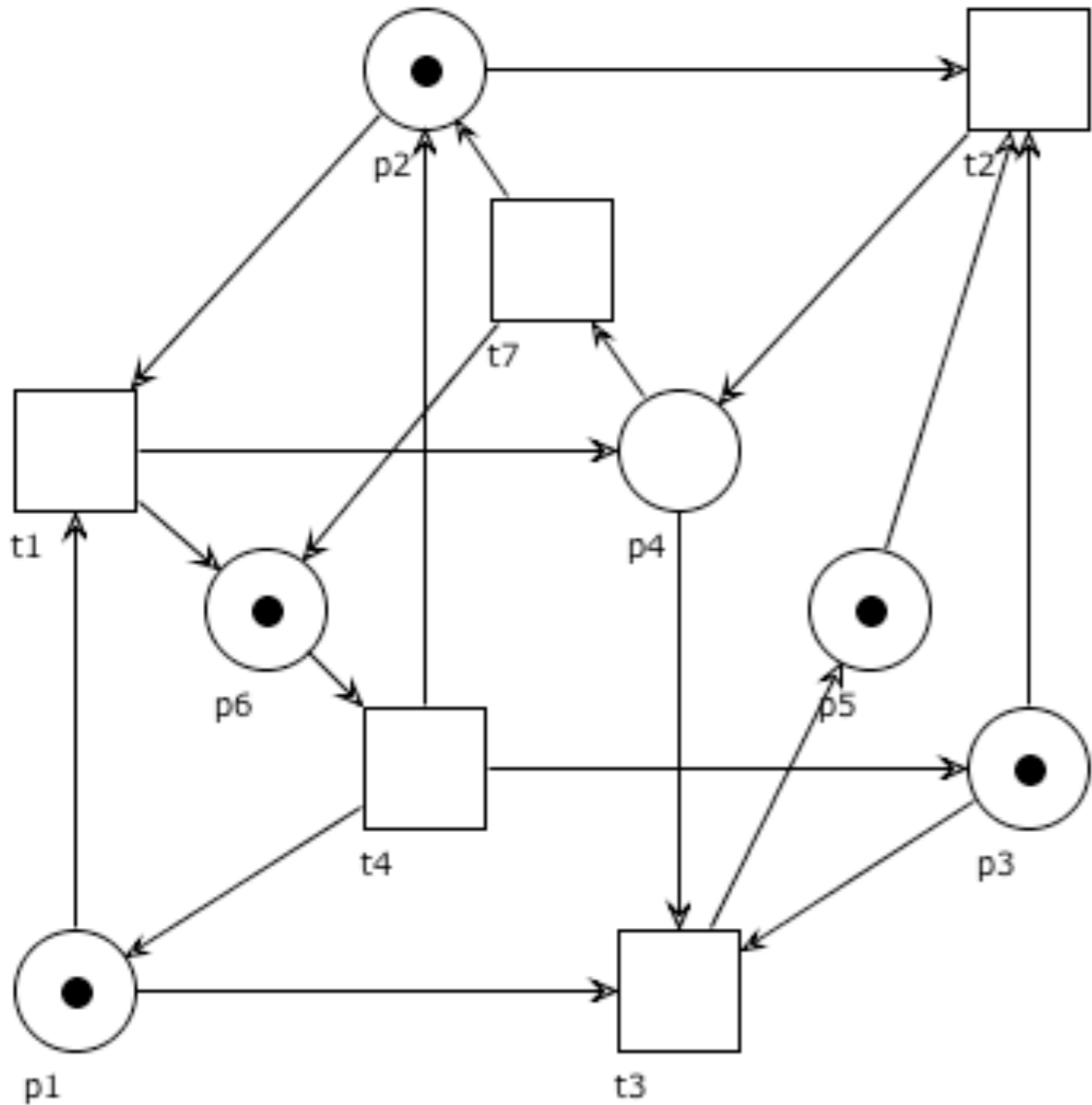

Exchange lemma:

finite sequences (3)

Lemma: Let $U, V \subset T$ and $U \cap V = \emptyset$, with $\bullet U \cap V \bullet = \emptyset$.

If $M \xrightarrow{\sigma} M'$ with $\sigma \in (U \cup V)^*$, then $M \xrightarrow{\sigma|_U \sigma|_V} M'$

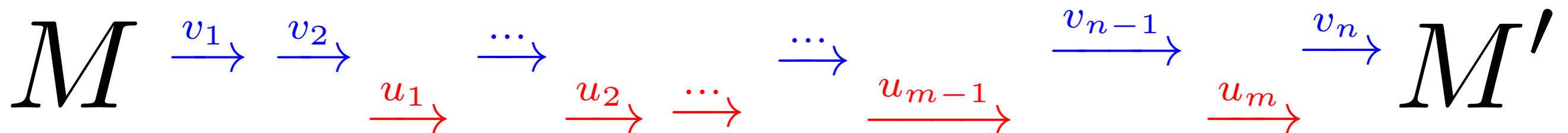

Exchange lemma:

finite sequences (3)

Lemma: Let $U, V \subset T$ and $U \cap V = \emptyset$, with $\bullet U \cap V \bullet = \emptyset$.

If $M \xrightarrow{\sigma} M'$ with $\sigma \in (U \cup V)^*$, then $M \xrightarrow{\sigma|_U \sigma|_V} M'$

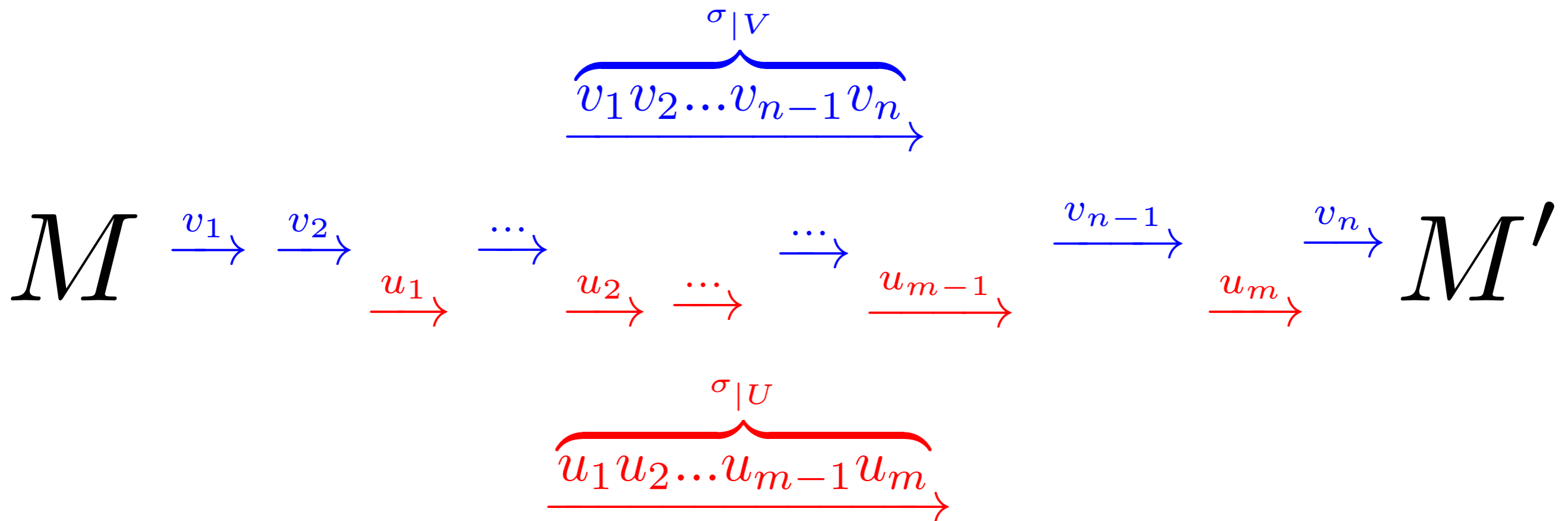

Exchange lemma:

finite sequences (3)

Lemma: Let $U, V \subset T$ and $U \cap V = \emptyset$, with $\bullet U \cap V \bullet = \emptyset$.

If $M \xrightarrow{\sigma} M'$ with $\sigma \in (U \cup V)^*$, then $M \xrightarrow{\sigma|_U \sigma|_V} M'$

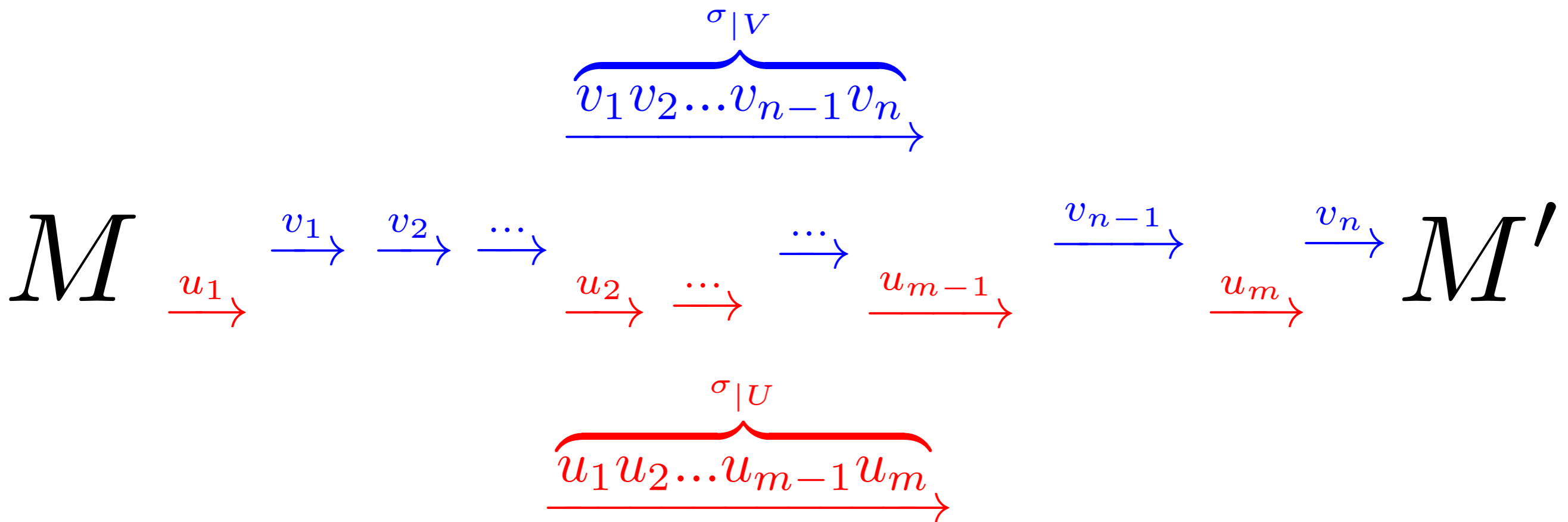

Exchange lemma:

finite sequences (3)

Lemma: Let $U, V \subset T$ and $U \cap V = \emptyset$, with $\bullet U \cap V \bullet = \emptyset$.

If $M \xrightarrow{\sigma} M'$ with $\sigma \in (U \cup V)^*$, then $M \xrightarrow{\sigma|_U \sigma|_V} M'$

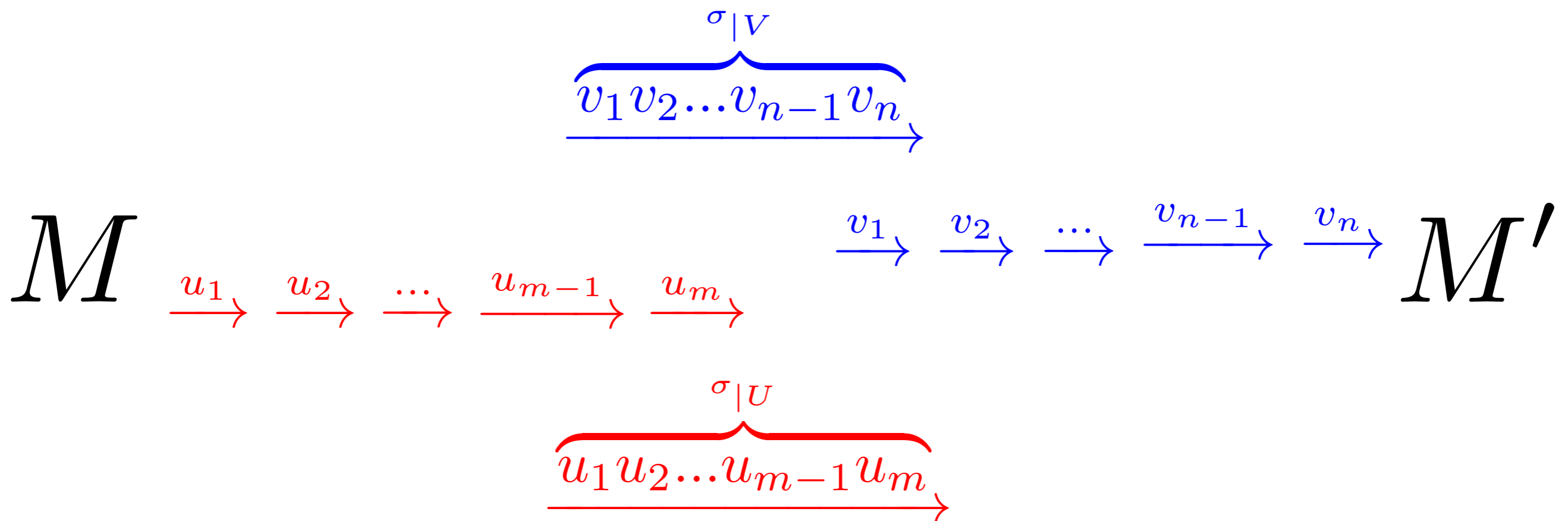

Exchange lemma:

finite sequences (3)

Lemma: Let $U, V \subset T$ and $U \cap V = \emptyset$, with $\bullet U \cap V \bullet = \emptyset$.

If $M \xrightarrow{\sigma} M'$ with $\sigma \in (U \cup V)^*$, then $M \xrightarrow{\sigma|_U \sigma|_V} M'$

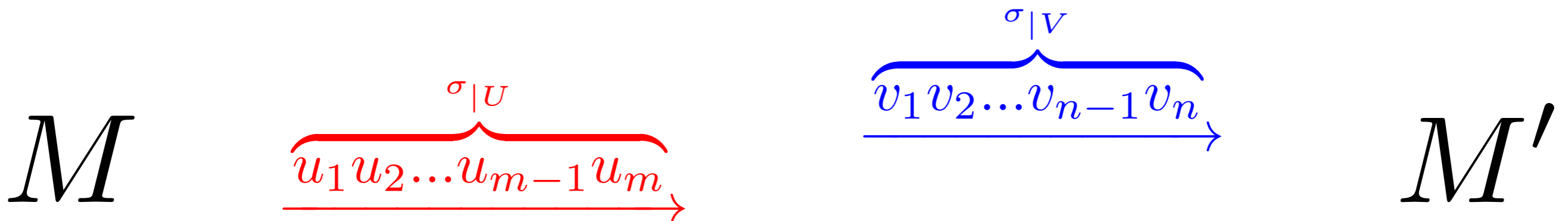

Notation A^ω

Given a set A we denote by A^ω
the set of infinite sequences of elements in A , i.e.:

$$A^\omega = \{ a_1 a_2 \cdots \mid a_1, a_2, \dots \in A \}$$

Exchange lemma:

infinite sequences (4)

Lemma: Let $U, V \subset T$ and $U \cap V = \emptyset$, with $\bullet U \cap V \bullet = \emptyset$.
If $M \xrightarrow{\sigma}$ with $\sigma \in (U \cup V)^\omega$ and $\sigma|_U \in U^*$, then $M \xrightarrow{\sigma|_U \sigma|_V}$

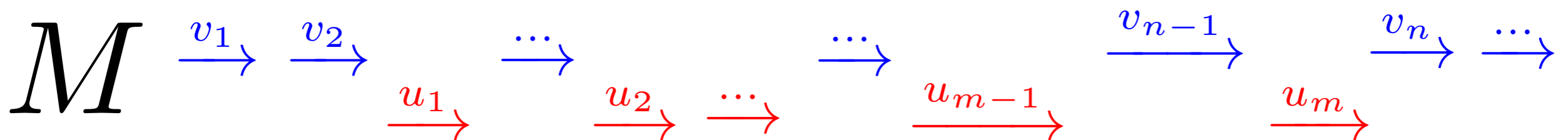

Exchange lemma: infinite sequences (4)

Lemma: Let $U, V \subset T$ and $U \cap V = \emptyset$, with $\bullet U \cap V \bullet = \emptyset$.
If $M \xrightarrow{\sigma}$ with $\sigma \in (U \cup V)^\omega$ and $\sigma|_U \in U^*$, then $M \xrightarrow{\sigma|_U \sigma|_V}$

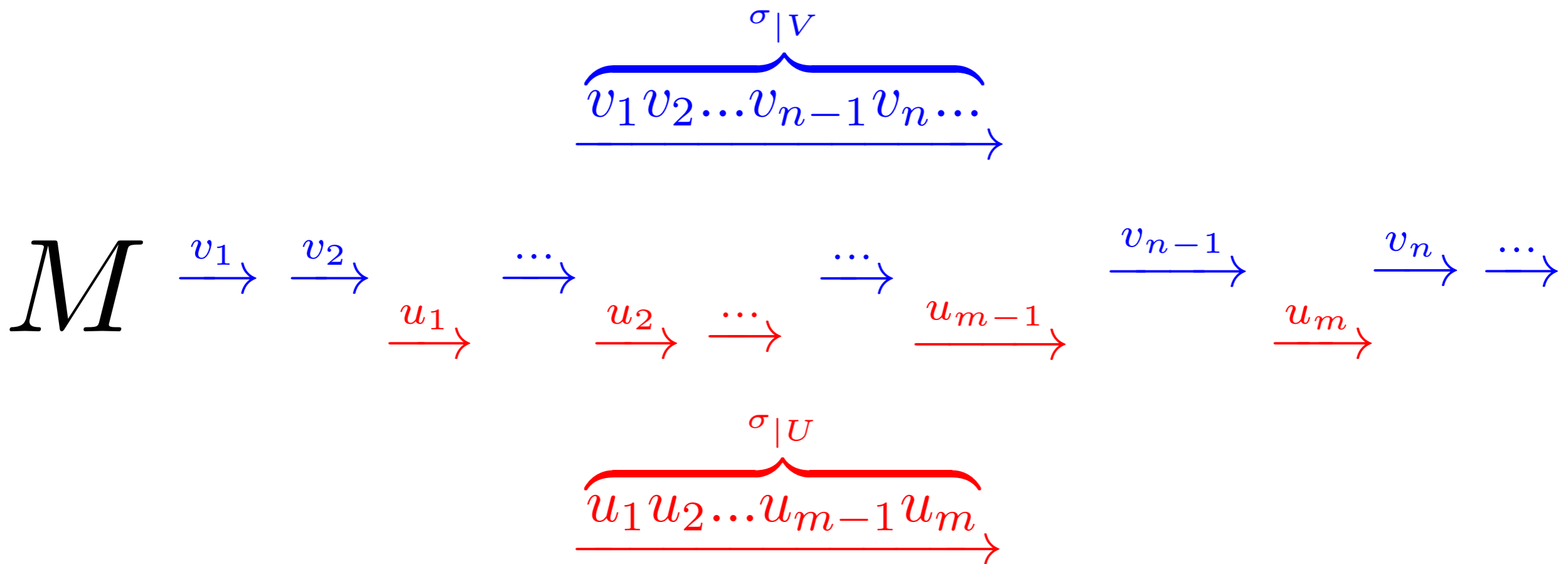

Exchange lemma: infinite sequences (4)

Lemma: Let $U, V \subset T$ and $U \cap V = \emptyset$, with $\bullet U \cap V \bullet = \emptyset$.
If $M \xrightarrow{\sigma}$ with $\sigma \in (U \cup V)^\omega$ and $\sigma|_U \in U^*$, then $M \xrightarrow{\sigma|_U \sigma|_V}$

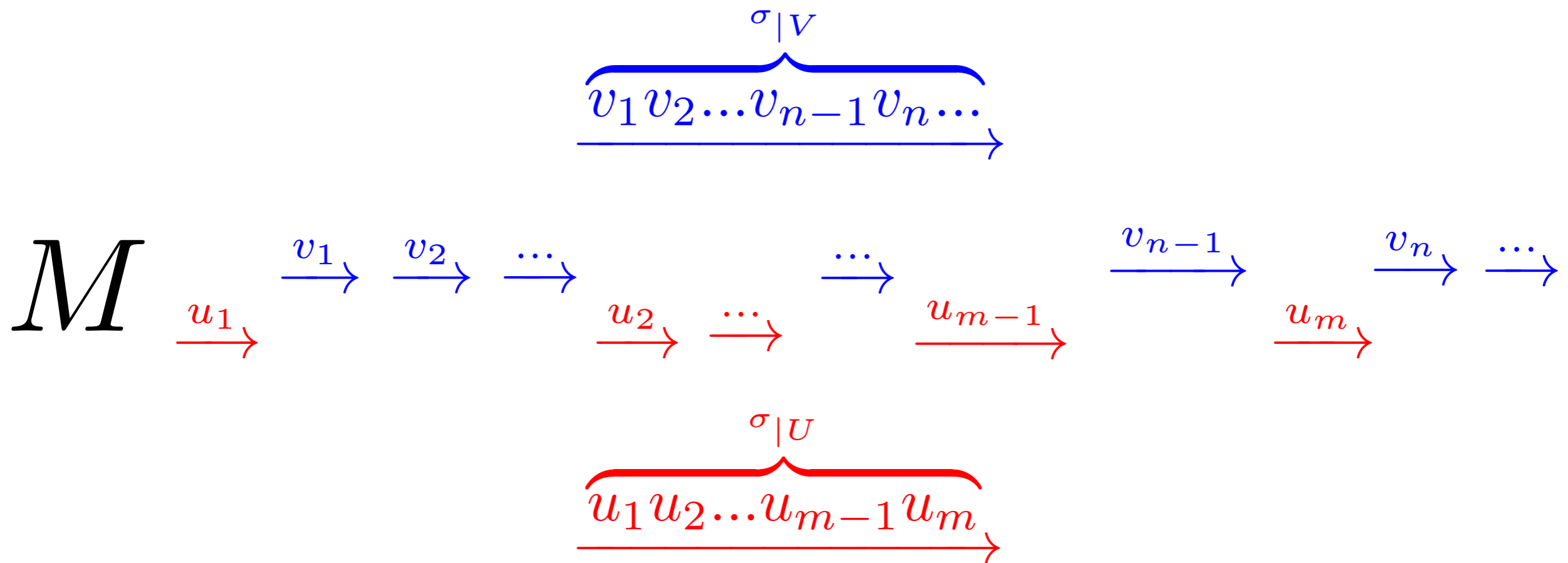

Exchange lemma: infinite sequences (4)

Lemma: Let $U, V \subset T$ and $U \cap V = \emptyset$, with $\bullet U \cap V \bullet = \emptyset$.
If $M \xrightarrow{\sigma}$ with $\sigma \in (U \cup V)^\omega$ and $\sigma|_U \in U^*$, then $M \xrightarrow{\sigma|_U \sigma|_V}$

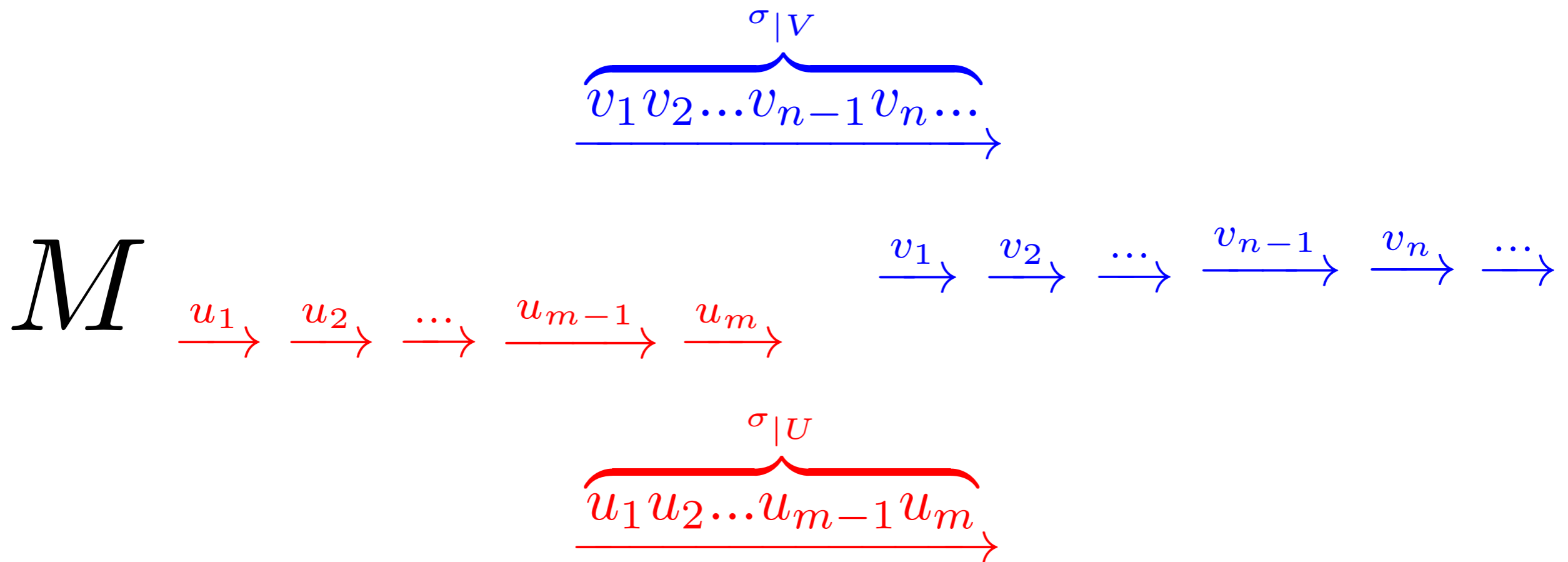

Exchange lemma: infinite sequences (4)

Lemma: Let $U, V \subset T$ and $U \cap V = \emptyset$, with $\bullet U \cap V \bullet = \emptyset$.
If $M \xrightarrow{\sigma}$ with $\sigma \in (U \cup V)^\omega$ and $\sigma|_U \in U^*$, then $M \xrightarrow{\sigma|_U \sigma|_V}$

$$M \quad \underbrace{u_1 u_2 \dots u_{m-1} u_m}_{\sigma|_U} \quad \underbrace{v_1 v_2 \dots v_{n-1} v_n \dots}_{\sigma|_V}$$

Exchange lemma: infinite sequences (5)

Lemma: Let $U, V \subset T$ and $U \cap V = \emptyset$, with $\bullet U \cap V \bullet = \emptyset$.
If $M \xrightarrow{\sigma}$ with $\sigma \in (U \cup V)^\omega$ and $\sigma|_U \in U^\omega$, then $M \xrightarrow{\sigma|_U}$

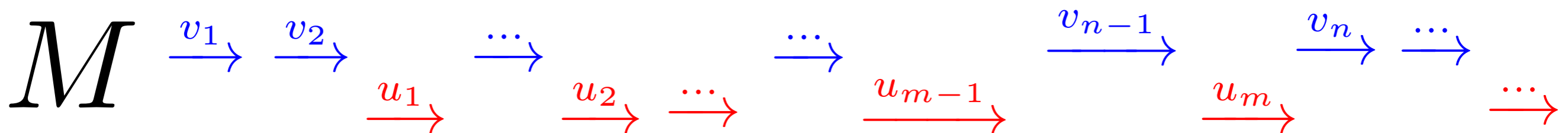

Exchange lemma: infinite sequences (5)

Lemma: Let $U, V \subset T$ and $U \cap V = \emptyset$, with $\bullet U \cap V \bullet = \emptyset$.
If $M \xrightarrow{\sigma}$ with $\sigma \in (U \cup V)^\omega$ and $\sigma|_U \in U^\omega$, then $M \xrightarrow{\sigma|_U}$

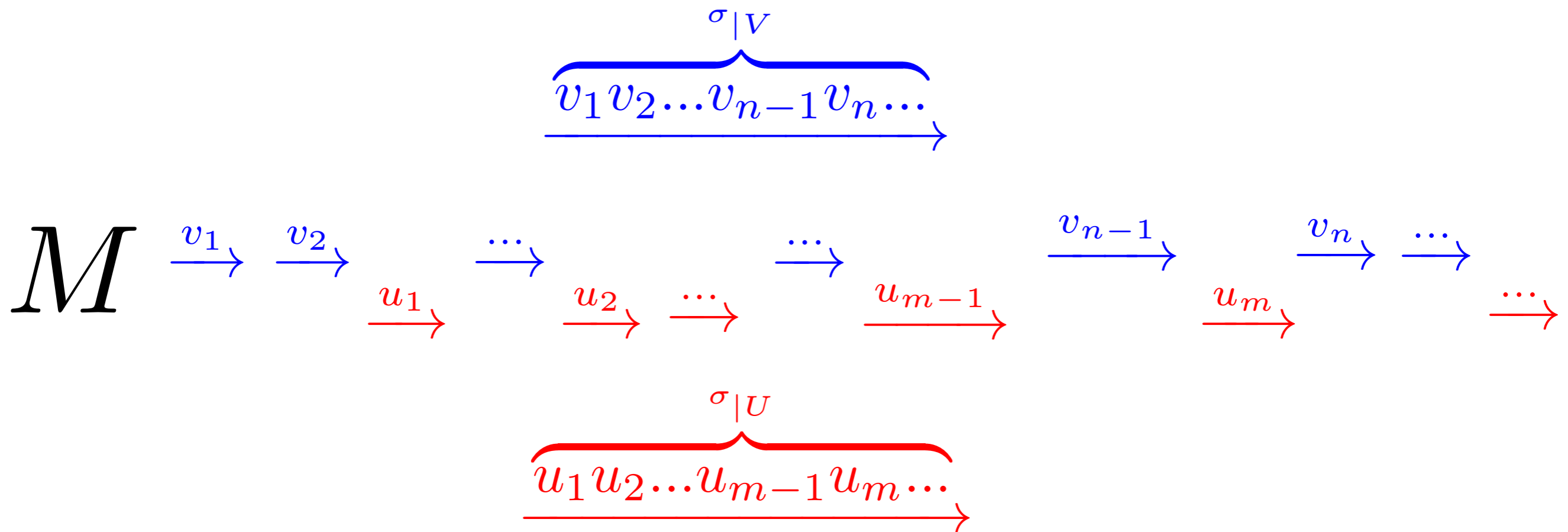

Exchange lemma: infinite sequences (5)

Lemma: Let $U, V \subset T$ and $U \cap V = \emptyset$, with $\bullet U \cap V \bullet = \emptyset$.
If $M \xrightarrow{\sigma}$ with $\sigma \in (U \cup V)^\omega$ and $\sigma|_U \in U^\omega$, then $M \xrightarrow{\sigma|_U}$

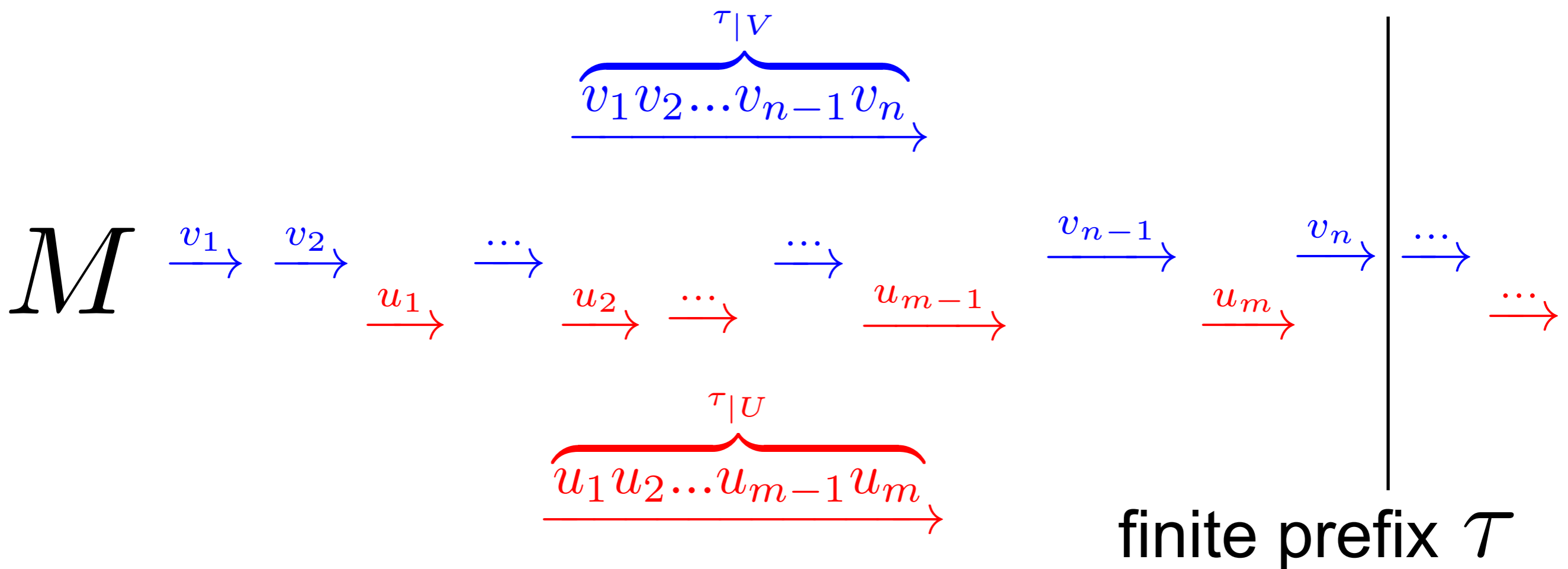

Exchange lemma: infinite sequences (5)

Lemma: Let $U, V \subset T$ and $U \cap V = \emptyset$, with $\bullet U \cap V \bullet = \emptyset$.
If $M \xrightarrow{\sigma}$ with $\sigma \in (U \cup V)^\omega$ and $\sigma|_U \in U^\omega$, then $M \xrightarrow{\sigma|_U}$

M

$\overbrace{u_1 u_2 \dots u_{m-1} u_m}^{\tau|_U}$

enabled

$\overbrace{v_1 v_2 \dots v_{n-1} v_n}^{\tau|_V}$

finite prefix

$\dots \rightarrow$
 $\dots \rightarrow$

Proofs of exchange
lemmas
(optional reading)

Exchange lemma: finite sequences (1)

Lemma: Let $u, v \in T$ with $\bullet u \cap v \bullet = \emptyset$.
If $M \xrightarrow{vu} M'$, then $M \xrightarrow{uv} M'$

Let $M \xrightarrow{v} K \xrightarrow{u} M'$.

Clearly $M' = \underbrace{K - \bullet u}_{K'} + u \bullet$, with $K' = K - \bullet u$.

Since $\bullet u \cap v \bullet = \emptyset$, then: $M'' \xrightarrow{v} K'$ with $M'' = M - \bullet u$

Therefore:

$$M = M'' + \bullet u \xrightarrow{u} M'' + u \bullet \xrightarrow{v} K' + u \bullet = M'$$

Exchange lemma: finite sequences (1)

Lemma: Let $u, v \in T$ with $\bullet u \cap v \bullet = \emptyset$.

If $M \xrightarrow{vu} M'$, then $M \xrightarrow{uv} M'$

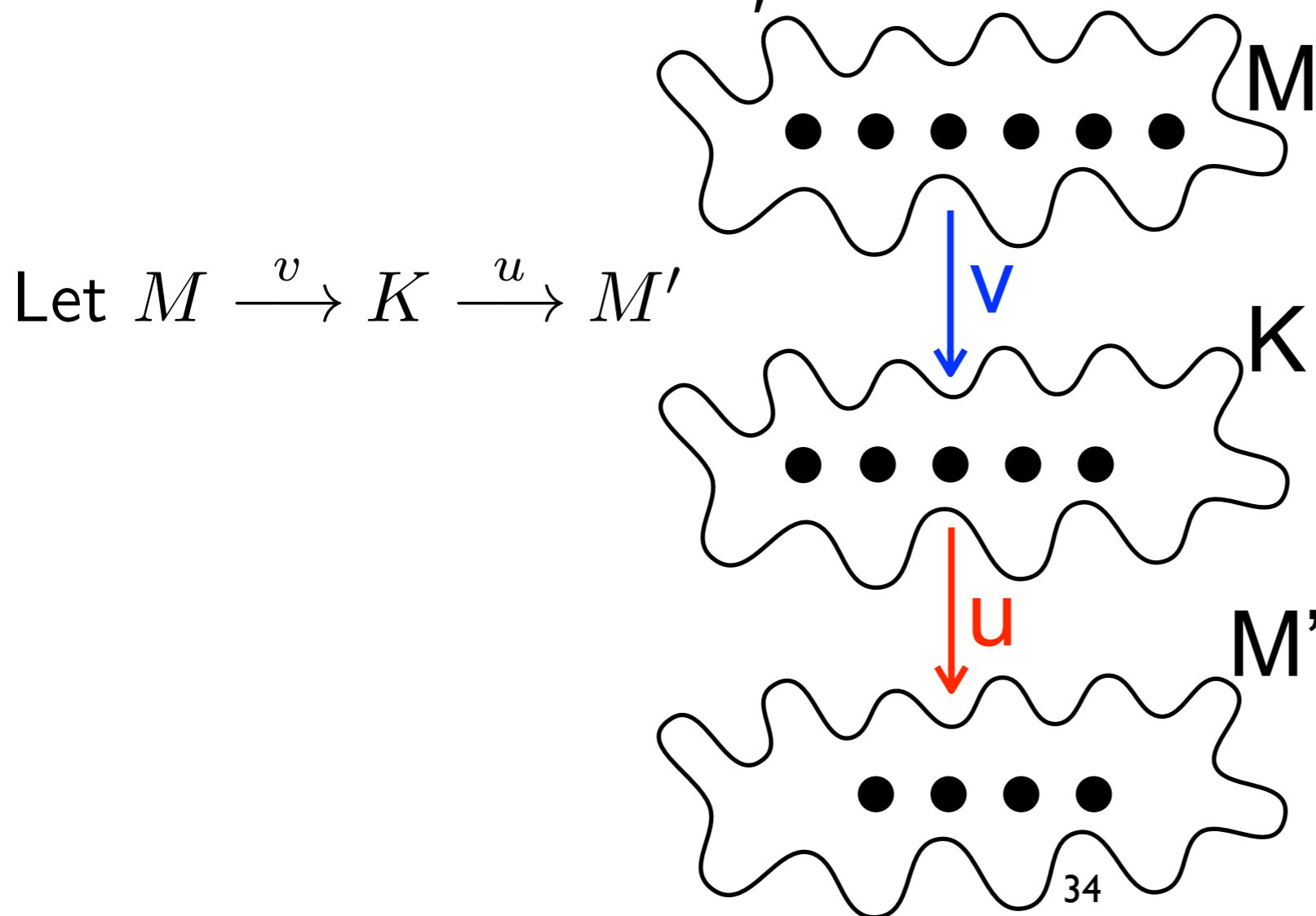

Exchange lemma: finite sequences (1)

Lemma: Let $u, v \in T$ with $\bullet u \cap v \bullet = \emptyset$.

If $M \xrightarrow{vu} M'$, then $M \xrightarrow{uv} M'$

Let $M \xrightarrow{v} K \xrightarrow{u} M'$ and $K' = K - \bullet u$.

pre-set of u

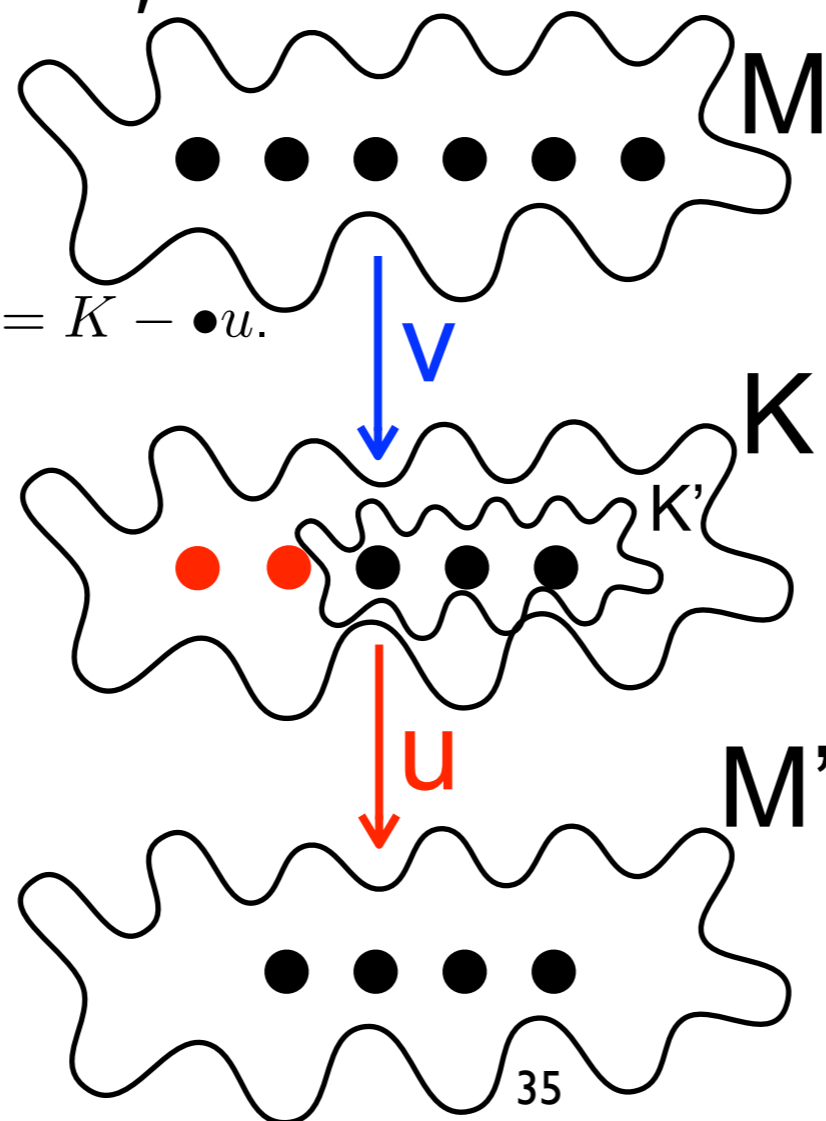

Exchange lemma:

finite sequences (1)

Lemma: Let $u, v \in T$ with $\bullet u \cap v \bullet = \emptyset$.

If $M \xrightarrow{vu} M'$, then $M \xrightarrow{uv} M'$

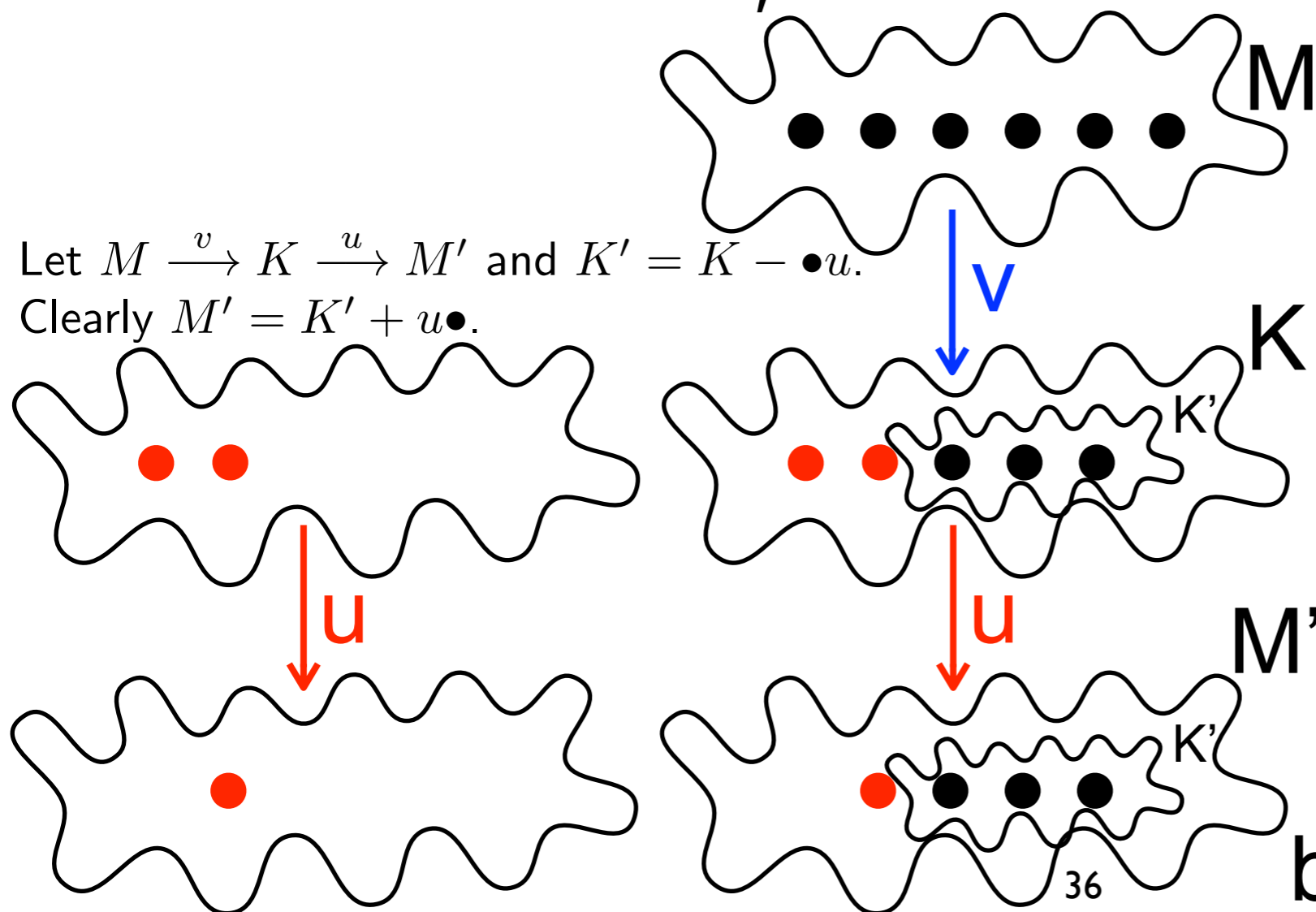

K' is preserved
by the firing of u

Exchange lemma:

finite sequences (1)

Lemma: Let $u, v \in T$ with $\bullet u \cap v \bullet = \emptyset$.

If $M \xrightarrow{vu} M'$, then $M \xrightarrow{uv} M'$

preserved by
the firing of v

Let $M \xrightarrow{v} K \xrightarrow{u} M'$ and $K' = K - \bullet u$.
Clearly $M' = K' + u \bullet$.

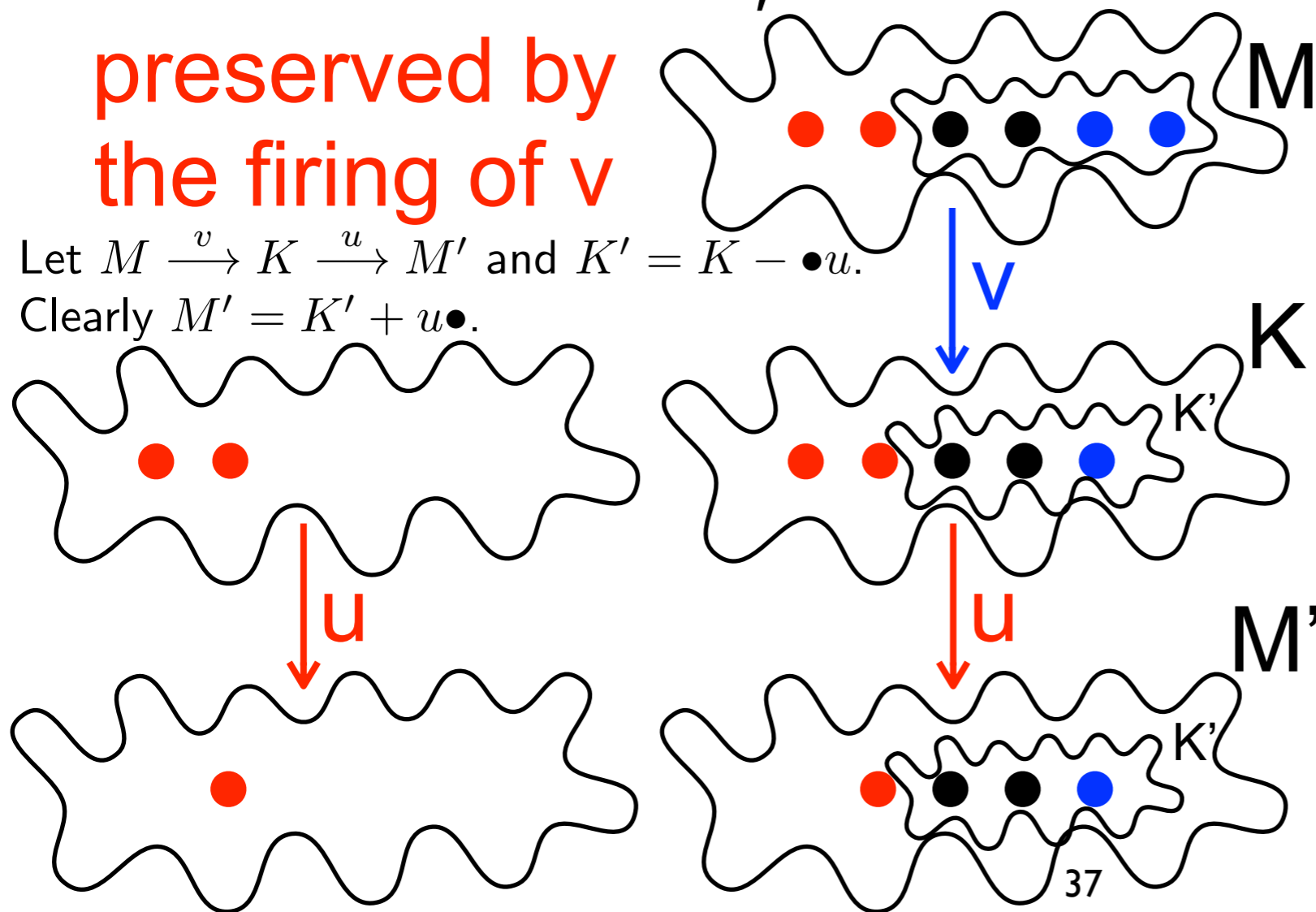

Since $\bullet u \cap v \bullet = \emptyset$

Exchange lemma: finite sequences (1)

Lemma: Let $u, v \in T$ with $\bullet u \cap v \bullet = \emptyset$.

If $M \xrightarrow{vu} M'$, then $M \xrightarrow{uv} M'$

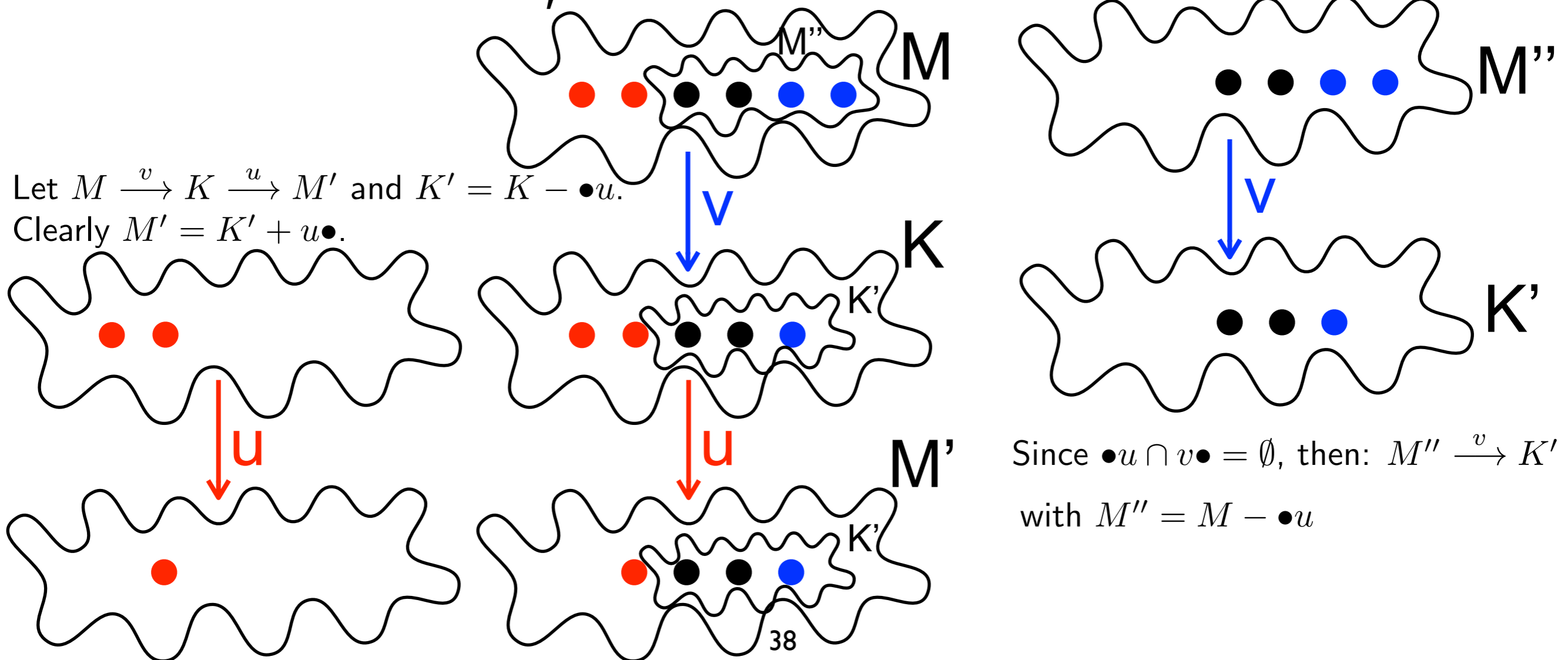

Exchange lemma: finite sequences (1)

Lemma: Let $u, v \in T$ with $\bullet u \cap v \bullet = \emptyset$.

If $M \xrightarrow{vu} M'$, then $M \xrightarrow{uv} M'$

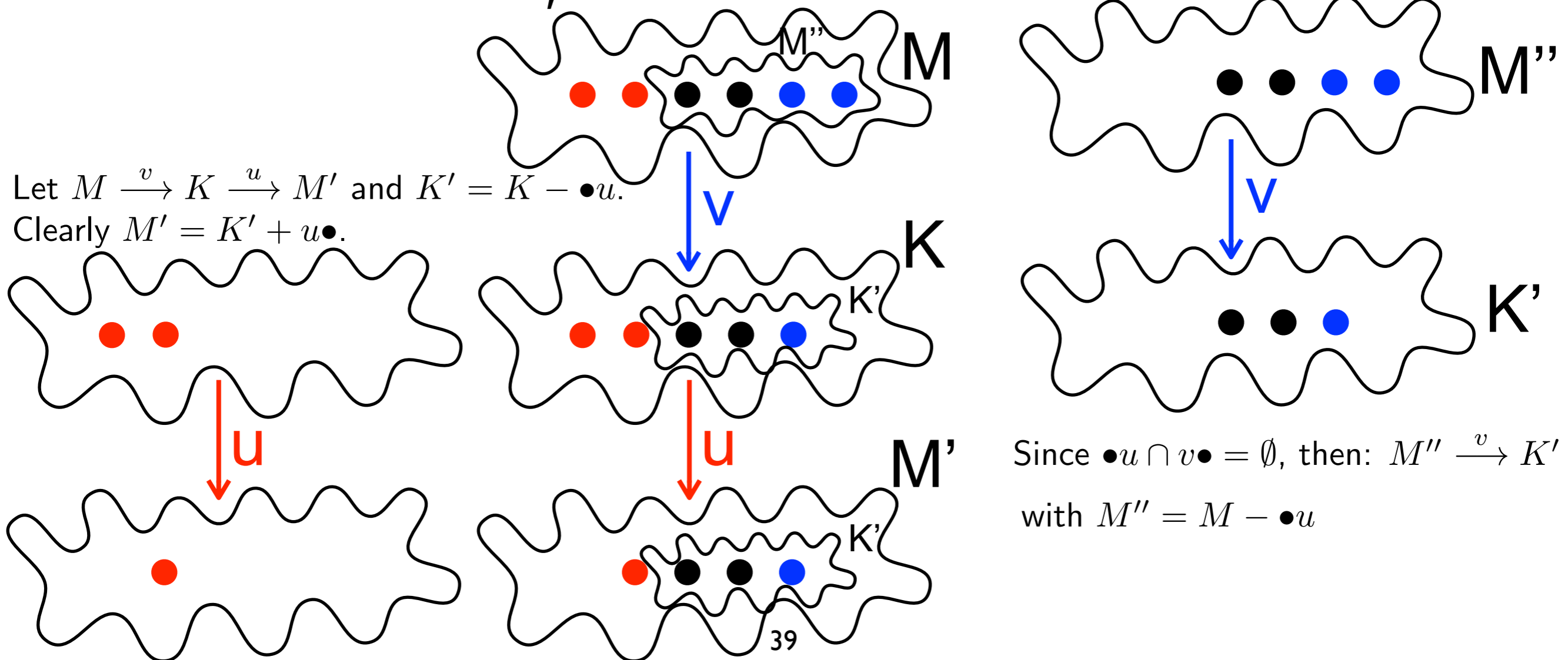

Exchange lemma:

finite sequences (1)

Lemma: Let $u, v \in T$ with $\bullet u \cap v \bullet = \emptyset$.

If $M \xrightarrow{vu} M'$, then $M \xrightarrow{uv} M'$

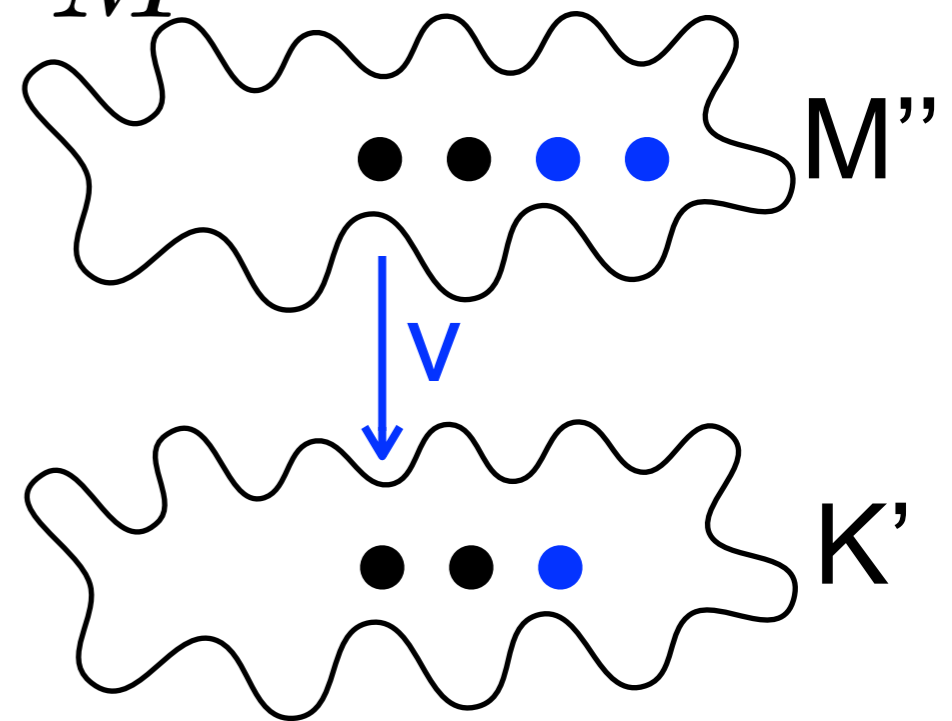
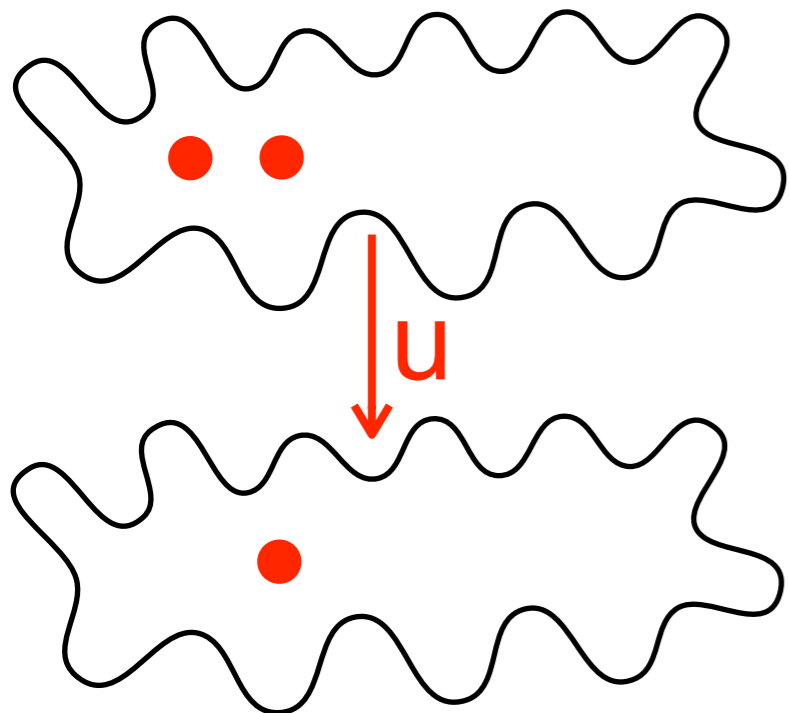

Exchange lemma: finite sequences (1)

Lemma: Let $u, v \in T$ with $\bullet u \cap v \bullet = \emptyset$.

If $M \xrightarrow{vu} M'$, then $M \xrightarrow{uv} M'$

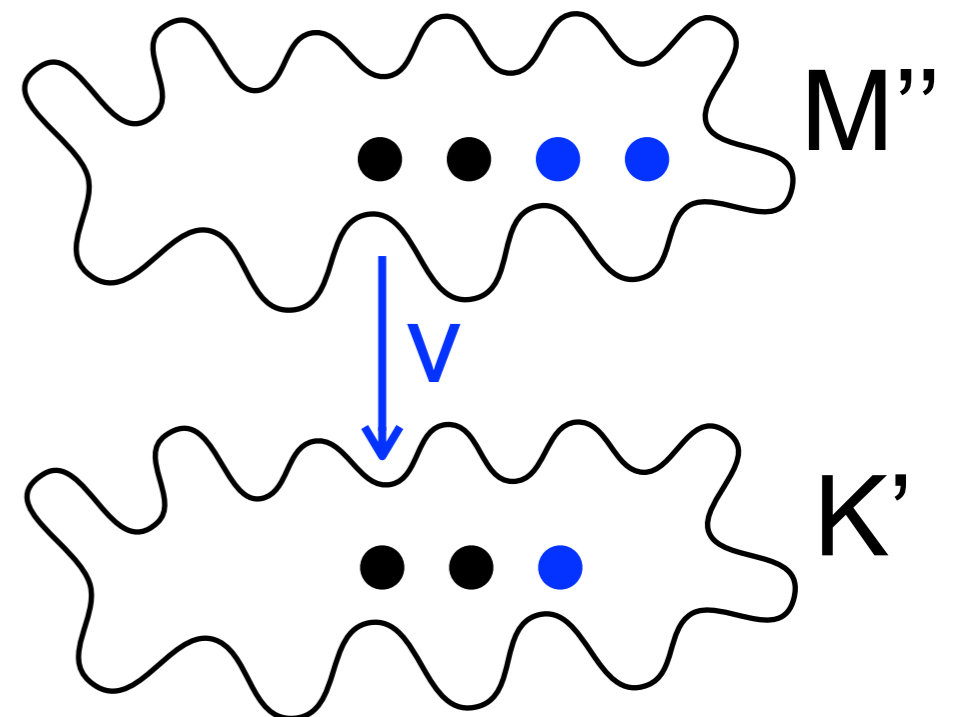
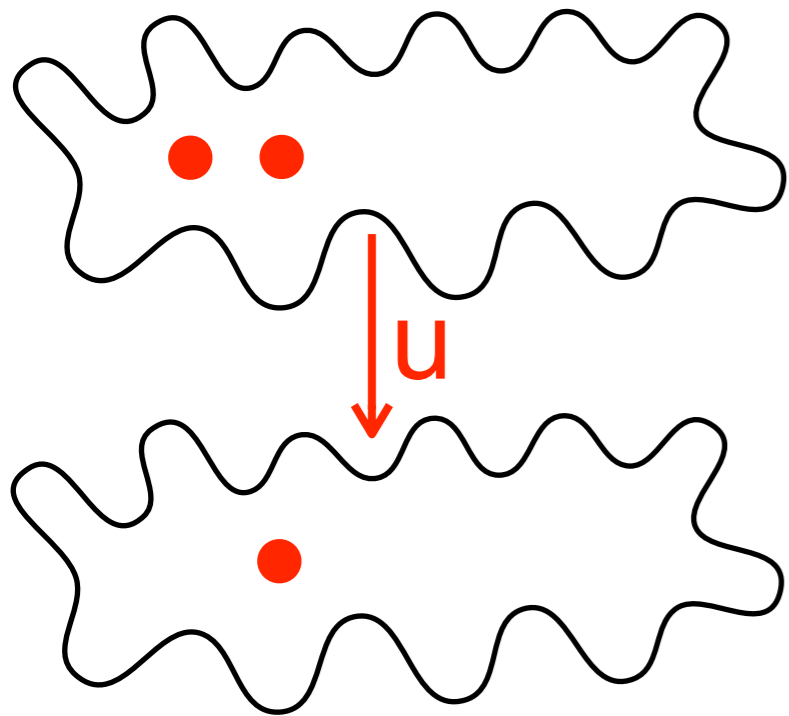

Exchange lemma: finite sequences (1)

Lemma: Let $u, v \in T$ with $\bullet u \cap v \bullet = \emptyset$.

If $M \xrightarrow{vu} M'$, then $M \xrightarrow{uv} M'$

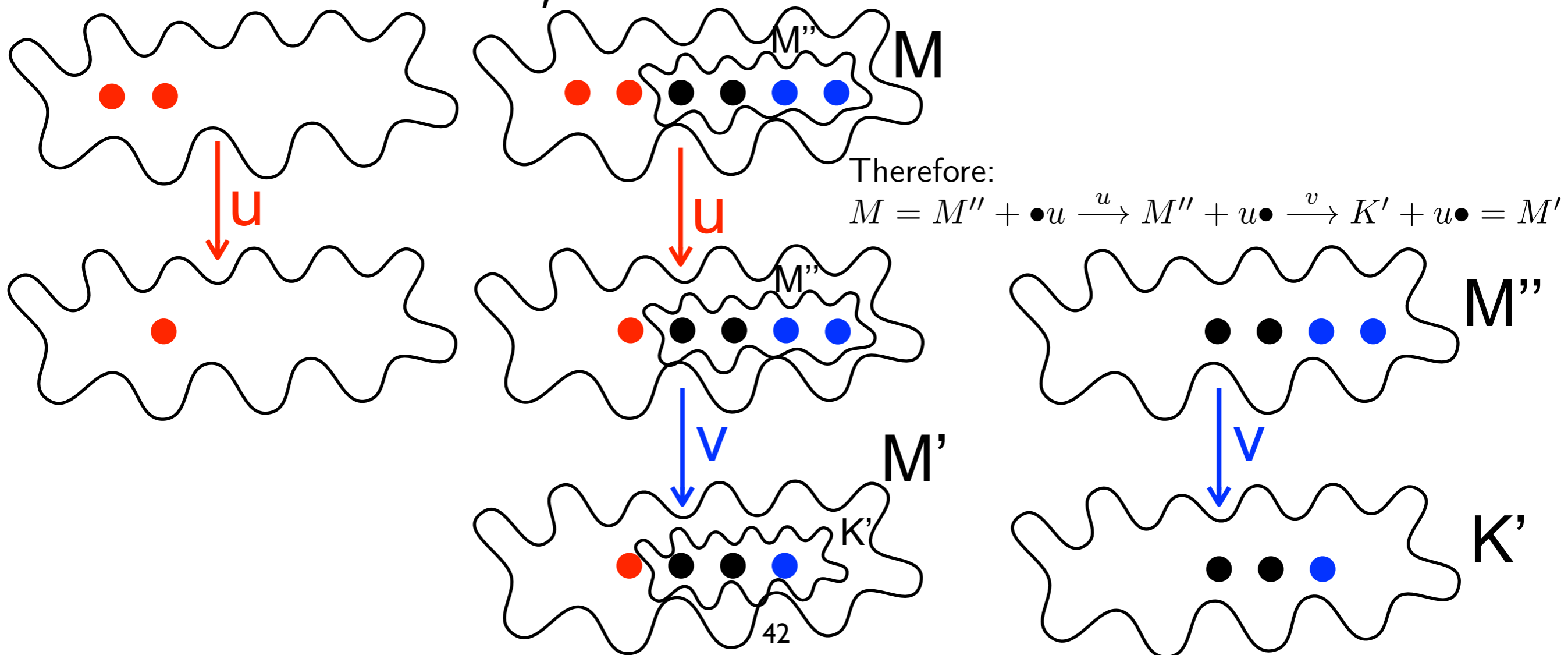

Exchange lemma: finite sequences (2)

Lemma: Let $V \subset T$ and $u \in T \setminus V$, with $\bullet u \cap V \bullet = \emptyset$.
If $M \xrightarrow{\sigma u} M'$ with $\sigma \in V^*$, then $M \xrightarrow{u\sigma} M'$

The proof is by induction on the length of σ

base ($\sigma = \epsilon$): trivially $M \xrightarrow{u} M'$

induction ($\sigma = \sigma'v$ for some $\sigma' \in V^*$ and $v \in V$):

Let $M \xrightarrow{\sigma'} M'' \xrightarrow{vu} M'$. Note that $\bullet u \cap v \bullet = \emptyset$

By exchange lemma 1: $M \xrightarrow{\sigma'} M'' \xrightarrow{uv} M'$.

Let $M \xrightarrow{\sigma' u} M''' \xrightarrow{v} M'$.

By inductive hypothesis: $M \xrightarrow{u\sigma'} M''' \xrightarrow{v} M'$

Thus, $M \xrightarrow{u\sigma} M'$

Exchange lemma: finite sequences (3)

Lemma: Let $U, V \subset T$ and $U \cap V = \emptyset$, with $\bullet U \cap V \bullet = \emptyset$.

If $M \xrightarrow{\sigma} M'$ with $\sigma \in (U \cup V)^*$, then $M \xrightarrow{\sigma|_U \sigma|_V} M'$

The proof is by induction on the length of $\sigma|_U$

base ($\sigma|_U = \epsilon$): trivially $\sigma|_V = \sigma$

induction ($\sigma|_U = u\sigma'$ for some $u \in U$ and $\sigma' \in U^*$):

Let $M \xrightarrow{\sigma_0} \xrightarrow{u} \xrightarrow{\sigma_1} M'$, with $\sigma = \sigma_0 u \sigma_1$ and $\sigma_0 \in V^*$.

Note that $\sigma' = (\sigma_1)|_U$ and $\bullet u \cap V \bullet = \emptyset$

By exchange lemma 2: $M \xrightarrow{u} \xrightarrow{\sigma_0} \xrightarrow{\sigma_1} M'$.

Note that $(\sigma_0 \sigma_1)|_U = (\sigma_1)|_U = \sigma'$ and $(\sigma_0 \sigma_1)|_V = \sigma|_V$.

By inductive hypothesis: $M \xrightarrow{u} \xrightarrow{\sigma'} \xrightarrow{\sigma|_V} M'$

Since $\sigma|_U = u\sigma'$, we conclude that $M \xrightarrow{\sigma|_U} \xrightarrow{\sigma|_V} M'$

Exchange lemma: infinite sequences (4)

Lemma: Let $U, V \subset T$ and $U \cap V = \emptyset$, with $\bullet U \cap V \bullet = \emptyset$.
If $M \xrightarrow{\sigma}$ with $\sigma \in (U \cup V)^\omega$ and $\sigma|_U \in U^*$, then $M \xrightarrow{\sigma|_U \sigma|_V}$

Let $\sigma = \sigma' \sigma''$ with $\sigma'|_U = \sigma|_U$ and $\sigma''|_V = \sigma''$

(i.e., only transitions in V appears in σ'').

Such sequences exist because $\sigma|_U$ is assumed to be finite.

Let M' be such that $M \xrightarrow{\sigma'} M' \xrightarrow{\sigma''}$.

By Exchange Lemma (3) applied to σ' we have:

$$M \xrightarrow{\sigma'|_U \sigma'|_V} M' \xrightarrow{\sigma''}$$

We conclude by observing that:

$$\sigma|_U = \sigma'|_U \quad \text{and} \quad \sigma|_V = \sigma'|_V \sigma''$$

Exchange lemma: infinite sequences (5)

Lemma: Let $U, V \subset T$ and $U \cap V = \emptyset$, with $\bullet U \cap V \bullet = \emptyset$.
If $M \xrightarrow{\sigma}$ with $\sigma \in (U \cup V)^\omega$ and $\sigma|_U \in U^\omega$, then $M \xrightarrow{\sigma|_U}$

To prove that $M \xrightarrow{\sigma|_U}$ it suffices to show that every finite prefix of $\sigma|_U$ is enabled at M .

Take any finite prefix τ' of $\sigma|_U$ and a corresponding finite prefix τ of σ such that $\tau|_U = \tau'$.

Clearly $M \xrightarrow{\tau} M'$ for some suitable M' .

By Exchange Lemma (3), then $M \xrightarrow{\tau|_U \tau|_V} M'$, i.e.:
 M enables $\tau|_U = \tau'$.

Proofs of theorems on strong connectedness (optional reading)

Strong connectedness theorem

Theorem: If a weakly connected system is live and bounded then it is strongly connected

Since the system is live and bounded, by a previous corollary: (see Lecture 11) exists $M \in [M_0\rangle$ and σ such that $M \xrightarrow{\sigma} M$ and all transitions in T occur in σ .

Take any arc $x \rightarrow y$ in F :

we need to show that there is a path from y to x using arcs of F .

We distinguish two cases:

1. $x \in P$ and $y \in T$
2. $x \in T$ and $y \in P$

Strong connectedness theorem (case 1)

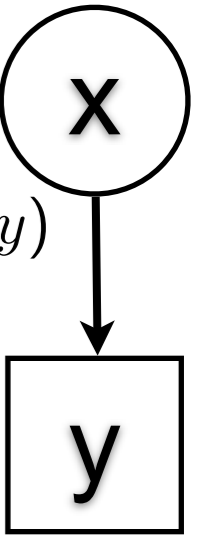

Let $V = \{v \in T \mid y \rightarrow^* v\}$ and $U = T \setminus V$. (V is the set of transitions reachable from y)

Note that U and V are disjoint and that $\bullet U \cap V \bullet = \emptyset$.

(to see this, suppose $q \in \bullet U \cap V \bullet$ then $v \rightarrow q \rightarrow u$ for some $v \in V$ and $u \in U$, but then $u \in V$, which is impossible because $U = T \setminus V$)

By the Exchange Lemma (3), there exists M' with $M \xrightarrow{\sigma|_U} M' \xrightarrow{\sigma|_V} M$

We claim that $M \xrightarrow{\sigma|_V} M$.

(we want to find a path from y to x)

- if $\sigma|_U = \epsilon$ (i.e., σ does not contain any transition in U), then $\sigma|_V = \sigma$.
- otherwise ($\sigma|_U \neq \epsilon$), we can apply the Exchange Lemma (5) to $M \xrightarrow{\sigma\sigma\cdots}$ to get $M \xrightarrow{(\sigma\sigma\cdots)|_U} M$, i.e., $M \xrightarrow{\sigma|_U\sigma|_U\cdots} M$.

Since $\sigma|_U$ can occur infinitely often from M , then $M' \supseteq M$.

By the Boundedness Lemma $M' = M$ and $M \xrightarrow{\sigma|_V} M$.

Since $y \in V$, y occurs in $\sigma|_V$ and $y \in x \bullet$, then $(y$ subtracts a token from $x)$
 there must be some transition v that occurs in $\sigma|_V$ such that $v \in \bullet x$. $(v$ adds a token to $x)$

Since $v \in V$, there is a path $y \rightarrow^* v$.

We can extend this path by the arc (v, x) to get a path $y \rightarrow^* x$.

Strong connectedness theorem (case 2)

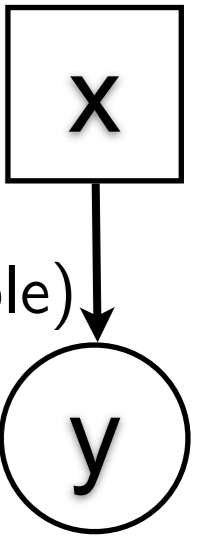

(U is the set of transitions from which x is reachable)

Let $U = \{ u \in T \mid u \rightarrow^* x \}$ and $V = T \setminus U$.

Note that U and V are disjoint and that $\bullet U \cap V \bullet = \emptyset$.

(to see this, suppose $q \in \bullet U \cap V \bullet$ then $v \rightarrow q \rightarrow u$ for some $v \in V$ and $u \in U$, but then $v \in U$, which is impossible because $V = T \setminus U$)

(we want to find a path from y to x)

By the Exchange Lemma (3), there exists M' with $M \xrightarrow{\sigma|_U} M' \xrightarrow{\sigma|_V} M$

By the Exchange Lemma (5) applied to $M \xrightarrow{\sigma\sigma\cdots}$

we get $M \xrightarrow{(\sigma\sigma\cdots)|_U} M$, i.e., $M \xrightarrow{\sigma|_U\sigma|_U\cdots} M$.

Since $\sigma|_U$ can occur infinitely often from M , then $M' \supseteq M$.

By the Boundedness Lemma $M' = M$ and $M \xrightarrow{\sigma|_U} M$.

Since $x \in U$, x occurs in $\sigma|_U$ and $x \in \bullet y$, then $(x$ adds a token to $y)$
there must be some transition u that occurs in $\sigma|_U$ such that $u \in y \bullet$.

$(u$ subtracts a token from $y)$

Since $u \in U$, there is a path $u \rightarrow^* x$.

We can extend this path by the arc (y, u) to get a path $y \rightarrow^* x$.

Strong connectedness via invariants

Theorem: If a weakly connected net has
a positive S-invariant I and a positive T-invariant J
then it is strongly connected

Take any arc $x \rightarrow y$ in F :

we need to show that there is a path from y to x using arcs of F .

We distinguish two cases:

1. $x \in P$ and $y \in T$
2. $x \in T$ and $y \in P$

Strong connectedness via invariants: case (1)

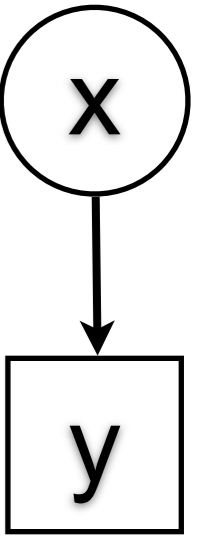

Let $V = \{ v \in T \mid y \rightarrow^* v \}$ and define:

$$J'(t) = \begin{cases} \mathbf{J}(t) & \text{if } t \in V \\ 0 & \text{otherwise} \end{cases} \quad (V \text{ is the set of transitions reachable from } y)$$

(we want to find a path from y to x)

Take $p \in P$:

- if $J'(u) = 0$ for all $u \in \bullet p$, then:

$$0 = \sum_{u \in \bullet p} J'(u) \leq \sum_{t \in p^\bullet} J'(t)$$

(because J' has no negative entries).

- otherwise, assume that $J'(u) = \mathbf{J}(u) > 0$ for some $u \in \bullet p$, i.e., $y \rightarrow^* u \rightarrow p$. Then, for any $t \in p^\bullet$: $y \rightarrow^* t$ and $J'(t) = \mathbf{J}(t) > 0$. So:

$$0 < \sum_{u \in \bullet p} J'(u) \leq \sum_{u \in \bullet p} \mathbf{J}(u) = \sum_{t \in p^\bullet} \mathbf{J}(t) = \sum_{t \in p^\bullet} J'(t)$$

Strong connectedness via invariants: case (1)

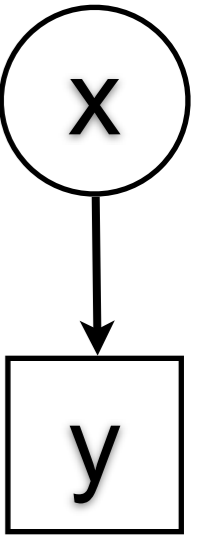

In both cases:
$$\sum_{u \in \bullet p} J'(u) \leq \sum_{t \in p \bullet} J'(t)$$

(we want to find a path from y to x)

Then:
$$(\mathbf{N} \cdot J')(p) = \sum_{u \in \bullet p} J'(u) - \sum_{t \in p \bullet} J'(t) \leq 0$$
 for any $p \in P$,

i.e., $\mathbf{N} \cdot J'$ has no positive entries.

Since \mathbf{I} is an S-invariant: $\mathbf{I} \cdot (\mathbf{N} \cdot J') = (\mathbf{I} \cdot \mathbf{N}) \cdot J' = 0$

and since \mathbf{I} is positive, $\mathbf{N} \cdot J' = \mathbf{0}$, i.e., J' is a T-invariant. Hence:

$$\sum_{t \in \bullet x} J'(t) = \sum_{t \in x \bullet} J'(t) \geq J'(y) = \mathbf{J}(y) > 0$$

So there exists $v \in \bullet x$ with $J'(v) > 0$, which means $v \in V$, i.e., $y \rightarrow^* v$.
Since $v \in \bullet x$, then $y \rightarrow^* x$.

Strong connectedness via invariants: case (2)

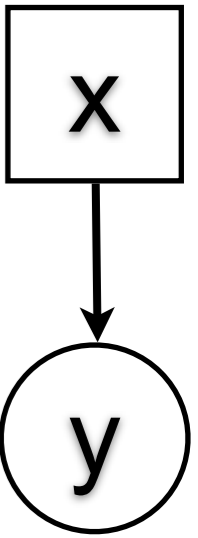

(we want to find a path from y to x)

Take $N' = (T, P, F)$

(i.e., invert the roles of places and transitions).

N'

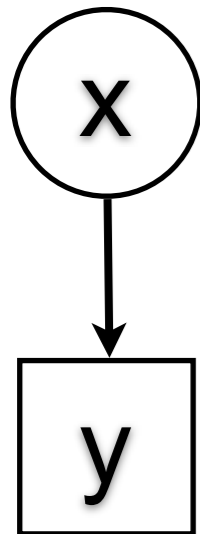

Then, $N' = -N^T$ (where N^T is the transposed of N)

I is a positive T-invariant of N' .

J is a positive S-invariant of N' .

By case (1), N' contains a path from y to x .

So, N contains a path from y to x .