

Business Processes Modelling

MPB (6 cfu, 295AA)

Roberto Bruni

<http://www.di.unipi.it/~bruni>

14 - Analysis of WF nets

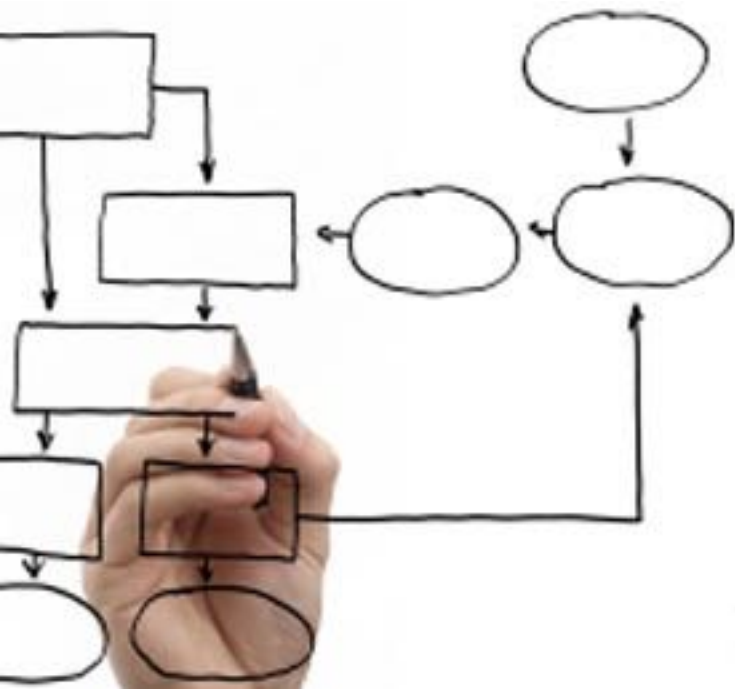

Object



We study suitable soundness properties
of Workflow nets

WF nets as business processes

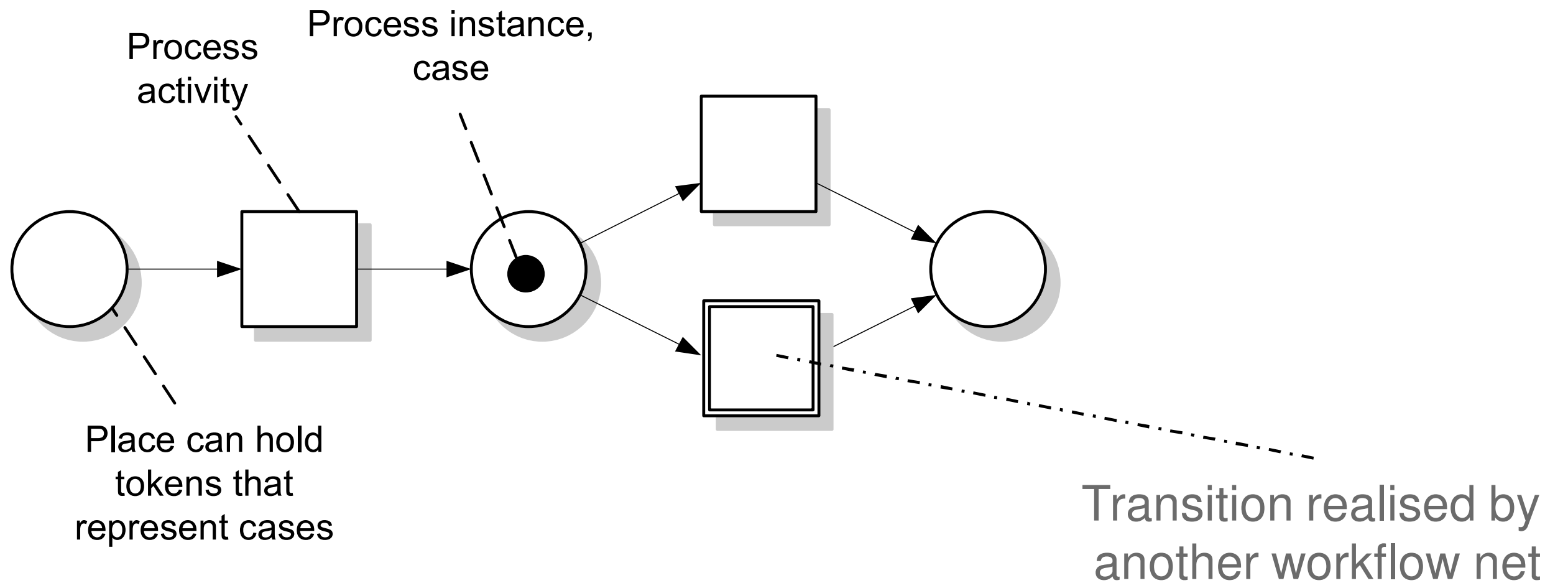

Structural analysis

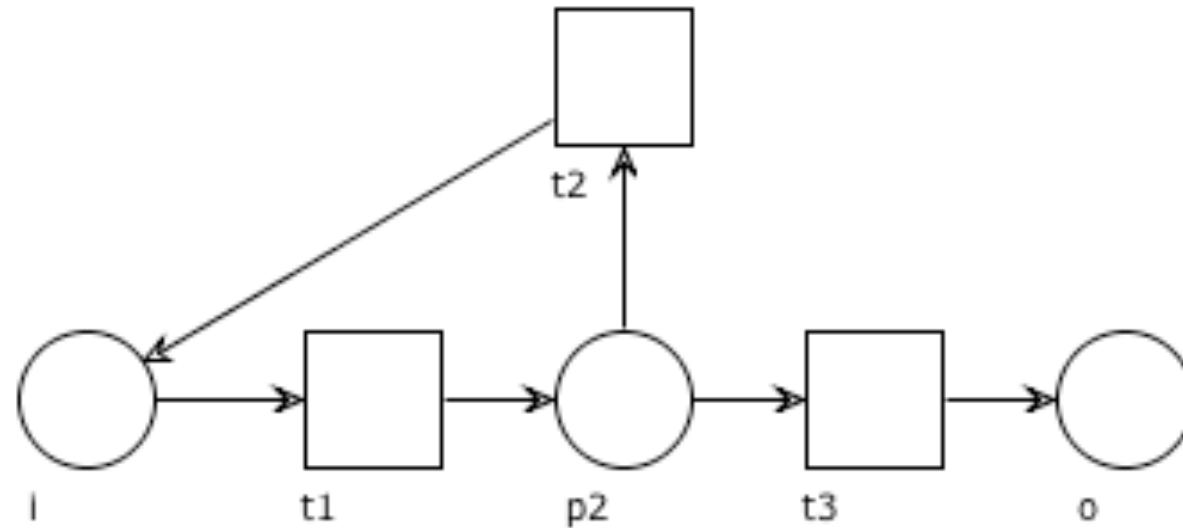

No distinguished entry / exit point

no entry: when should the case start?

no exit: when should the case end?

not a workflow net!

Structural analysis

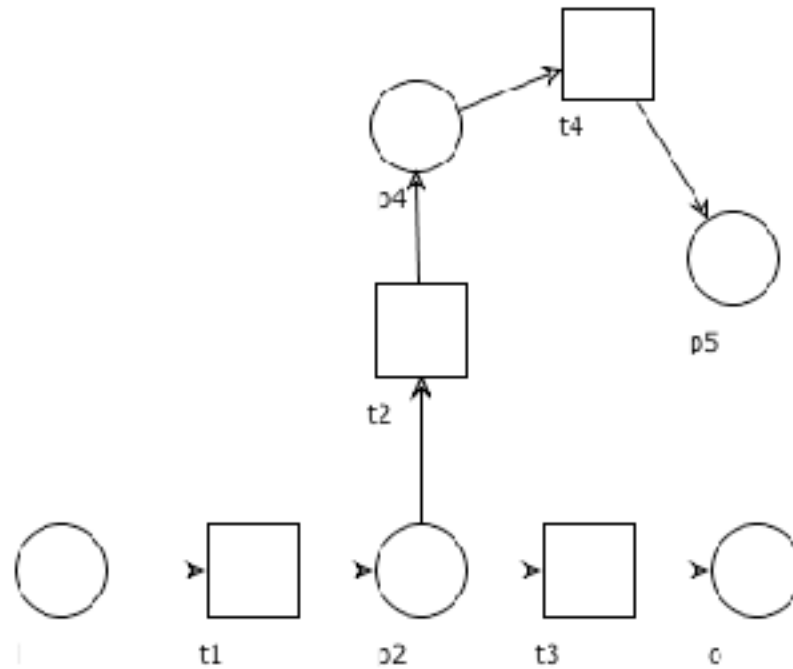

Multiple entry / exit points

multiple entries: when should the case start?

multiple exit: when should the case end?

not a workflow net!

Structural analysis

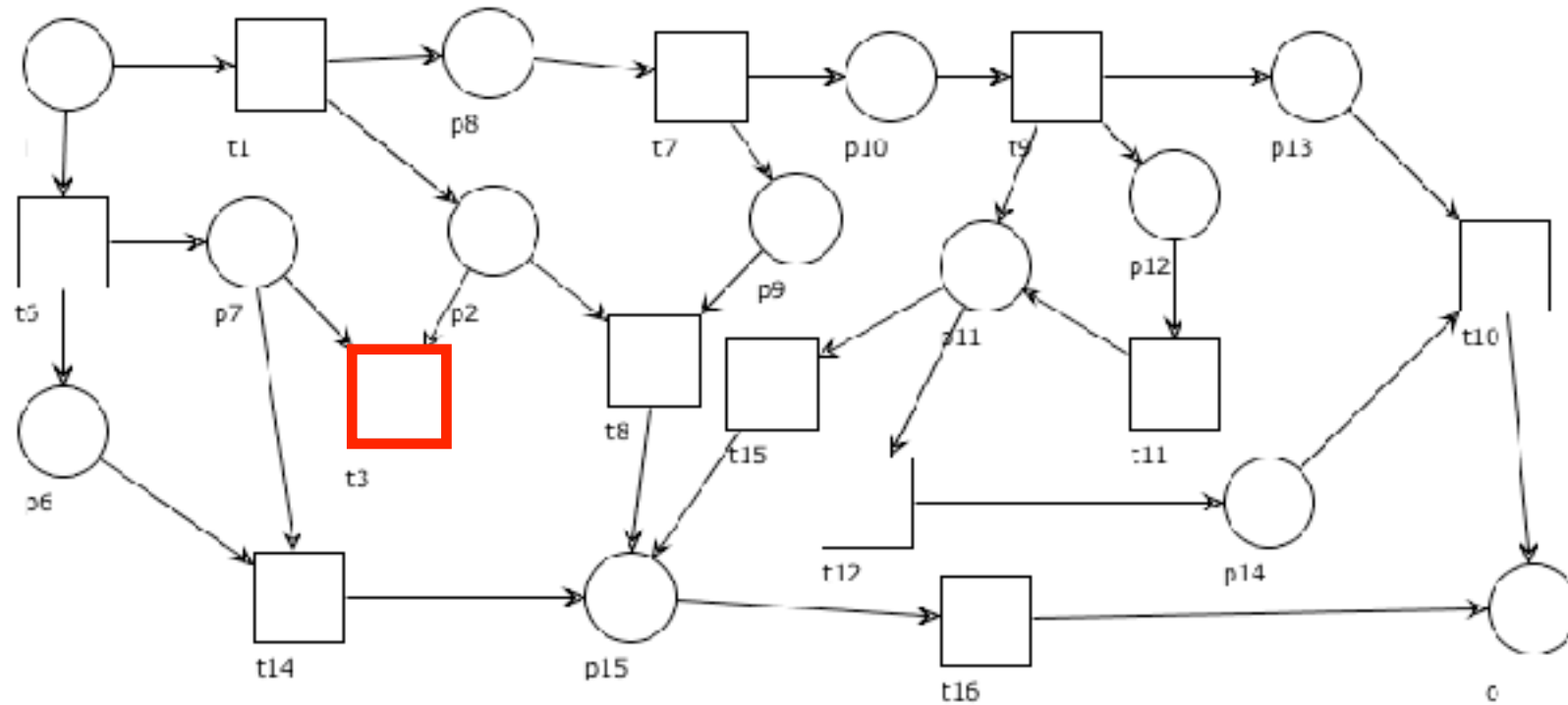

Tasks t without incoming and/or outgoing arcs

no input: when should t be carried out?

no output: t does not contribute to case completion

not a workflow net!

Structural analysis

Wrong decorations of transitions

split with only one outgoing arc

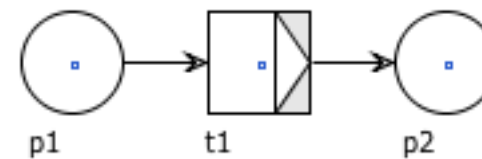
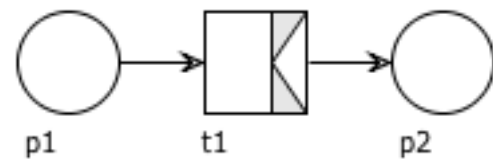

join with only one incoming arc

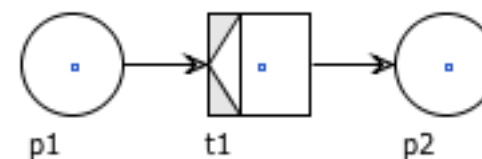
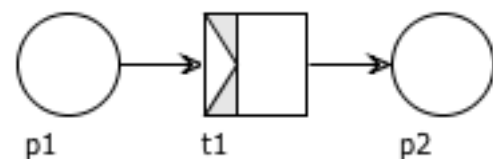

left to designer responsibility

Activity analysis

Dead tasks

Tasks that can never be carried out

Each transitions lies on a path from i to o: not sufficient

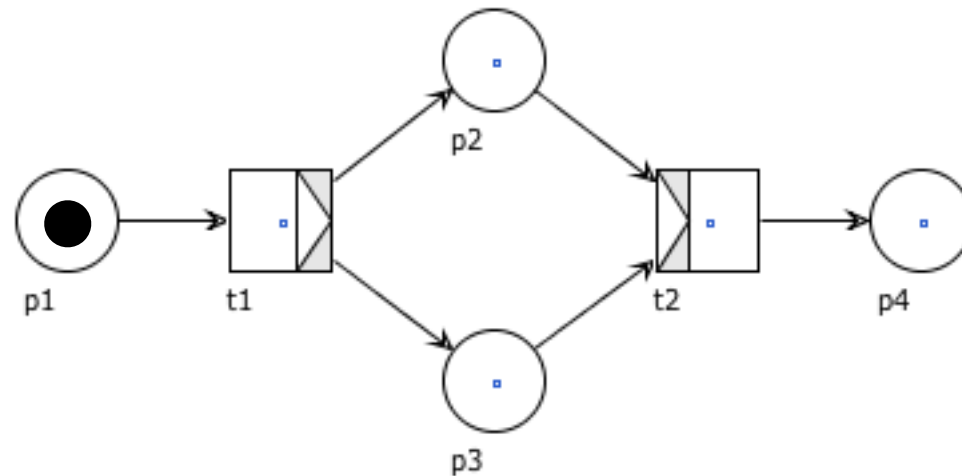

Activity analysis

Dead tasks

Tasks that can never be carried out

Each transitions lies on a path from i to o: not sufficient

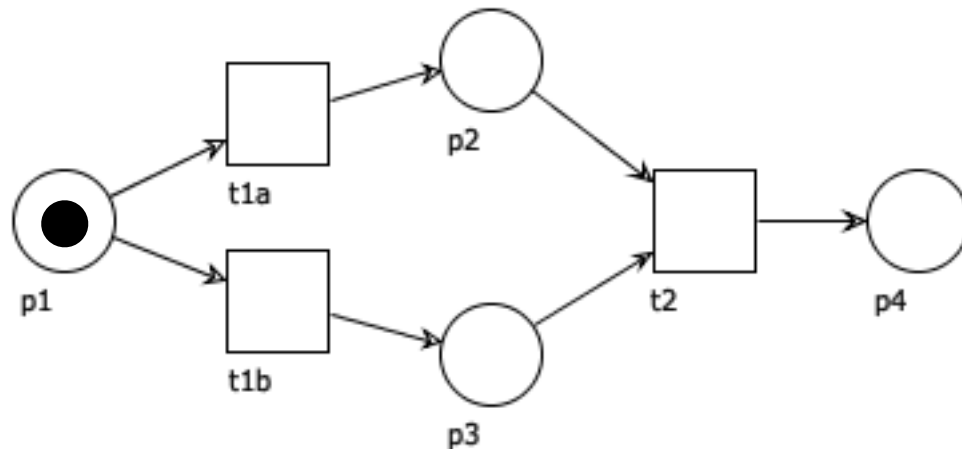

can arise in workflow nets

Net analysis

Deadlock

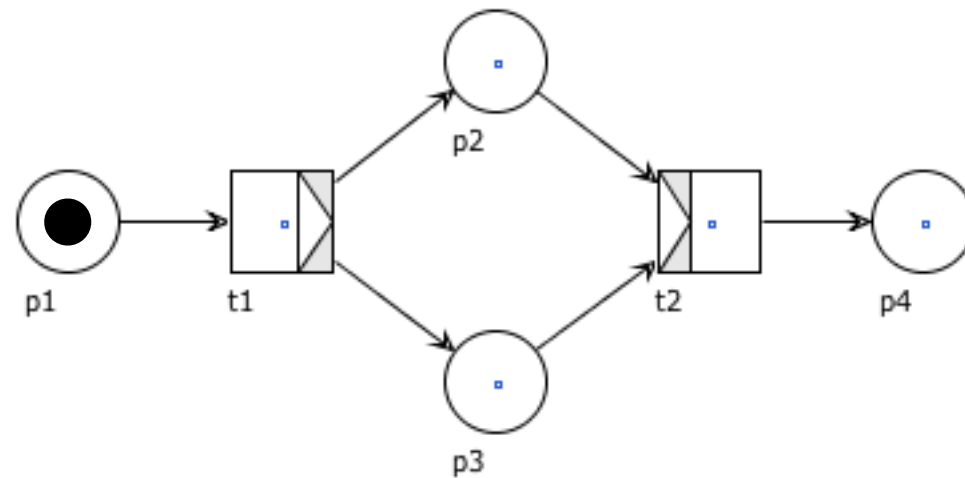

a case blocks without coming to an end
can arise in workflow nets

Token analysis

Some tokens left in the net after case completion

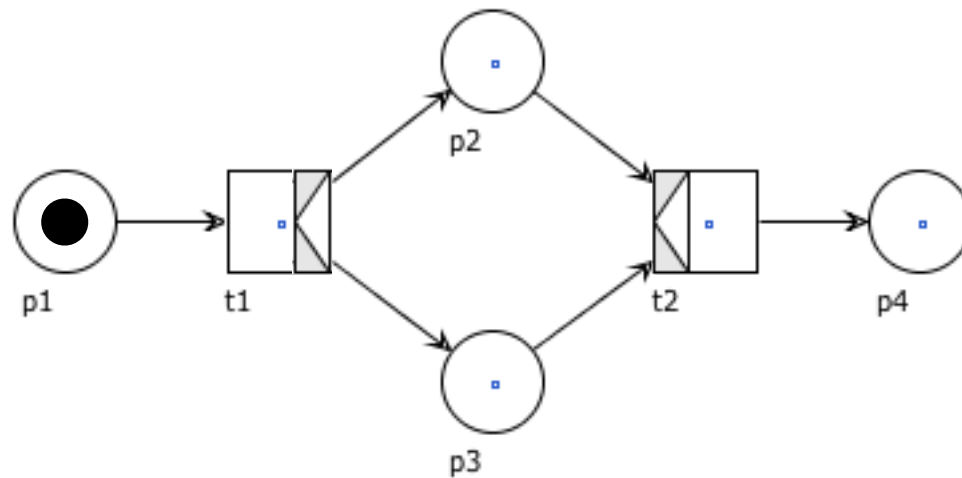

Token analysis

Some tokens left in the net after case completion

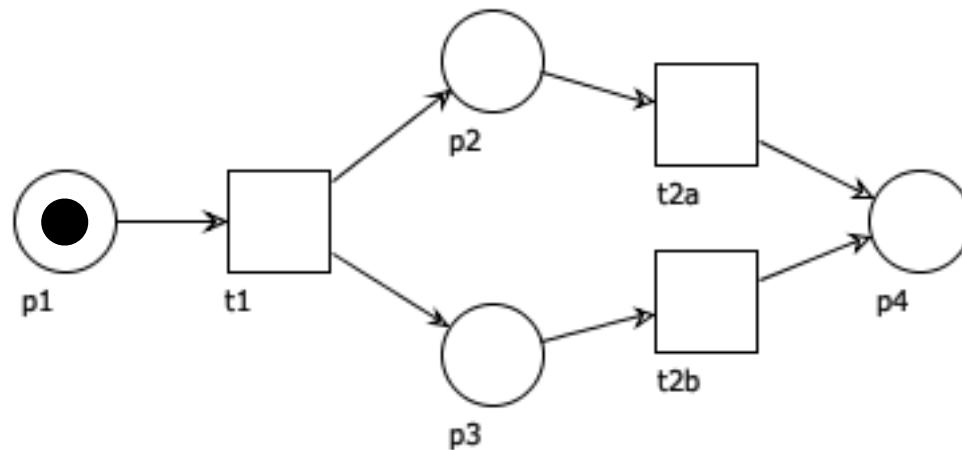

(when a token is in the final place the case should end)

can arise in workflow nets

Activity analysis

If tokens are left in the net after case completion
then
activities may still take place after case completion

it is a (worse) consequence of the previous flaw
can arise in workflow nets

Token analysis

More than one token reach the end place

it can be a consequence of the previous flaws
can arise in workflow nets

Question time

Do you see any problem in the workflow net below?

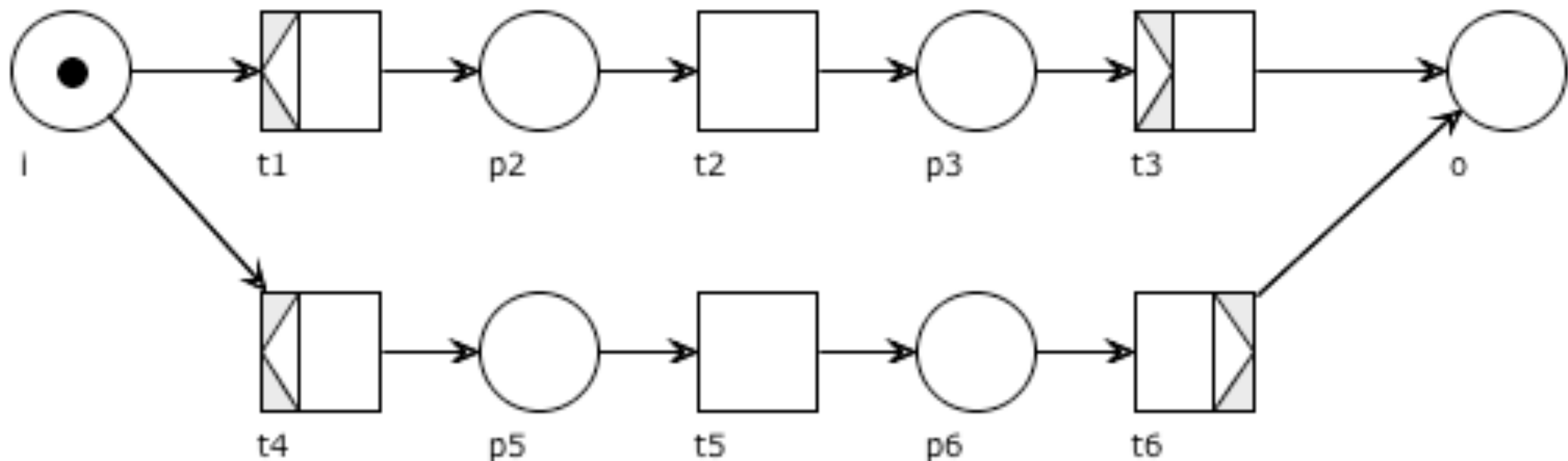

Question time

Do you see any problem in the net below?

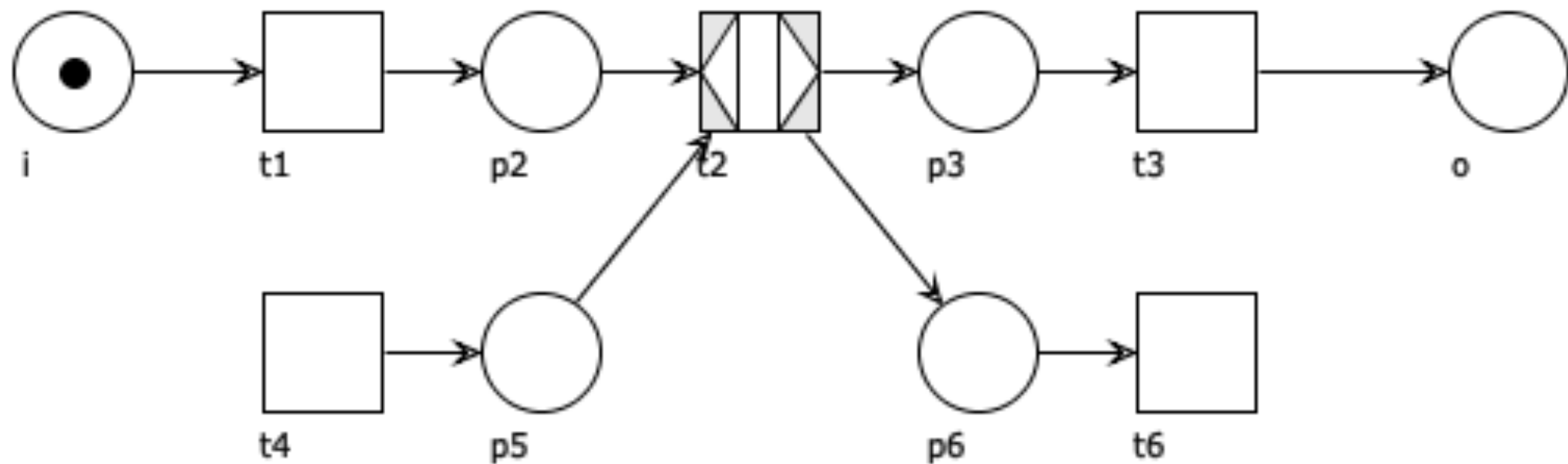

Question time

Do you see any problem in the workflow net below?

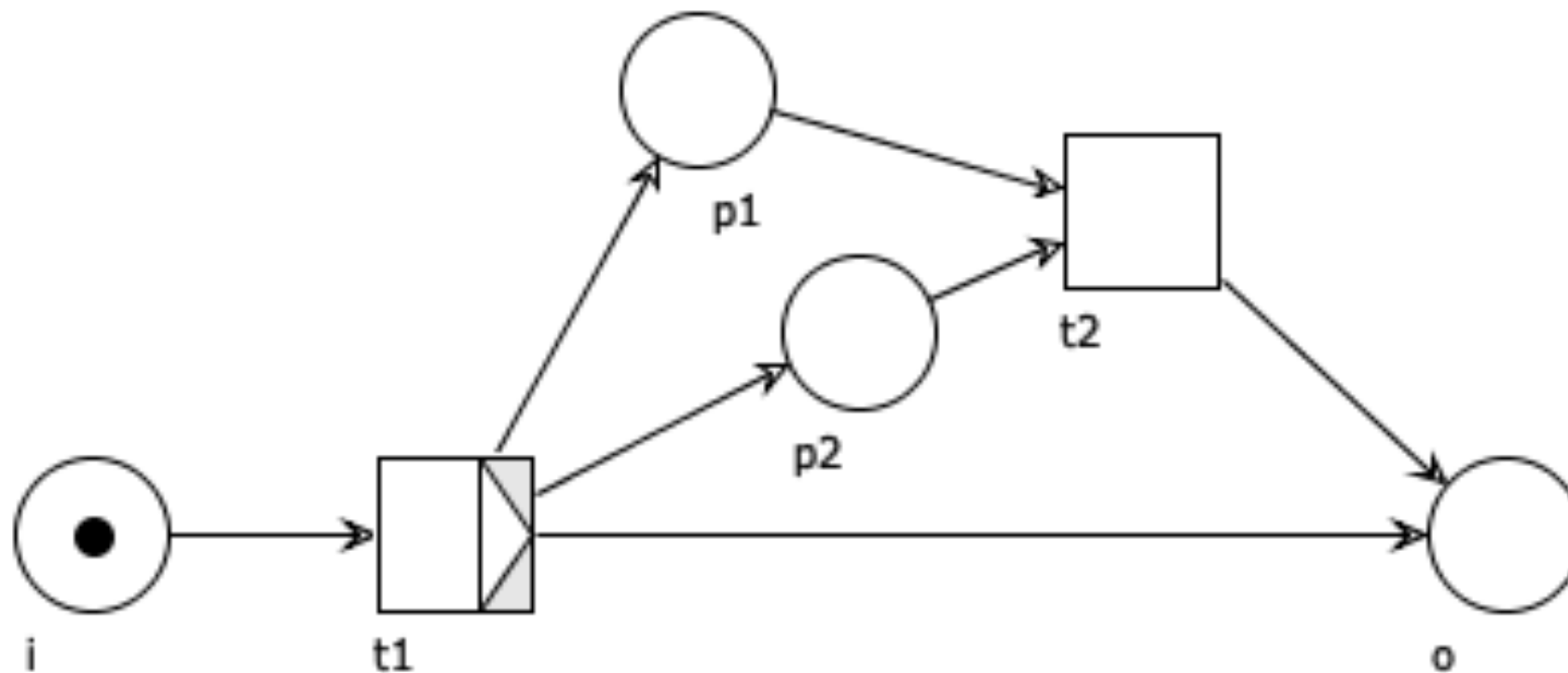

Question time

Do you see any problem in the workflow net below?

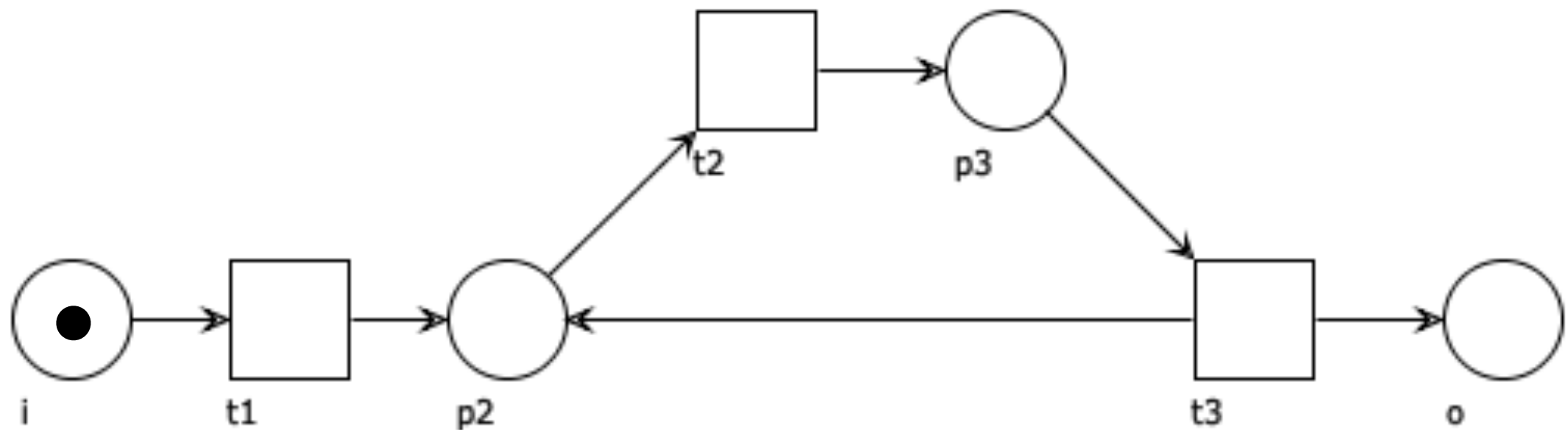

Question time

Livelock (divergence without producing output)

a case is trapped in a cycle with no opportunity to end
can arise in workflow nets

Draw a workflow net that suffers from livelock

Question time

Livelock (divergence without producing output)

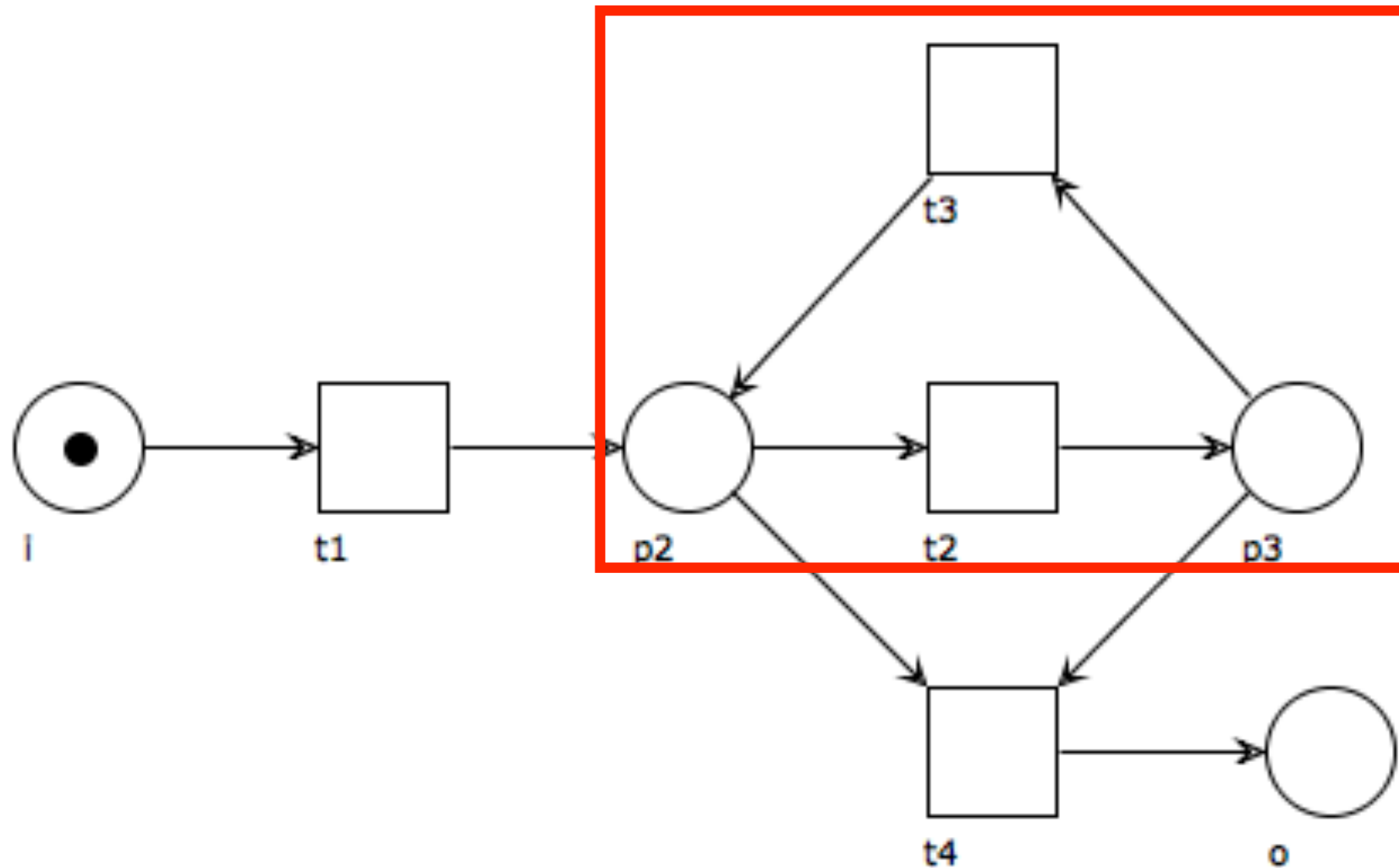

Remark

All the previous flaws are typical errors that
can be detected
without any knowledge about the actual content
of the Business Process

Verification and validation

Validation is concerned with
the relation between the model and the reality

How does a model fit log files?

Which model does fit better?

Verification aims to answer qualitative questions

Is there a deadlock possible?

Is it possible to successfully handle a specific case?

Will all cases terminate eventually?

Is it possible to execute a certain task?

Simulation techniques

Test analysis

Try and see if certain firing sequences are allowed by the workflow net

Using WoPeD:

Play (forward and backward) with net tokens

Record certain runs (to replay or explain)

Randomly select alternatives

Problem: how to make sure that all possible runs have been examined?

Reachability analysis

Verification by inspection

All possible runs of a workflow net are represented in its Reachability Graph (**when it is finite**)

Using WoPeD:

all reachable states are shown

(a single run does not necessarily visit all nodes)

End states are evident (no outgoing arc)

Useful to check if dangerous or undesired states can arise (e.g. the green-green state in the two-traffic-lights)

Problem: state explosion

Reachability analysis

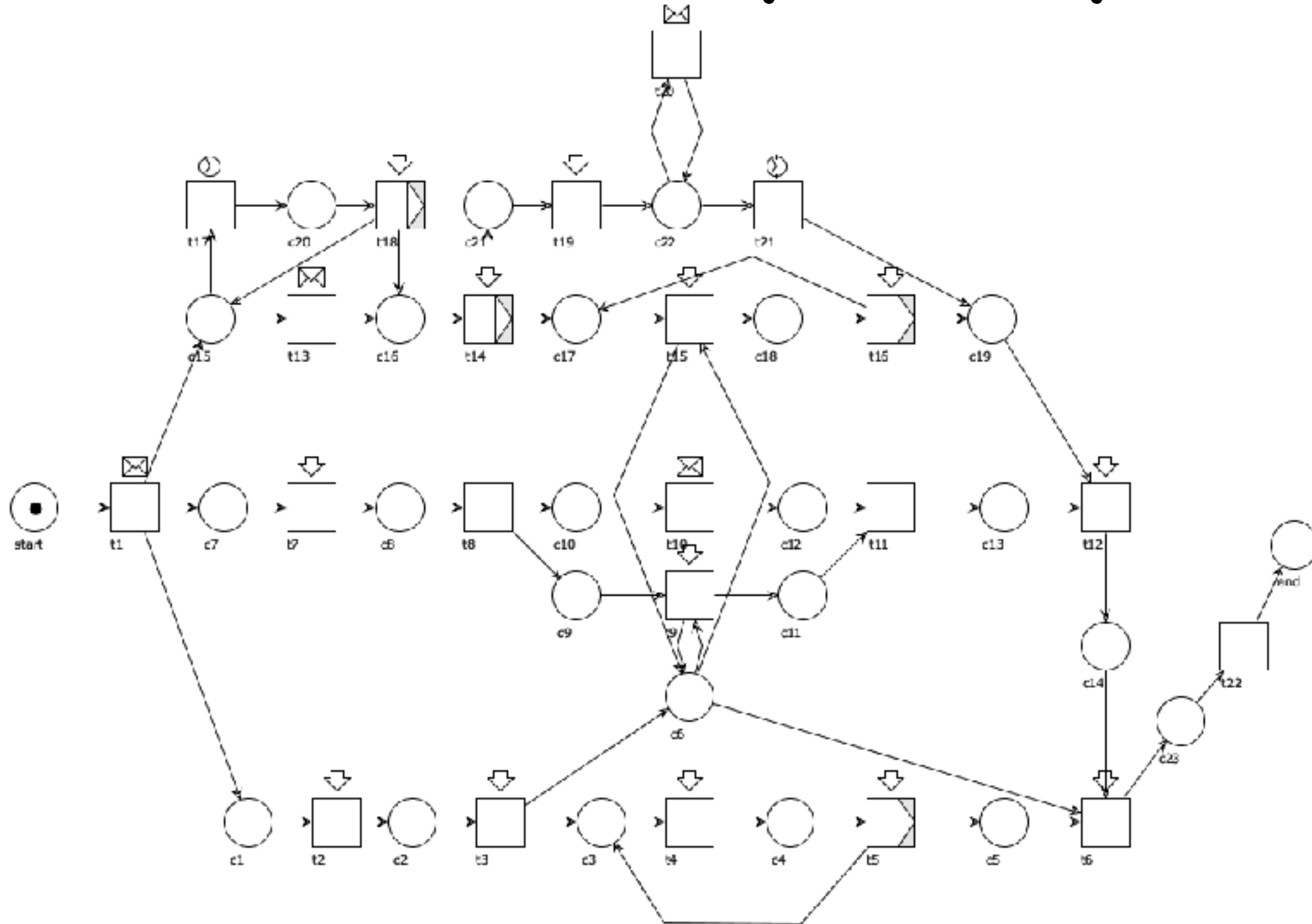

Reachability analysis

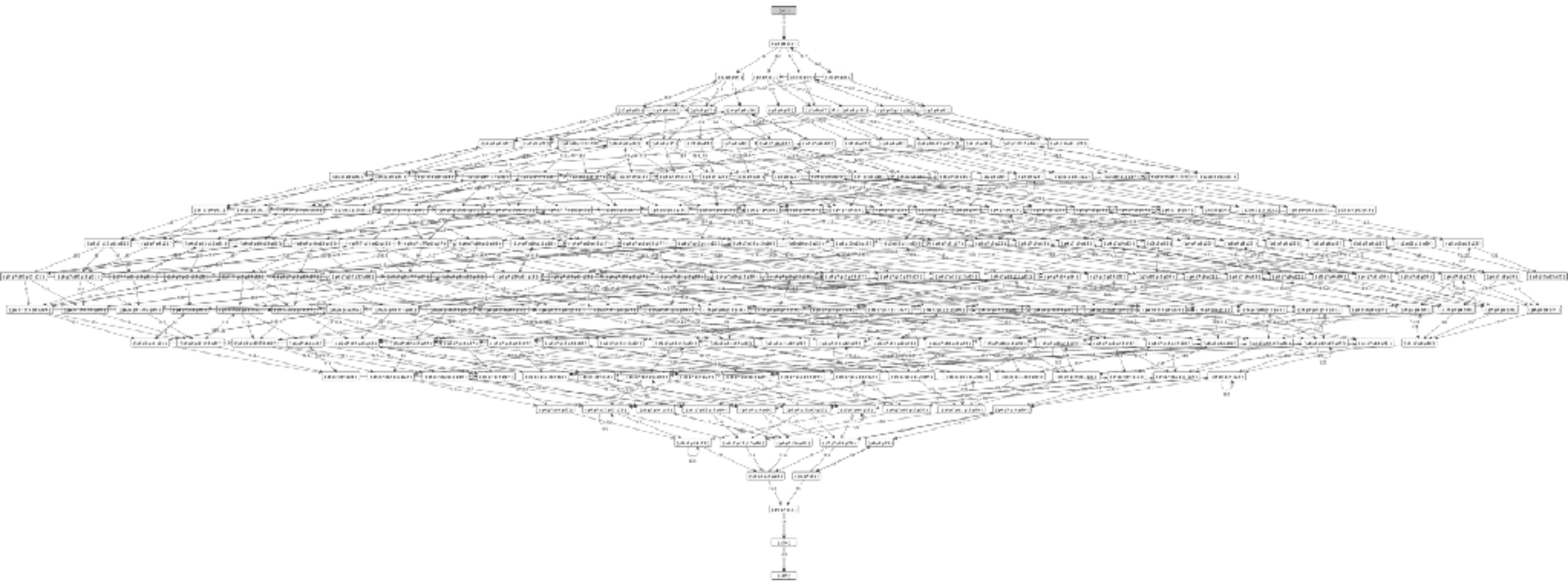

Problem: state explosion

Exercise

Do you see any problem in the workflow net below?

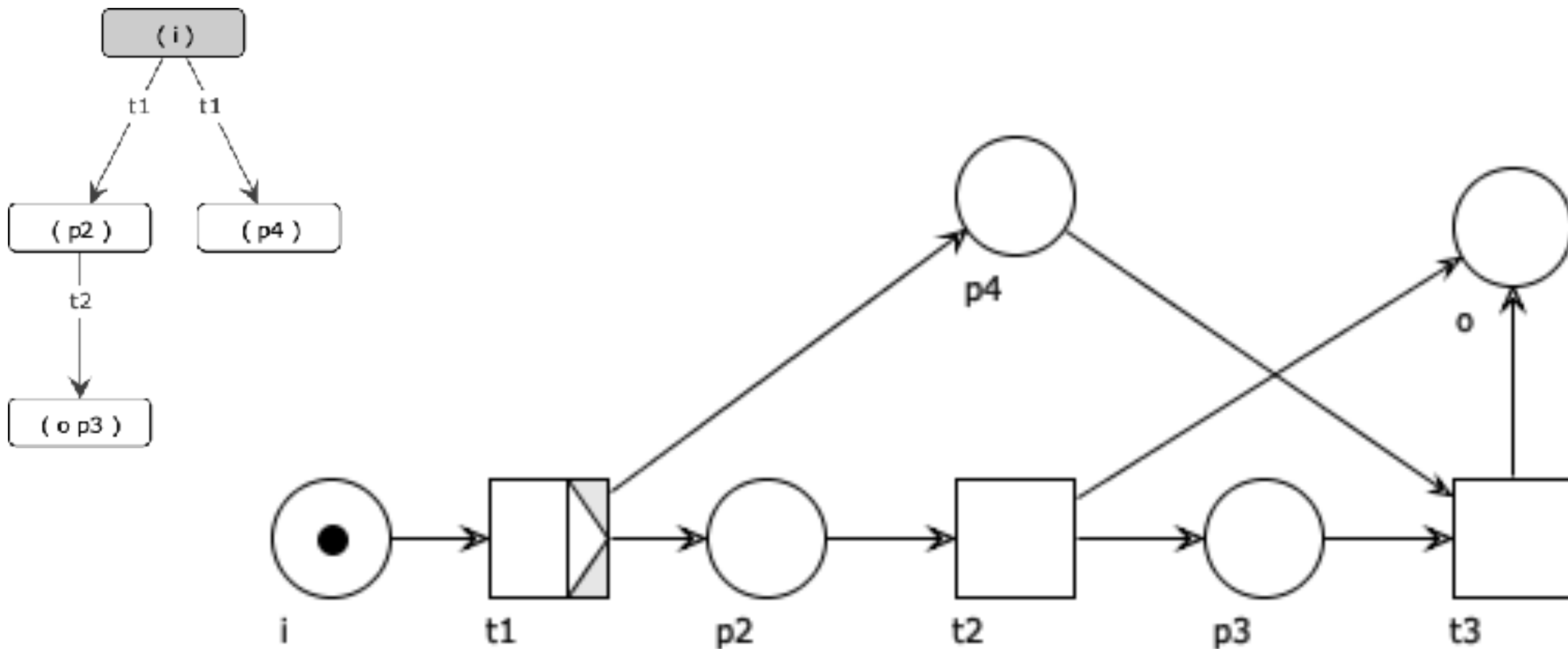

Exercise

Which problem(s) in the workflow net below?
How would you redesign the business process?

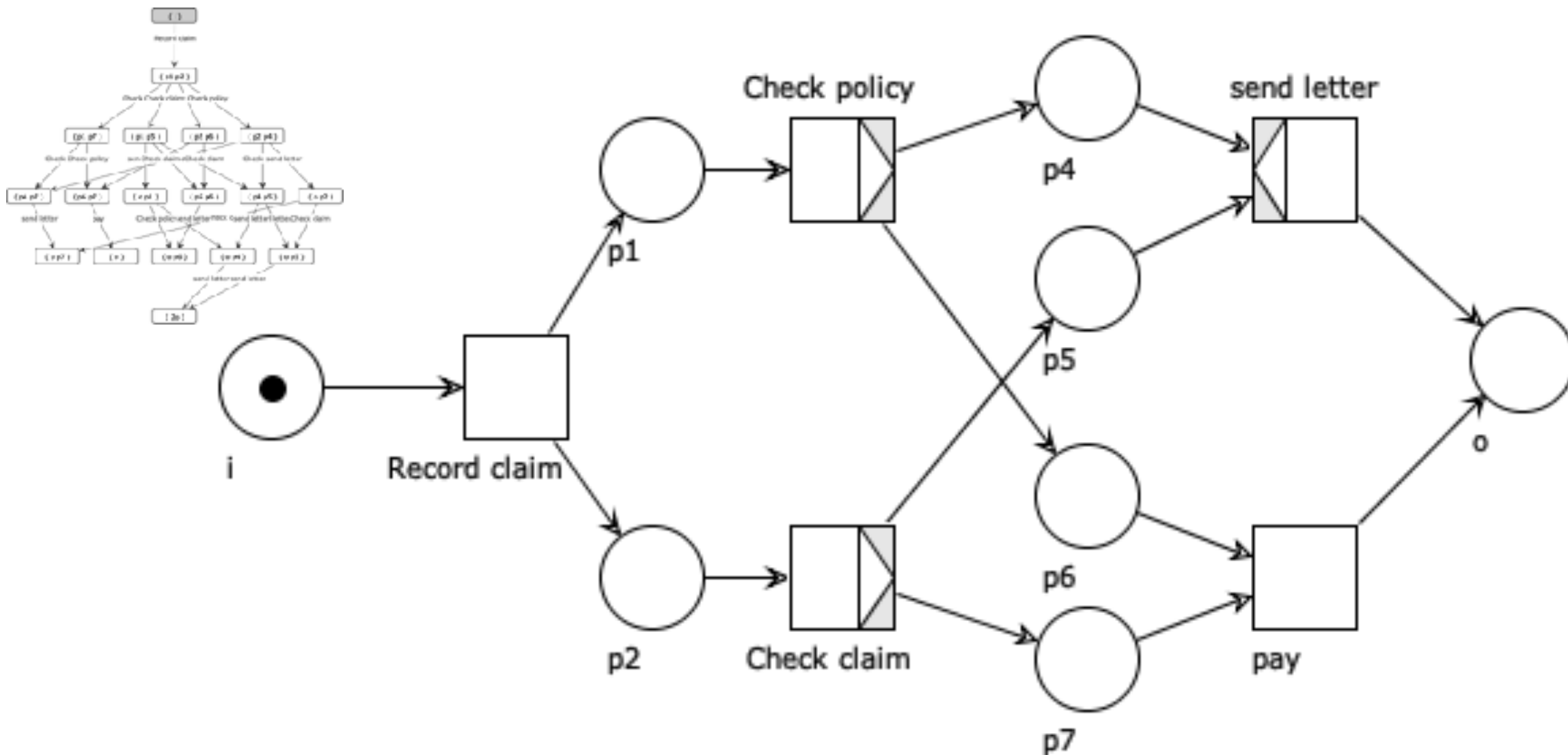

Coverability

Reachability analysis: finiteness?

Proposition:

The reachability graph of a net is finite

if and only if

the net is bounded

Reachability analysis: finiteness?

Proposition:
A net is unbounded

if and only if

its reachability graph is not finite

Coverability graph

A **coverability graph** is a finite over-approximation of the reachability graph

It allows for markings with infinitely many tokens in one place (called extended bags)

$$B : P \longrightarrow \mathbb{N} \cup \{\infty\}$$

Discover unbounded places

Suppose

$$M_0 \xrightarrow{t_1} M_1 \xrightarrow{t_2} M_2 \dots \xrightarrow{t_i} M_i \dots \xrightarrow{t_j} M_j$$

with $M_i \subset M_j$

Let $M = M_i$ and $M' = M_j$ and $L = M' - M$

By the monotonicity Lemma we have, for any $n \in \mathbb{N}$:

$$M \rightarrow^* M + L \rightarrow^* M + 2L \rightarrow^* \dots \rightarrow^* M + nL$$

Hence all places p marked by L (i.e. if $L(p) > 0$) are unbounded

Cover unbounded places

Idea:

When computing the RG, if M' is found s.t.

$$M_0 \rightarrow^* M \rightarrow^* M' \text{ with } M \subset M'$$

Add the extended bag B (instead of M') to the graph

$$\text{where } B(p) = \begin{cases} M'(p) & \text{if } M'(p) - M(p) = 0 \\ \infty & \text{otherwise} \end{cases}$$

A few remarks

Idea: mark unbounded places by ∞

Remind: $M \subset M'$ means that $M \subseteq M' \wedge M \neq M'$, i.e.,

1. for any $p \in P$, $M'(p) \geq M(p)$
2. there exists at least one place $q \in P$ such that $M'(q) > M(q)$

Remark:

Requiring $M_0 \rightarrow^* M \rightarrow^* M'$ is different than requiring $M, M' \in [M_0 \rangle$

Operations on extended bags

Inclusion: Let $B, B' : P \rightarrow \mathbb{N} \cup \{\infty\}$

We write $B \subseteq B'$ if for any p we have

$$B'(p) = \infty \text{ or } B(p), B'(p) \in \mathbb{N} \wedge B(p) \leq B'(p)$$

Sum: Let $B, B' : P \rightarrow \mathbb{N} \cup \{\infty\}$

$$(B + B')(p) = \begin{cases} \infty & \text{if } B(p) = \infty \text{ or } B'(p) = \infty \\ B(p) + B'(p) & \text{if } B(p), B'(p) \in \mathbb{N} \end{cases}$$

Difference: Let $B : P \rightarrow \mathbb{N} \cup \{\infty\}$ and $M : P \rightarrow \mathbb{N}$ with $M \subseteq B$

$$(B - M)(p) = \begin{cases} \infty & \text{if } B(p) = \infty \\ B(p) - M(p) & \text{if } B(p) \in \mathbb{N} \end{cases}$$

Compute a reachability graph

1. Initially $N = \{ M_0 \}$ and $A = \emptyset$

(all bags are finite in this case)

Compute a reachability graph

1. Initially $N = \{ M_0 \}$ and $A = \emptyset$
2. Take a bag $B \in N$ and a transition $t \in T$ such that
 1. B enables t and there is no arc labelled t leaving from B

(all bags are finite in this case)

Compute a reachability graph

1. Initially $N = \{ M_0 \}$ and $A = \emptyset$
2. Take a bag $B \in N$ and a transition $t \in T$ such that
 1. B enables t and there is no arc labelled t leaving from B
3. Let $B' = B - \cdot t + t \cdot$

(all bags are finite in this case)

Compute a reachability graph

1. Initially $N = \{ M_0 \}$ and $A = \emptyset$
2. Take a bag $B \in N$ and a transition $t \in T$ such that
 1. B enables t and there is no arc labelled t leaving from B
3. Let $B' = B - \cdot t + t \cdot$
4. Add B' to N and (B, t, B') to A

(all bags are finite in this case)

Compute a reachability graph

1. Initially $N = \{ M_0 \}$ and $A = \emptyset$
2. Take a bag $B \in N$ and a transition $t \in T$ such that
 1. B enables t and there is no arc labelled t leaving from B
3. Let $B' = B - \cdot t + t \cdot$
4. Add B' to N and (B, t, B') to A
5. Repeat steps 2,3,4 until no new arc can be added

(all bags are finite in this case)

Compute a reachability graph

1. Initially $N = \{ M_0 \}$ and $A = \emptyset$
2. Take a bag $B \in N$ and a transition $t \in T$ such that
 1. B enables t and there is no arc labelled t leaving from B
3. Let $B' = B - \cdot t + t \cdot$
4. Add B' to N and (B, t, B') to A
5. Repeat steps 2,3,4 until no new arc can be added

(all bags are finite in this case)

Compute a coverability graph

1. Initially $N = \{ M_0 \}$ and $A = \emptyset$
2. Take a bag $B \in N$ and a transition $t \in T$ such that
 1. B enables t and there is no arc labelled t leaving from B
3. Let $B' = B - \cdot t + t \cdot$
4. Let B_c' such that for any $p \in P$
 1. $B_c'(p) = \infty$ if there is a node $B'' \in N$ such that
 1. there is a directed path from B'' to B in the graph (N, A)
 2. $B'' \subset B'$,
 3. $B''(p) < B'(p)$
 2. $B_c'(p) = B'(p)$ otherwise
5. Add B_c' to N and (B, t, B_c') to A
6. Repeat steps 2,3,4,5 until no new arc can be added

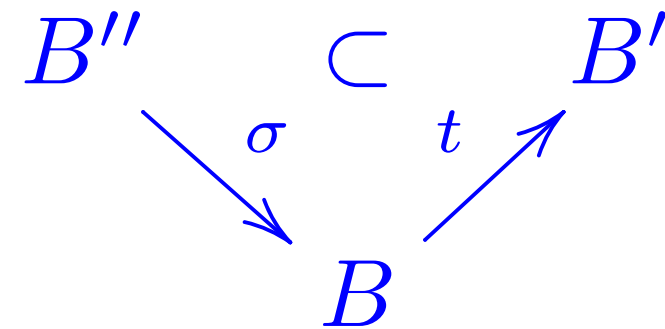

Example

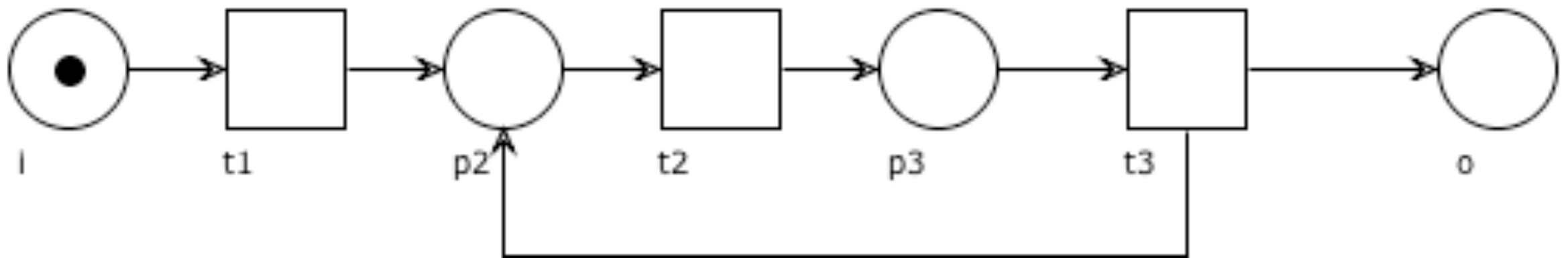

i

Example

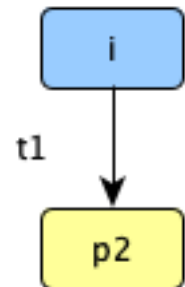
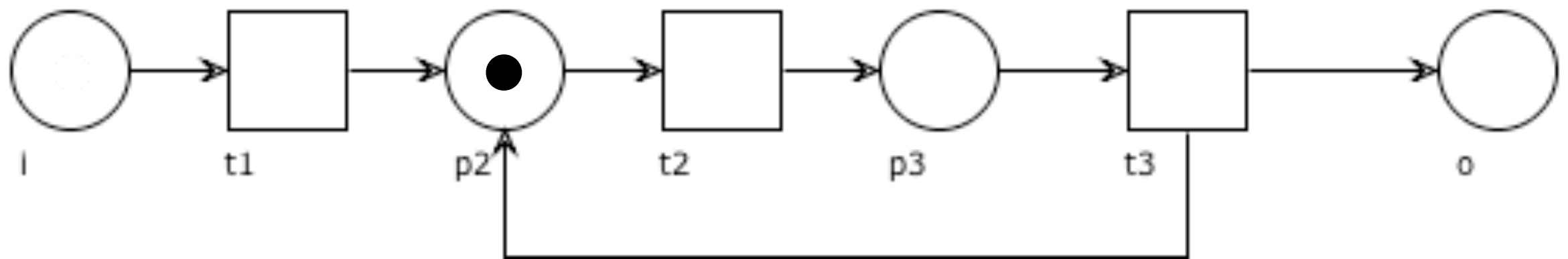

Example

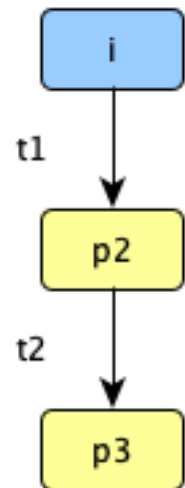
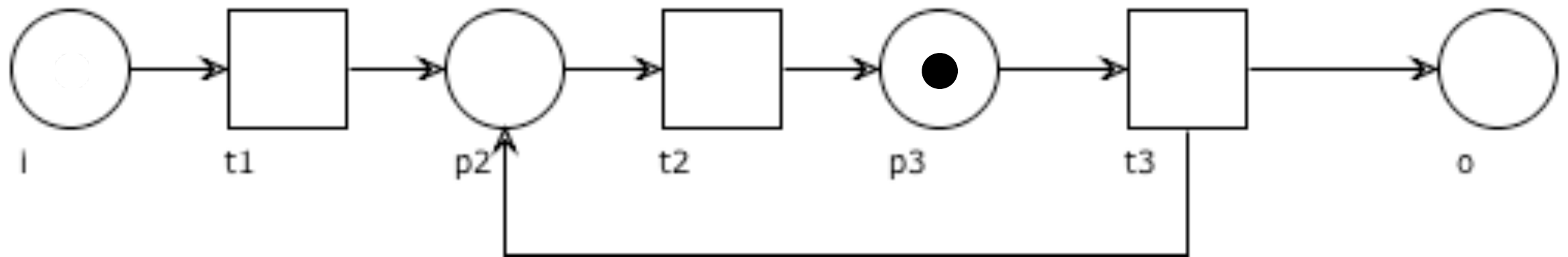

Example

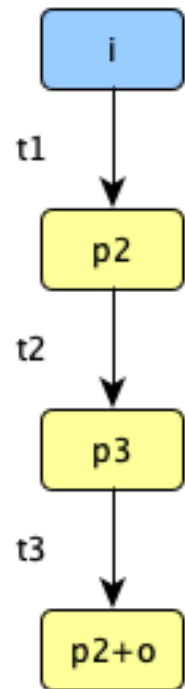
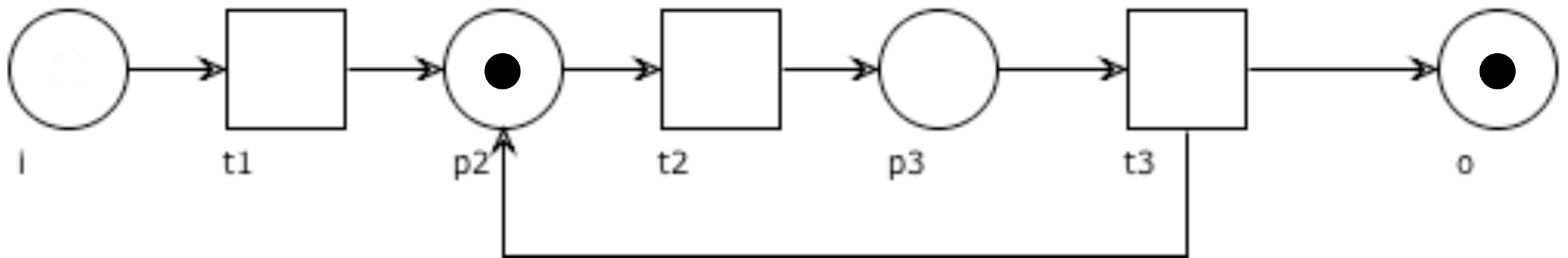

Example

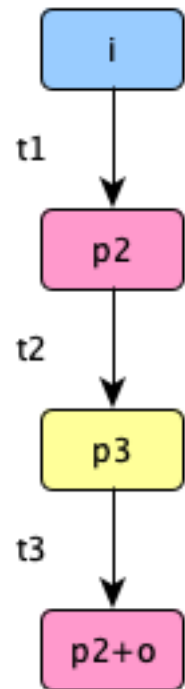
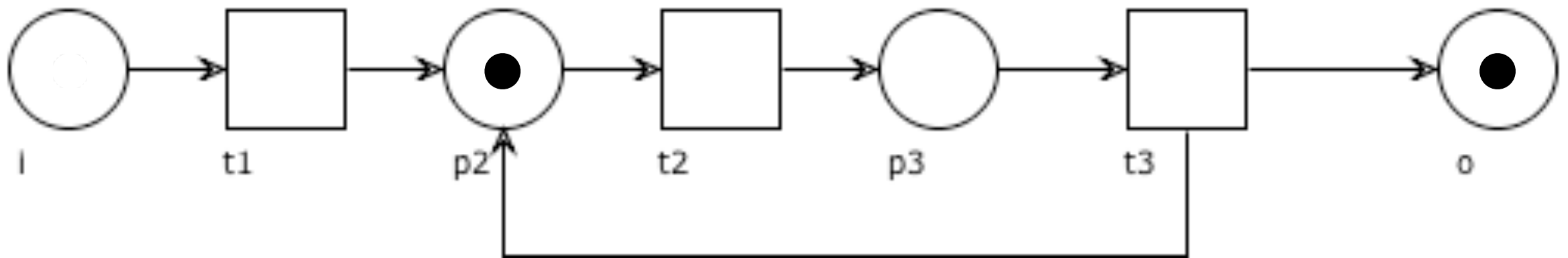

Example

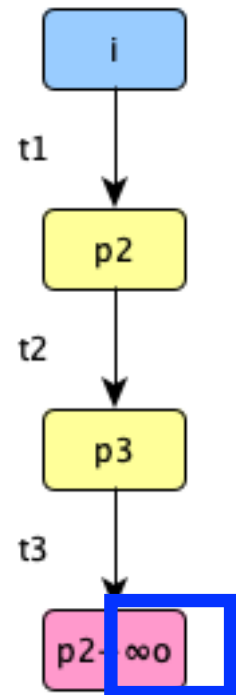
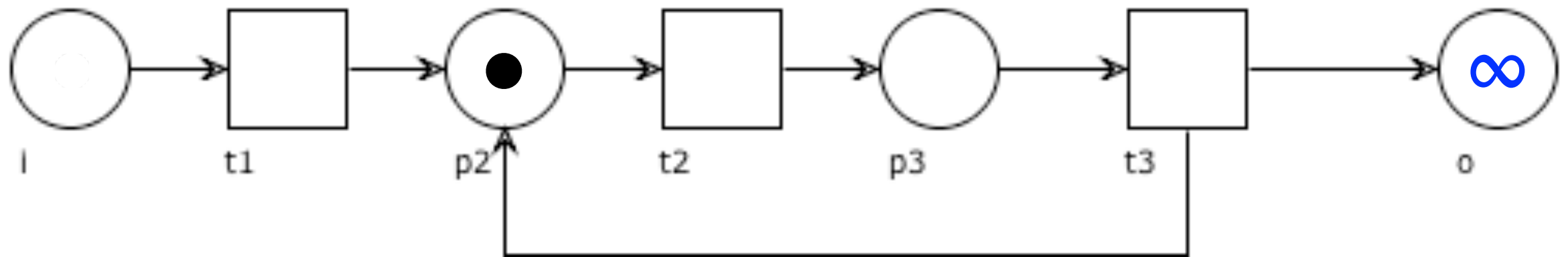

Example

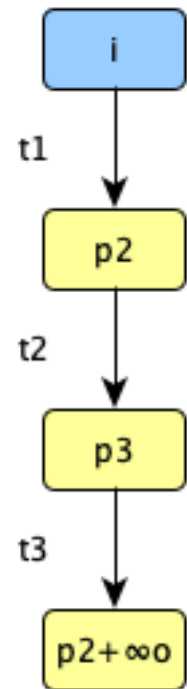
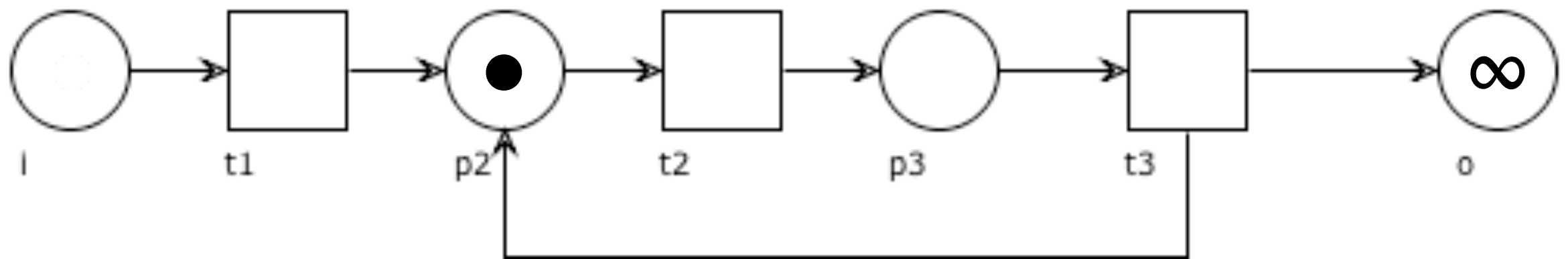

Example

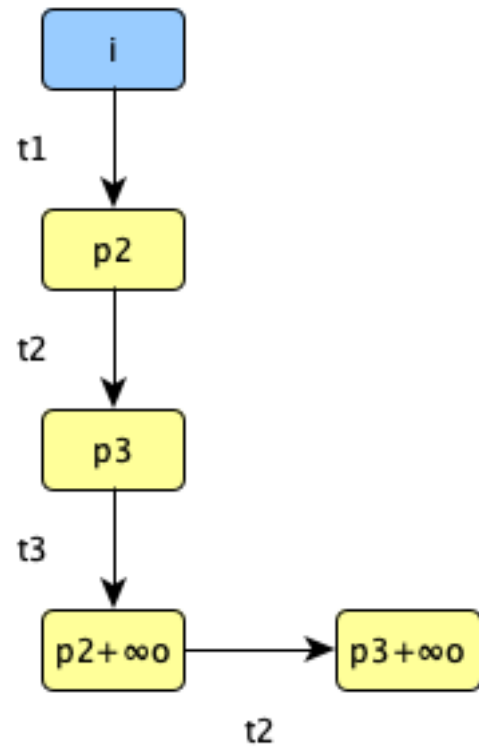
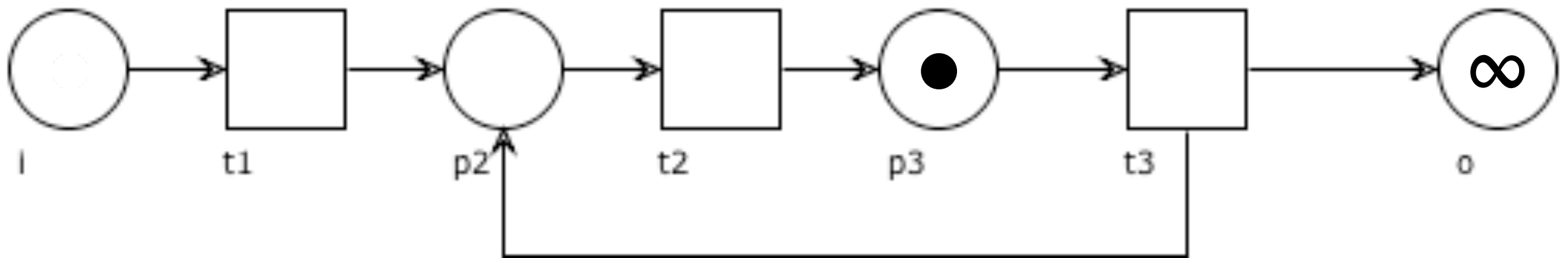

Example

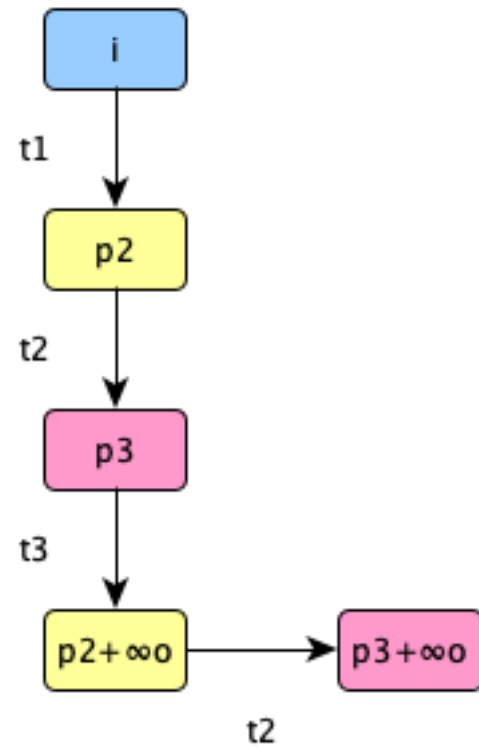
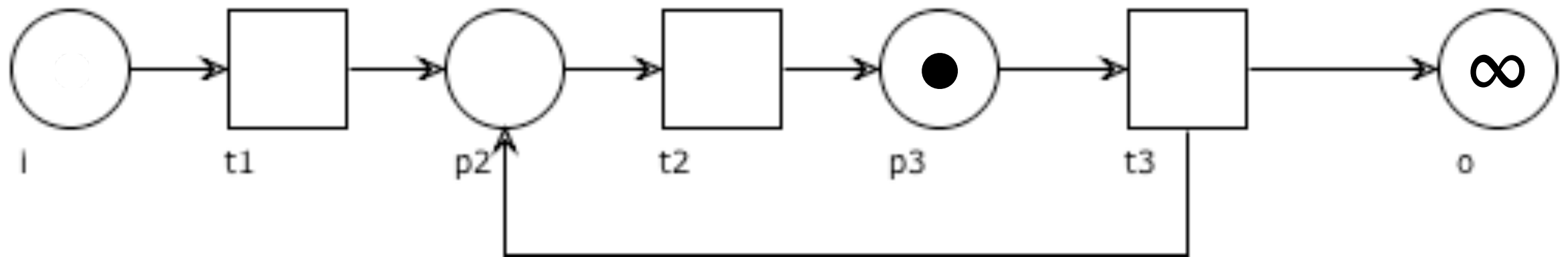

Example

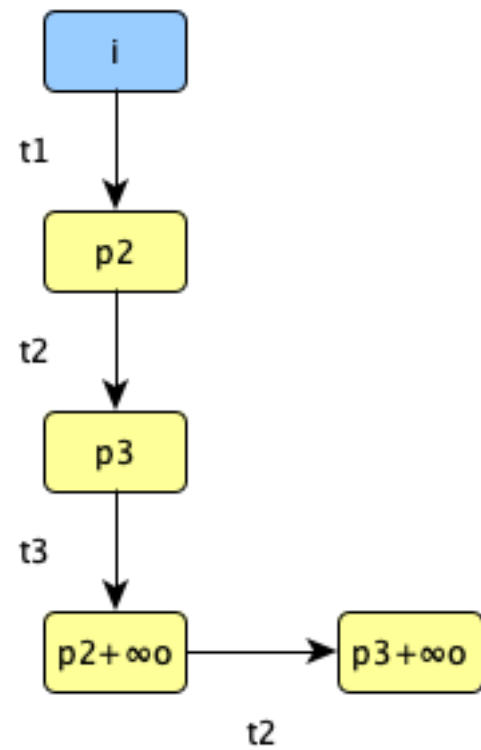
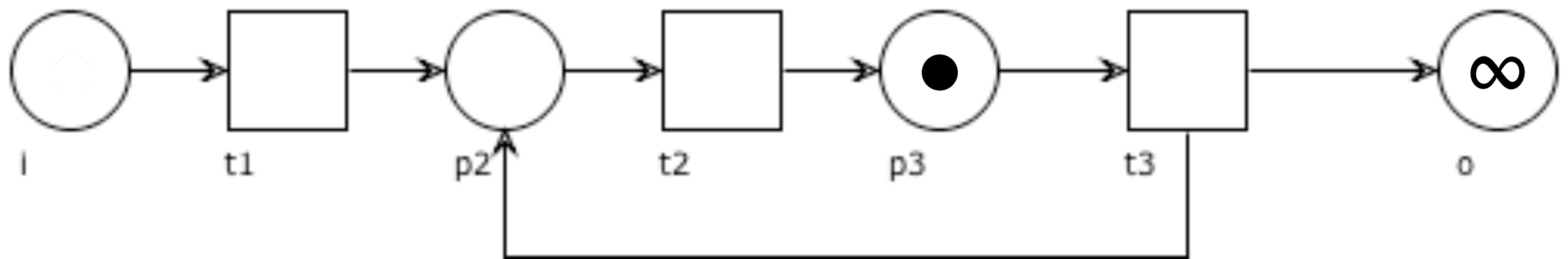

Example

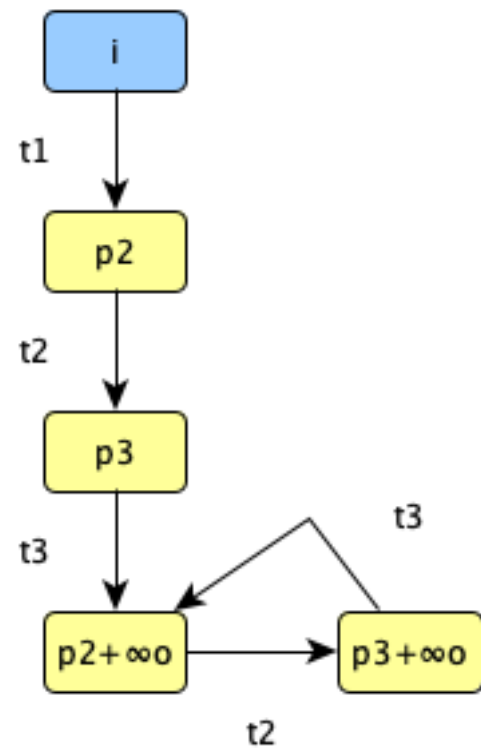
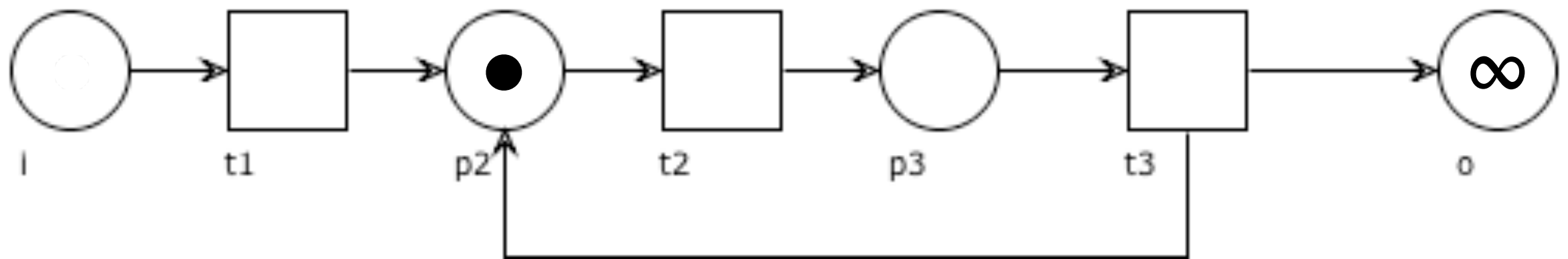

Properties of coverability graphs

A coverability graph **is always finite**,
but in general it **is not uniquely defined**
(it depends on which B and t are selected at step 2)

Every firing sequence has a corresponding path in the CG
(the converse is not necessarily true)

Any path in a CG that visits only finite markings
corresponds to a firing sequence

If the RG is finite, then it coincides with the CG

Reachability analysis by coverability

All possible behaviours of a workflow net are represented exactly in the Reachability Graph (if finite)

We use Coverability Graph when necessary (RG not finite)

WoPeD computes a Coverability Graph

Example

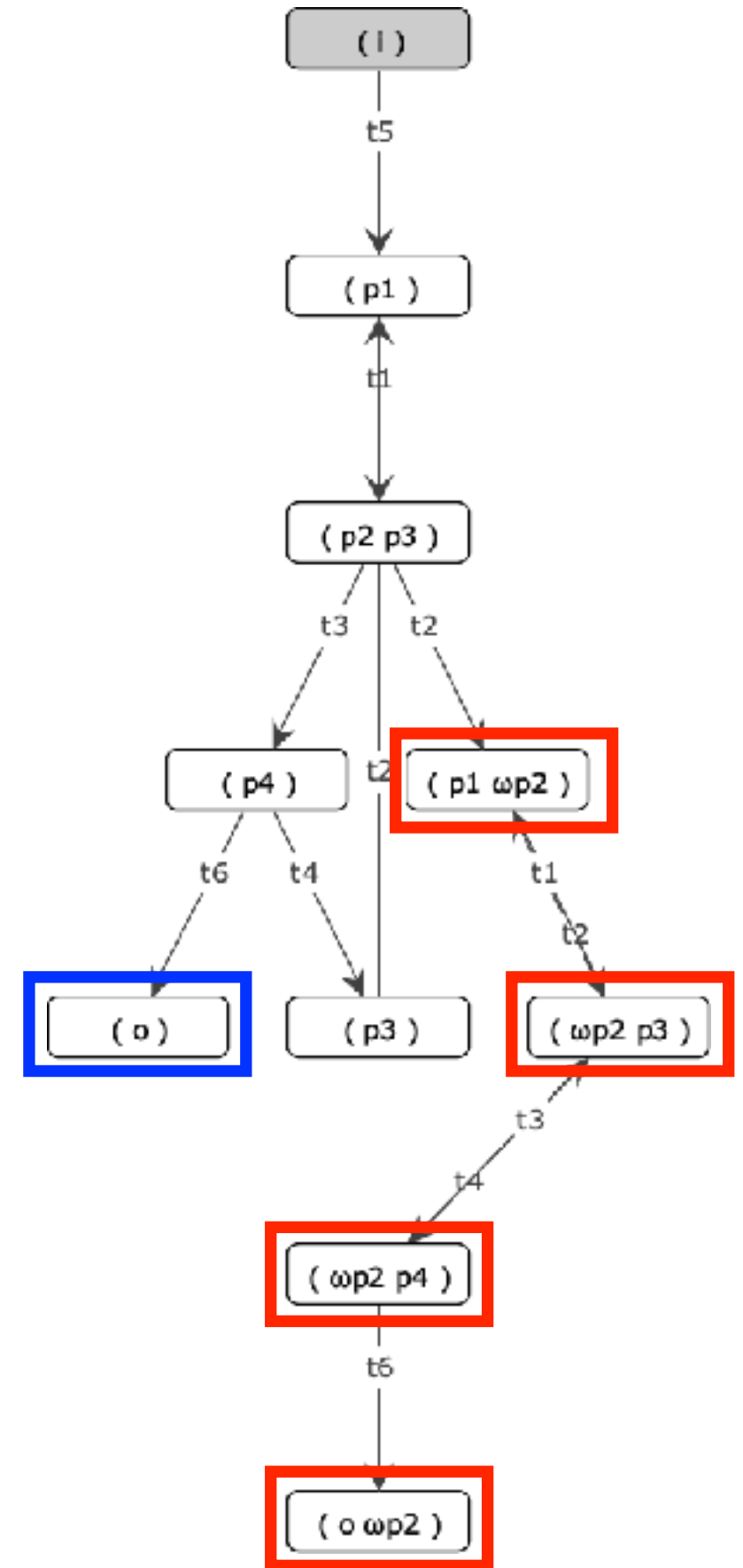
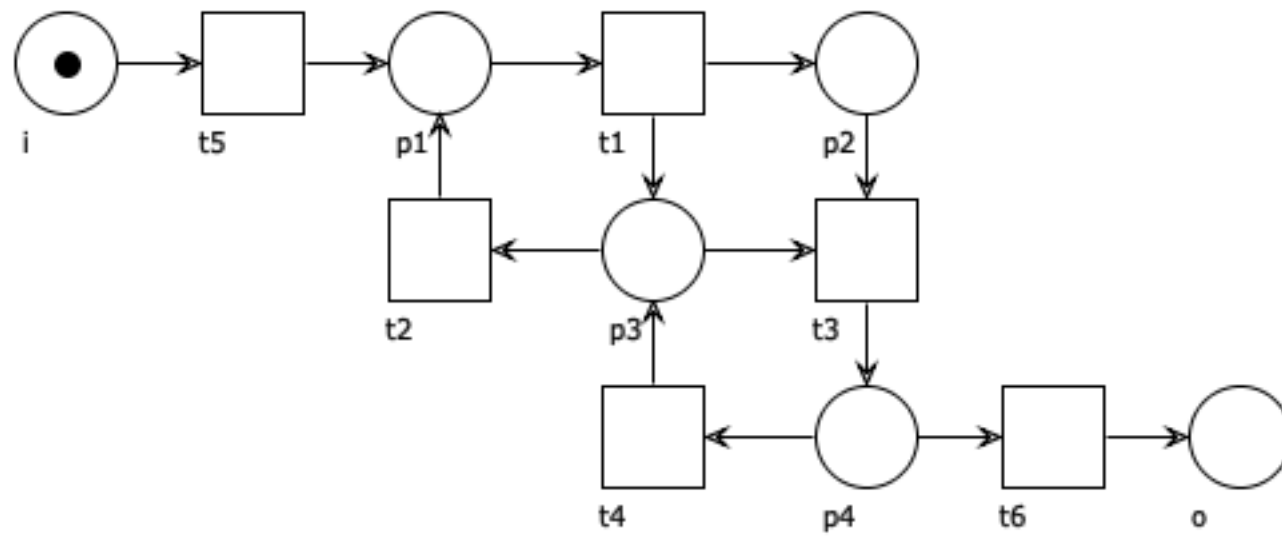

Soundness

Soundness of Business Processes

A process is called **sound** if

1. it contains no unnecessary tasks
2. every case is always completed in full
3. no pending items are left after case completion

Soundness of Business Processes

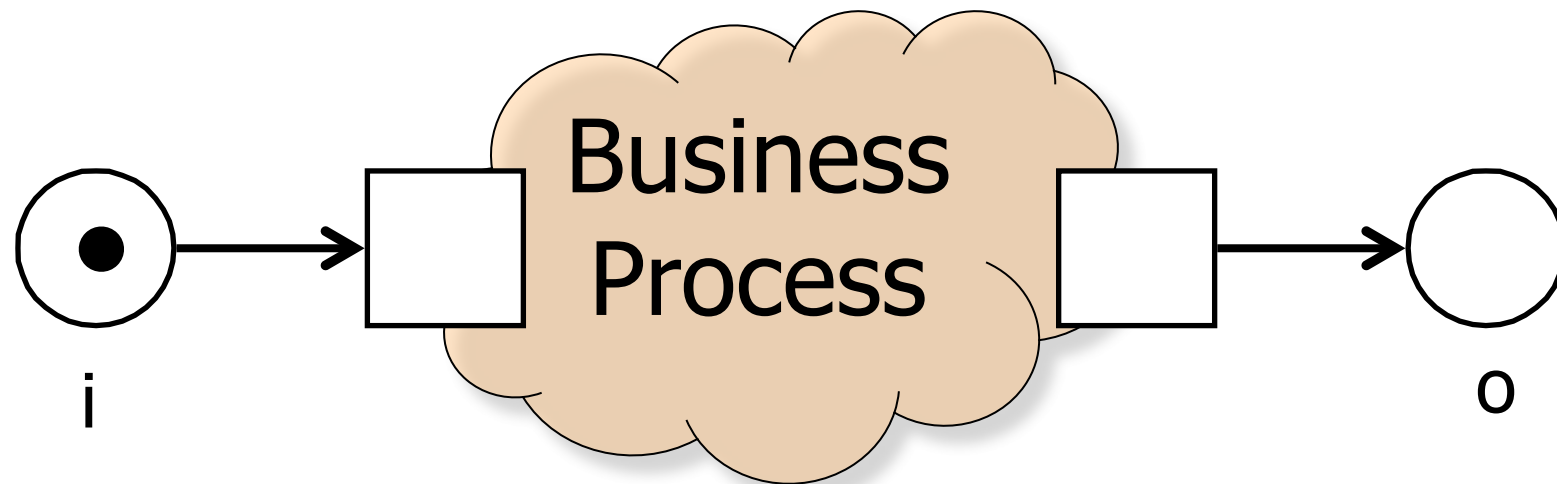

Soundness of Workflow nets

A workflow net is called **sound** if

1. for each transition t ,
there is a marking M (reachable from i) that enables t
2. for each token put in place i ,
one token eventually appears in the place o
3. when a token is in place o , all other places are empty

Fairness assumption

Remark:

Condition 2 does not mean that iteration must be forbidden or bound

It says that from any reachable marking M there must be possible to reach o in some steps

Fairness assumption:

A task cannot be postponed indefinitely

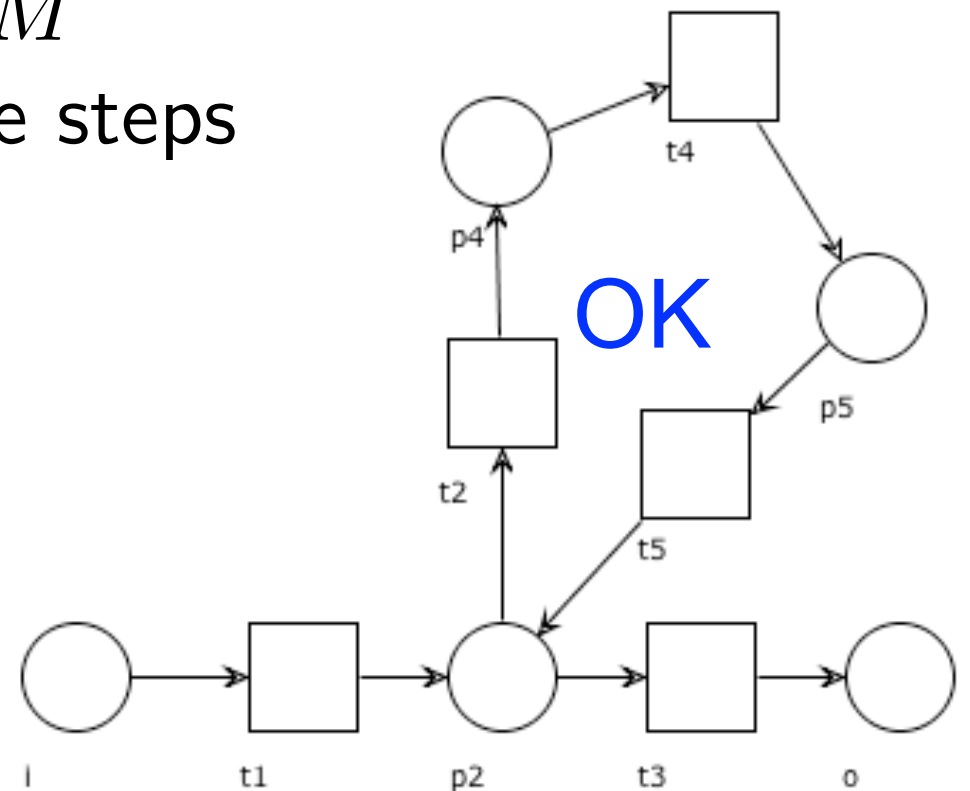

Soundness, Formally

A workflow net is called **sound** if

no dead task no transition is dead

$$\forall t \in T. \exists M \in [i \rangle. M \xrightarrow{t}$$

option to complete place o is eventually marked

$$\forall M \in [i \rangle. \exists M' \in [M \rangle. M'(o) \geq 1$$

proper completion when o is marked, no other token is left

$$\forall M \in [i \rangle. M(o) \geq 1 \Rightarrow M = o$$

1: no dead tasks

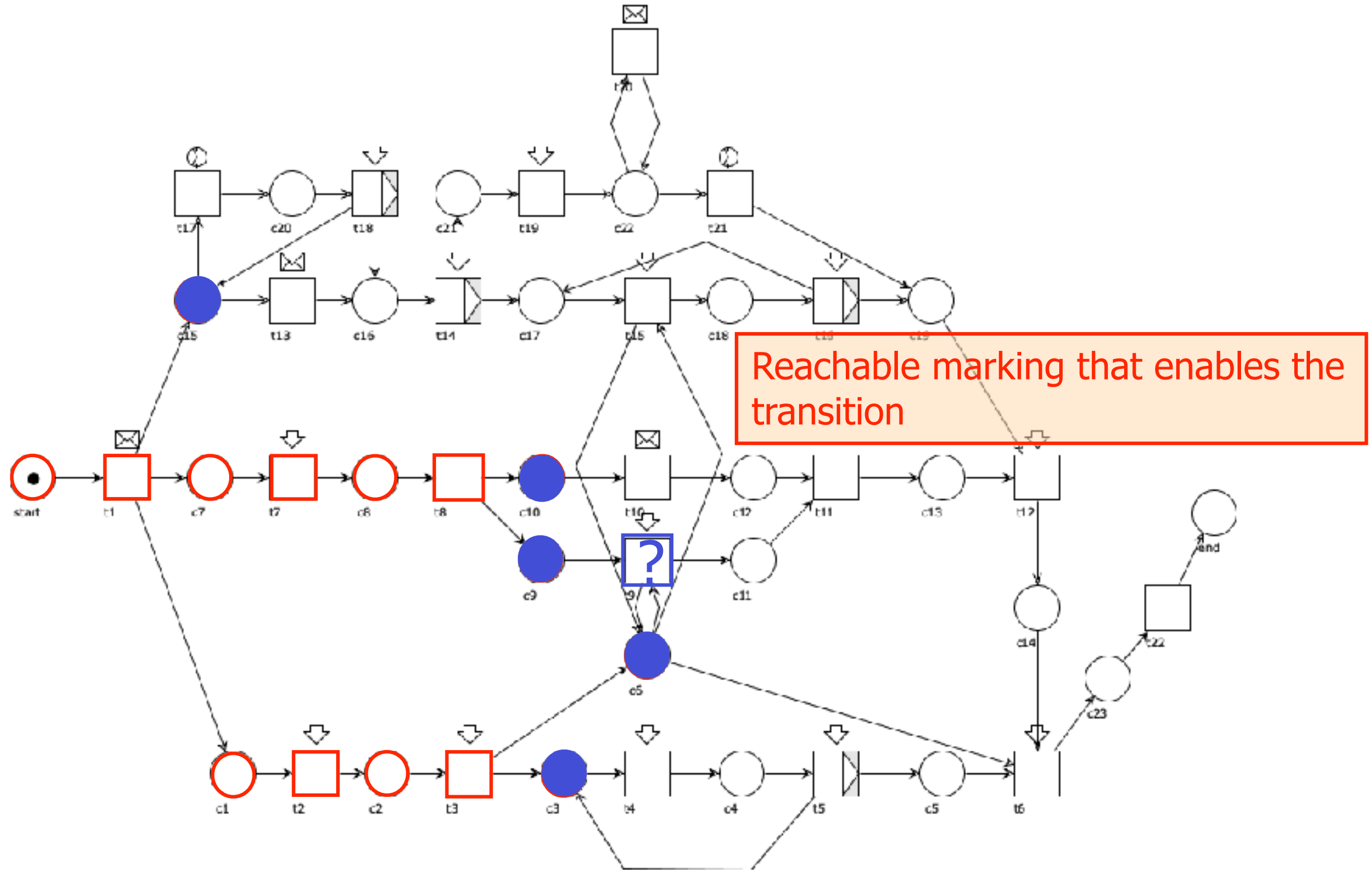

1: no dead tasks

The check must be repeated for each task

2: option to complete

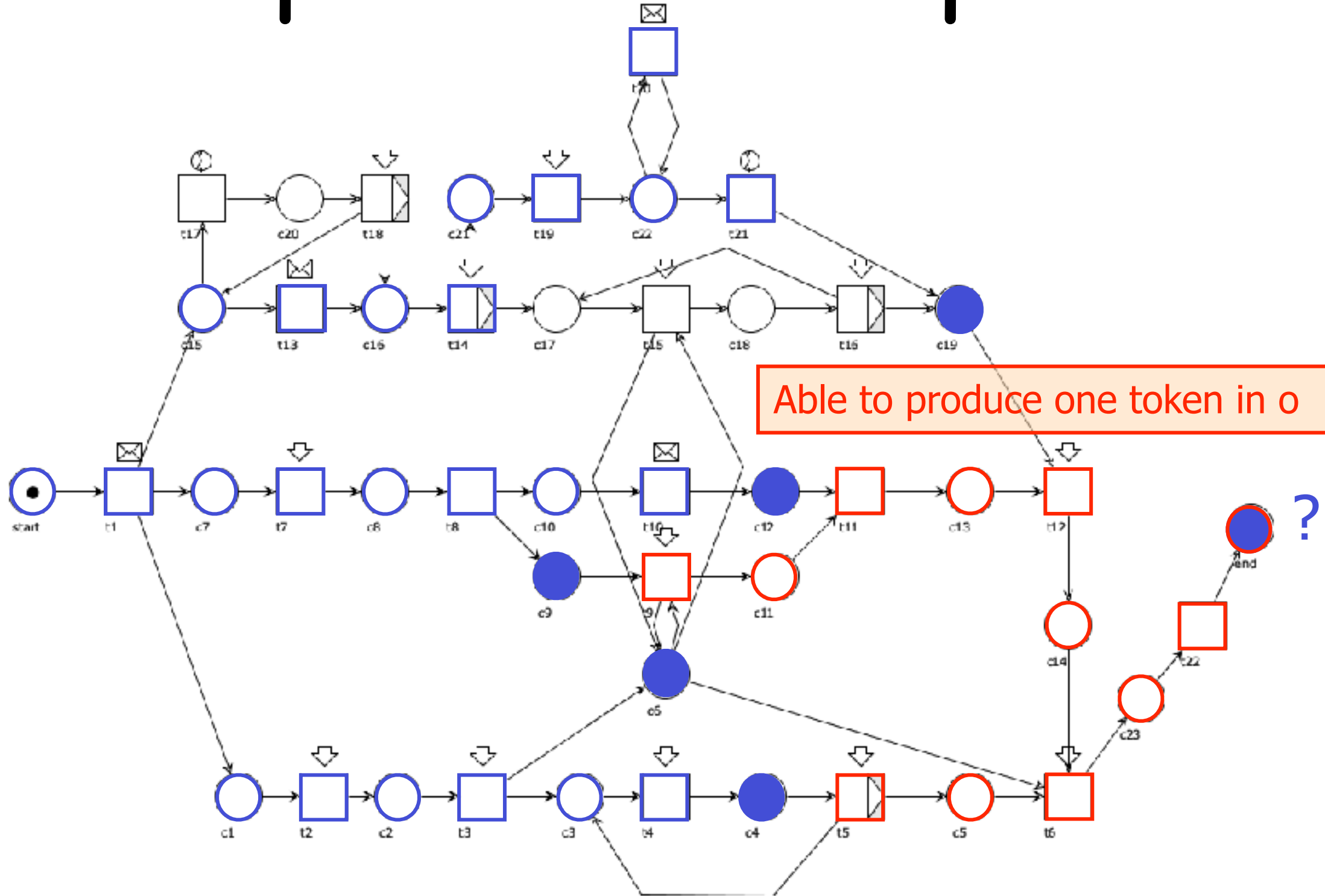

2: option to complete

The check must be repeated for each reachable marking

3: proper completion

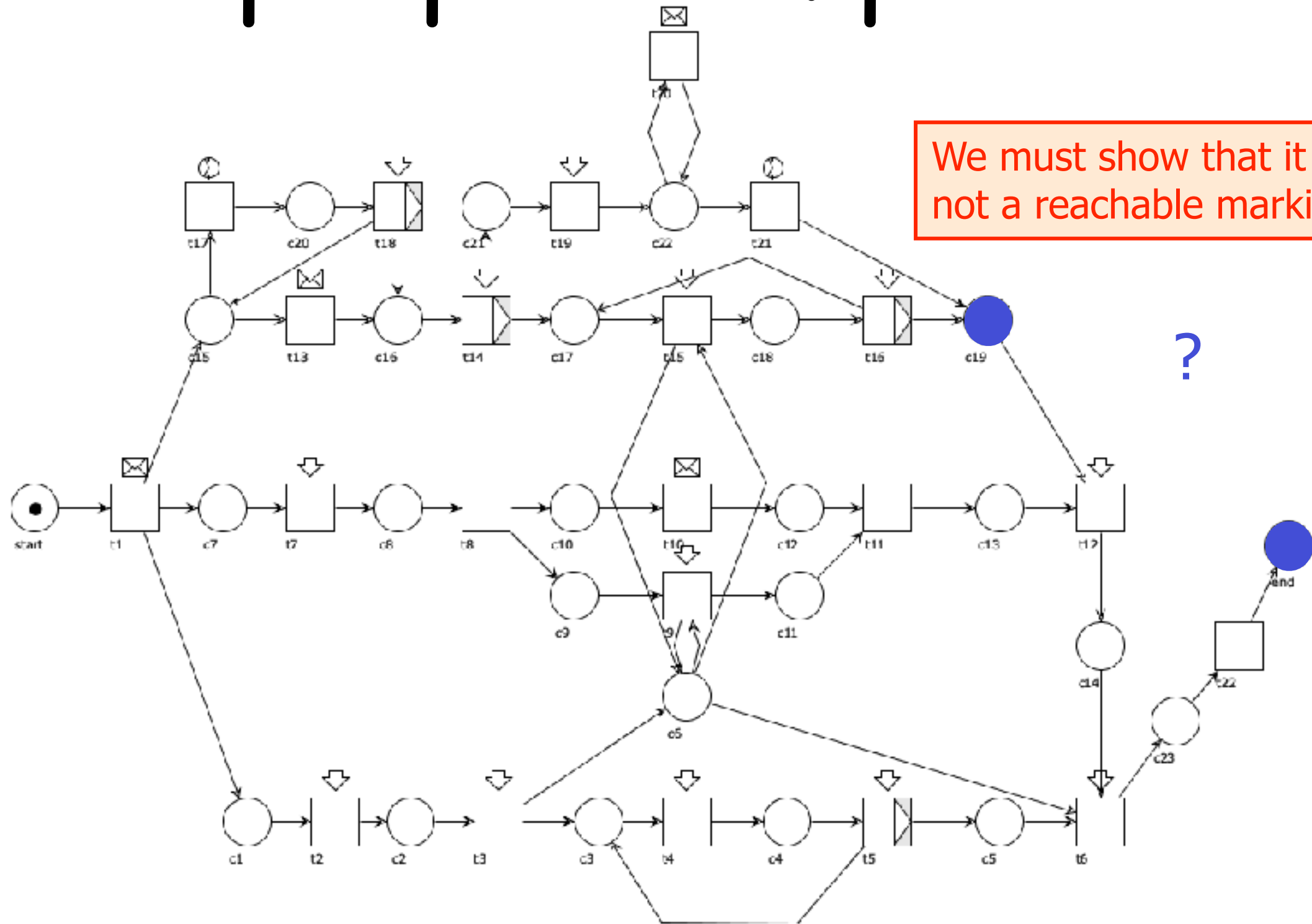

We must show that it is not a reachable marking

3: proper completion

The check must be repeated for each marking M
such that $M > 0$

Brute-force analysis

First, check if the Petri net is a workflow net
easy "syntactic" check

Second, check if it is sound (more difficult):
build the Reachability Graph

to check 1: for each transition t there must be an arc in the
RG that is labelled with t

to check 2&3: the RG must have only one final state (sink),
that consists of one token in o
and is reachable from any other state,
and no other marking has a token in o

Some Pragmatic Considerations

All checks can better be done automatically
(computer aided)

but nevertheless RG construction...

1. can be computationally expensive for large nets
(because of state explosion)
2. provides little support in repairing unsound processes
3. can be infinite (CG can be used, but it is not exact)

Advanced support

Translate soundness to other well-known properties that can be checked more efficiently:

boundedness and liveness

N^*

Play once

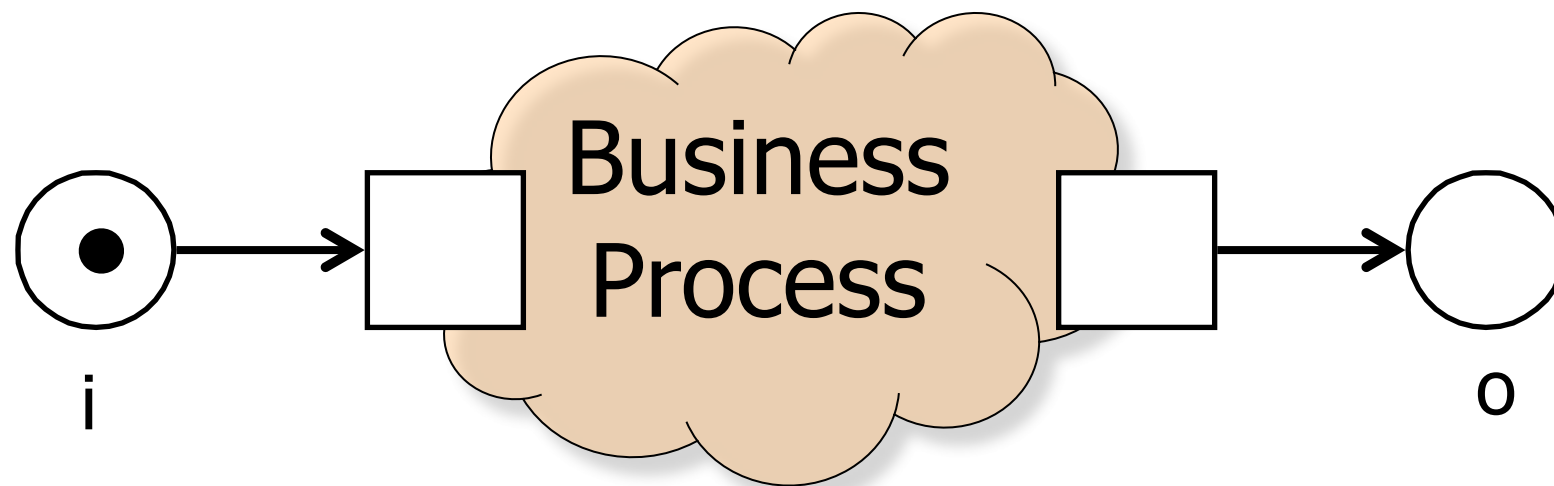

Play twice

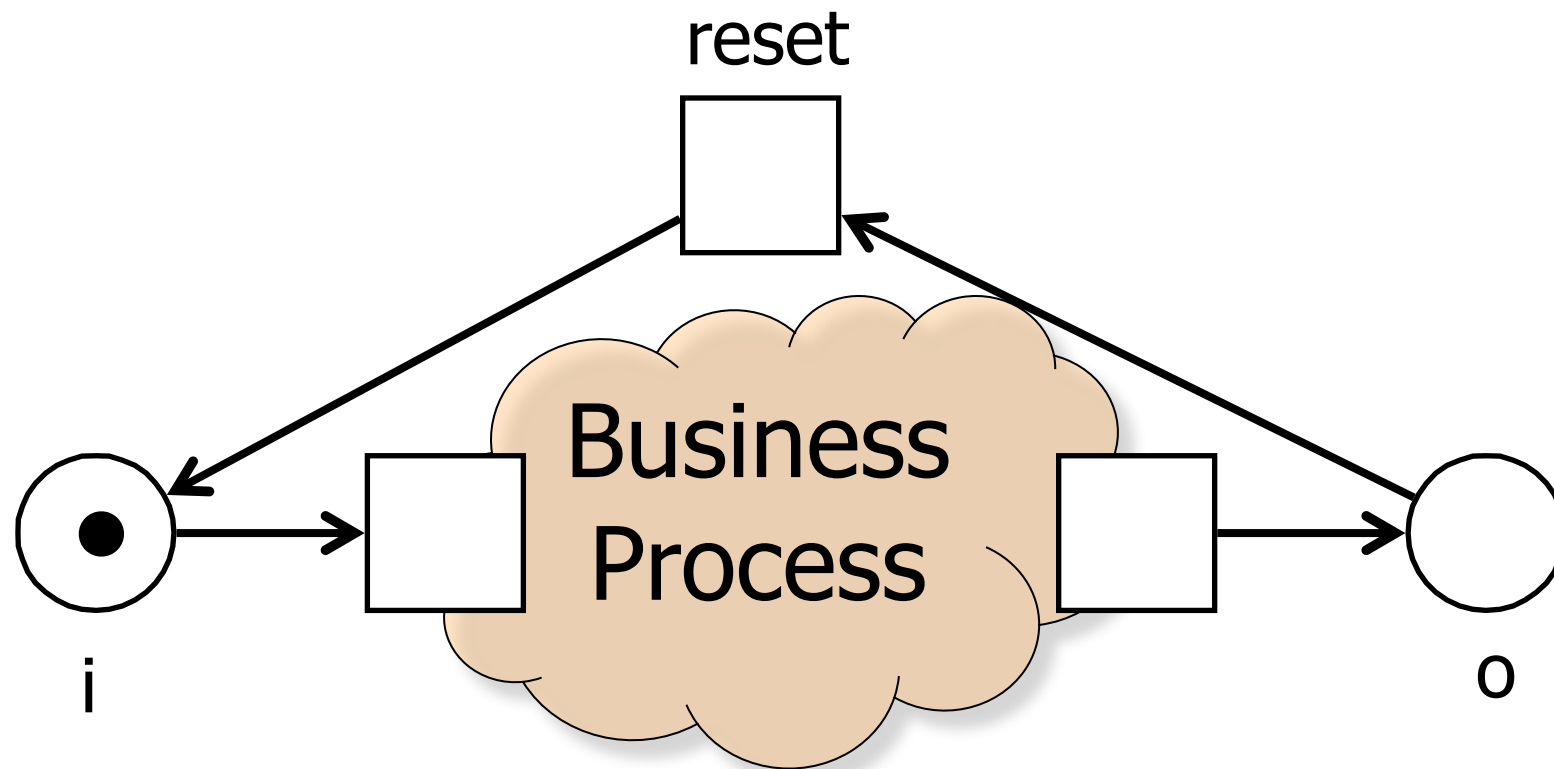

Play any number of times

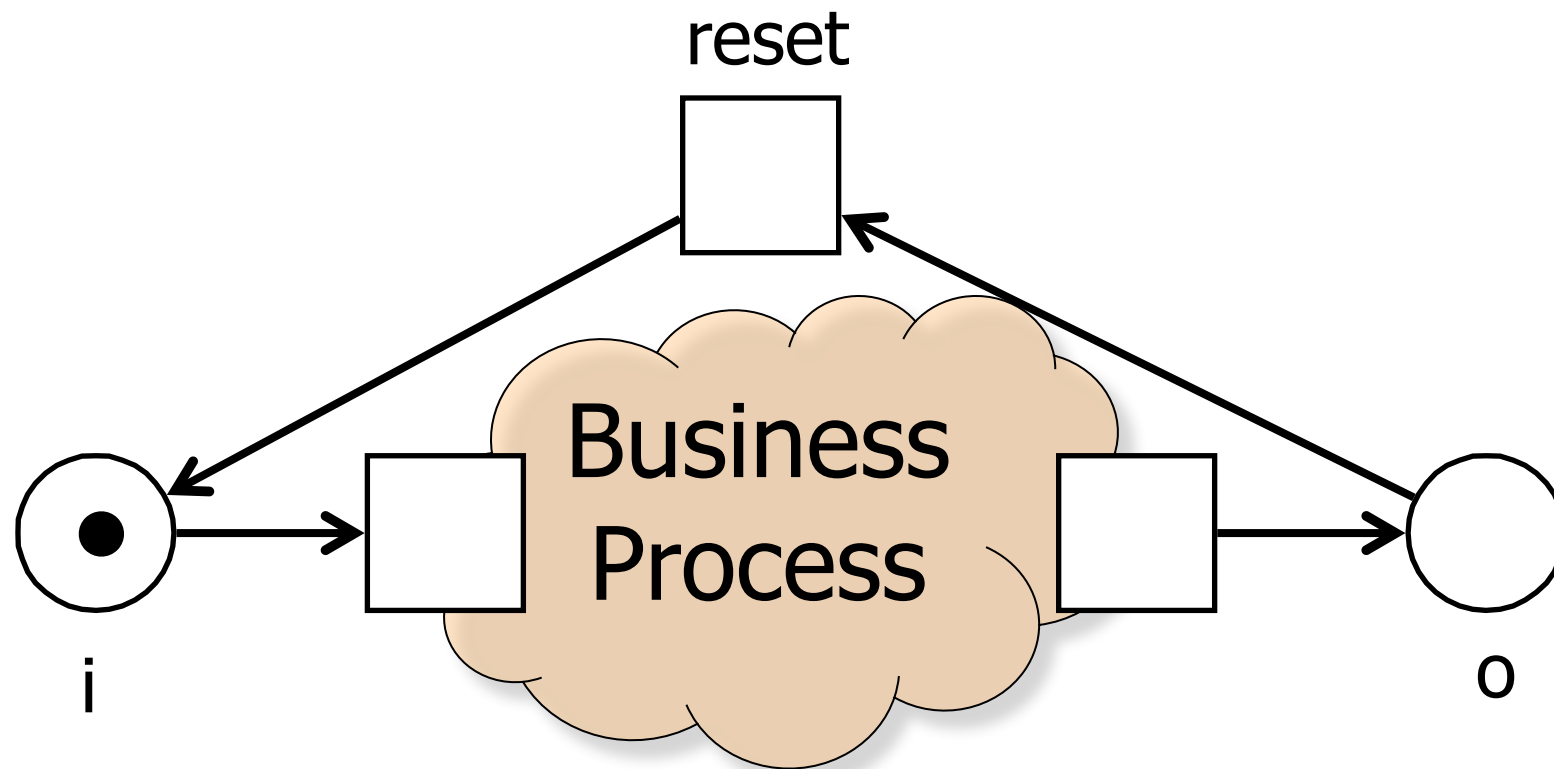

From N to N^*

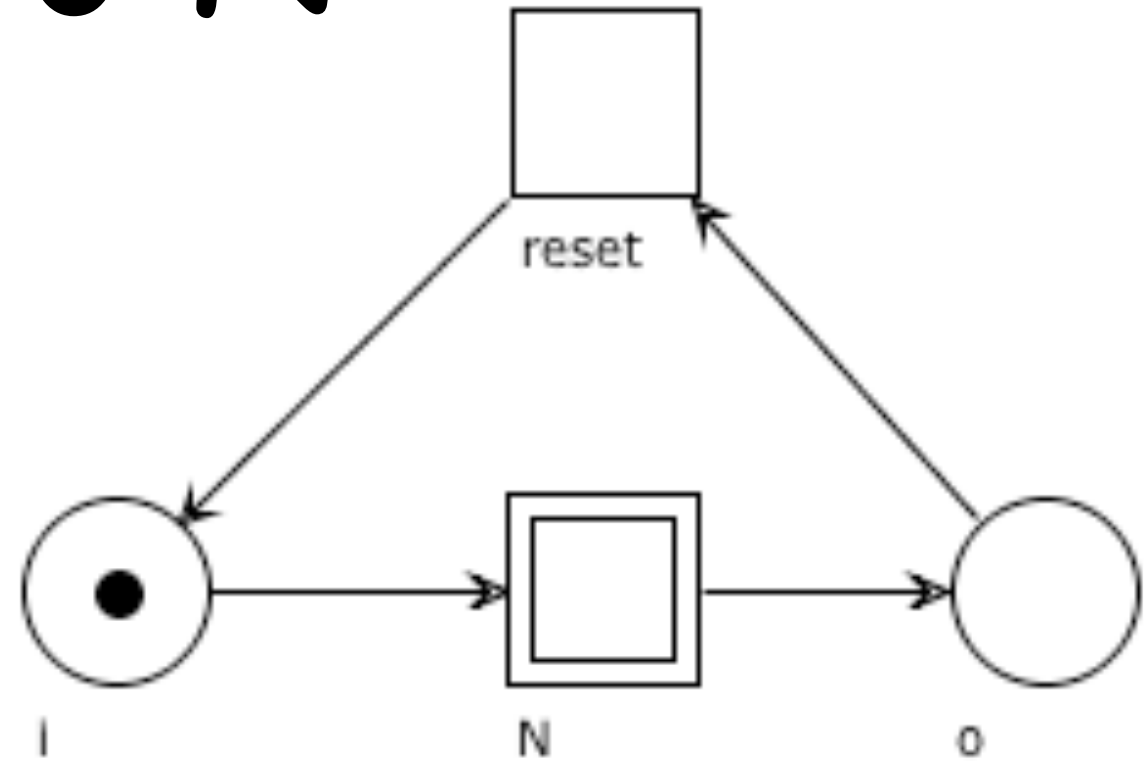
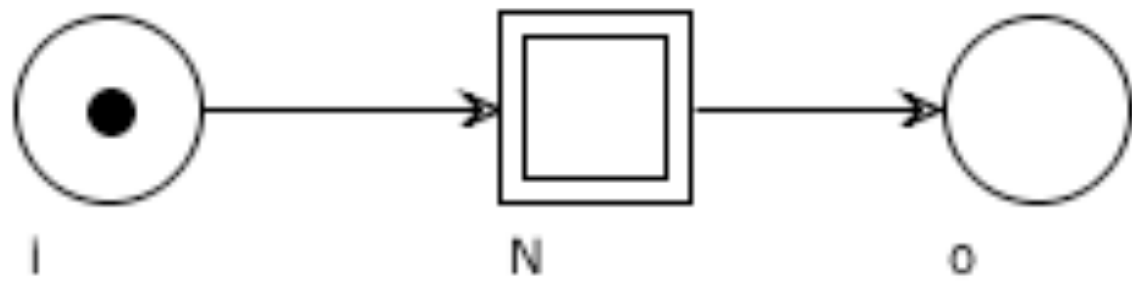

Let us denote by $N : i \rightarrow o$ a workflow net with entry place i and exit place o .

Let N^* be the net obtained by adding the “*reset*” transition to N
 $reset : o \rightarrow i$.

MAIN THEOREM

Theorem:

N is sound iff N^* is live and bounded

Proof of MAIN THEOREM (1)

N^* **live and bounded** implies N **sound**:

Since N^* is **live**: for each $t \in T$ there is $M \in [i \rangle$. $M \xrightarrow{t}$

Take any $M \in [i \rangle$ enabling $reset : o \rightarrow i$, hence $M \supseteq o$

Let $M \xrightarrow{reset} M'$. Then $M' \in [i \rangle$ and $M' \supseteq i$

Since N^* is bound, it must be $M' = i$ (and $M = o$)

Otherwise all places marked by $M' - i = M - o$ would be unbounded

Hence N^* just allows multiple runs of N :

"option to complete" and "proper completion" hold (see above)

"no dead task" holds because N^* is live

A technical lemma

Lemma:

If N is sound, M is reachable in N iff M is reachable in N^*

\Rightarrow) straightforward

\Leftarrow) Let $i \xrightarrow{\sigma} M$ in N^* for $\sigma = t_1 t_2 \dots t_n$

We proceed by induction on the number r of instances of *reset* in σ

If $r = 0$, then *reset* does not occur in σ and M is reachable in N

If $r > 0$, let k be the least index such that $t_k = \text{reset}$

Let $\sigma = \sigma' t_k \sigma''$ with $\sigma' = t_1 t_2 \dots t_{k-1}$ fireable in N

Since N is sound: $i \xrightarrow{\sigma'} o$ and $i \xrightarrow{\sigma''} M$

Since σ'' contains $r - 1$ instances of *reset*:

by inductive hypothesis M is reachable in N

Proof of MAIN THEOREM (2)

N sound implies N^* bounded :

We proceed by contradiction, assuming N^* is unbounded

Since N^* is unbounded:

$\exists M, M'$ such that $i \rightarrow^* M \rightarrow^* M'$ with $M \subset M'$

Let $L = M' - M \neq \emptyset$

Since N is sound:

$\exists \sigma \in T^*$ such that $M \xrightarrow{\sigma} o$

By the monotonicity Lemma: $M' \xrightarrow{\sigma} o + L$ and thus $o + L \in [i \rangle$

Which is absurd, because N is sound

Proof of MAIN THEOREM (3)

N sound implies N^* live:

Take any transition t and let M be a marking reachable in N^*

By the technical lemma, M is reachable in N

Since N is sound: $\exists \sigma \in T^*$ with $M \xrightarrow{\sigma} o$

Since N is sound: $\exists \sigma' \in T^*$ with $i \xrightarrow{\sigma'} M'$ and $M' \xrightarrow{t}$

Let $\sigma'' = \sigma$ reset σ' , then:

$M \xrightarrow{\sigma''} M'$ in N^* and $M' \xrightarrow{t}$

Recall: consequences of strong connectedness theorem

If a (weakly-connected) net is not strongly connected
then

It is not “live and bounded”

If it is live, it is not bounded

If it is bounded, it is not live

Strong connectedness of N^*

Proposition:

N^* is strongly connected.

Take two nodes of $(x, y) \in F_{N^*}$,
we want to build a path from y to x

If $x, y \neq reset$, then

y lies on a path $i \rightarrow^* \boxed{y \rightarrow^* o}$, because N is a workflow net,
 x lies on a path $\boxed{i \rightarrow^* x} \rightarrow^* o$, because N is a workflow net,
 we combine the paths $y \rightarrow^* o \rightarrow reset \rightarrow i \rightarrow^* x$

If $x = o, y = reset$, then
 take any path $i \rightarrow^* o$,

we build the path $reset \rightarrow i \rightarrow^* o$

If $x = reset, y = i$, then
 take any path $i \rightarrow^* o$,
 we build the path $i \rightarrow^* o \rightarrow reset$

Strong connectedness of N^* : example

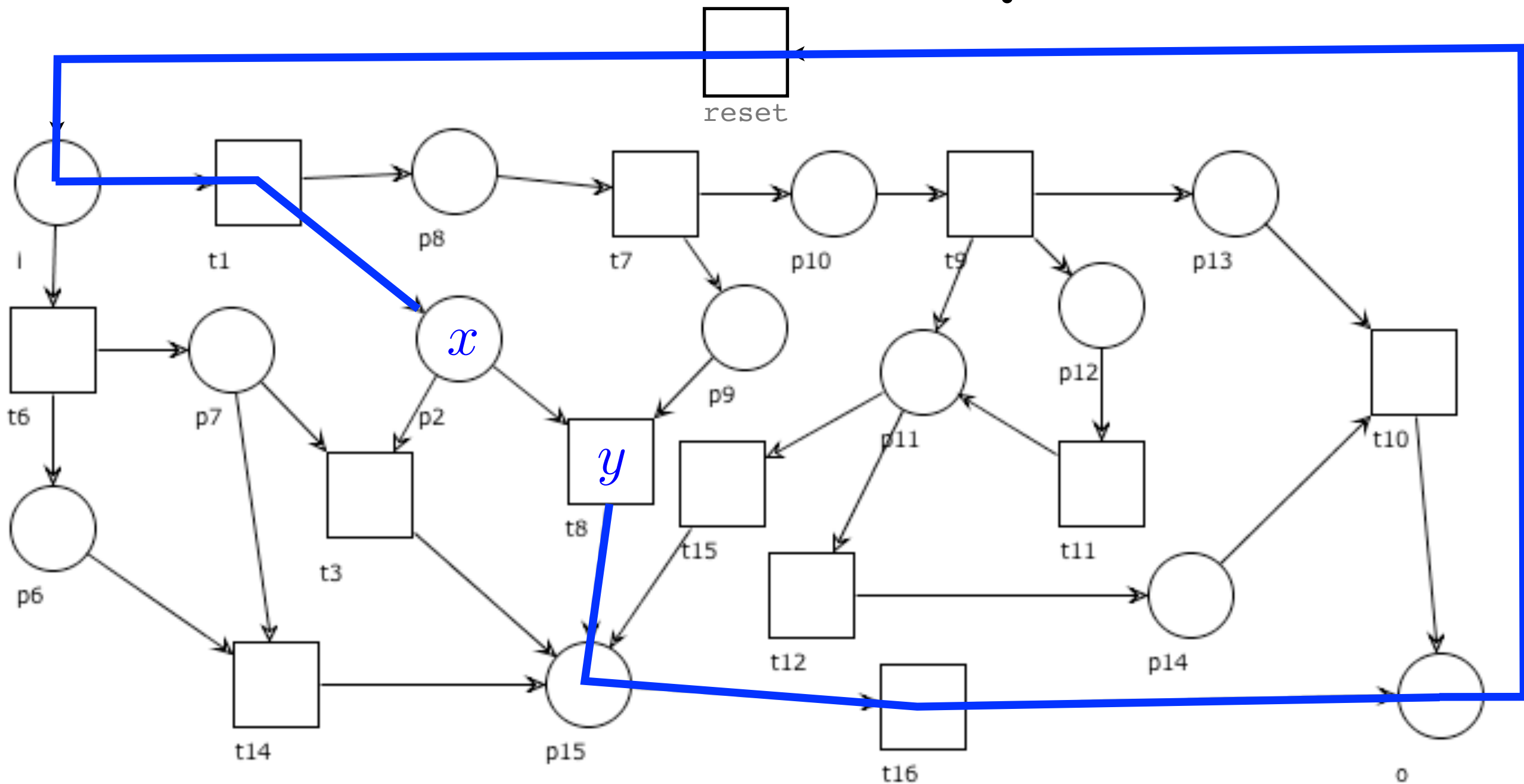

<http://woped.dhbw-karlsruhe.de/woped/>

WoPeD (3.7.1)

Workflow Petri Net Designer

Download WoPeD at sourceforge!

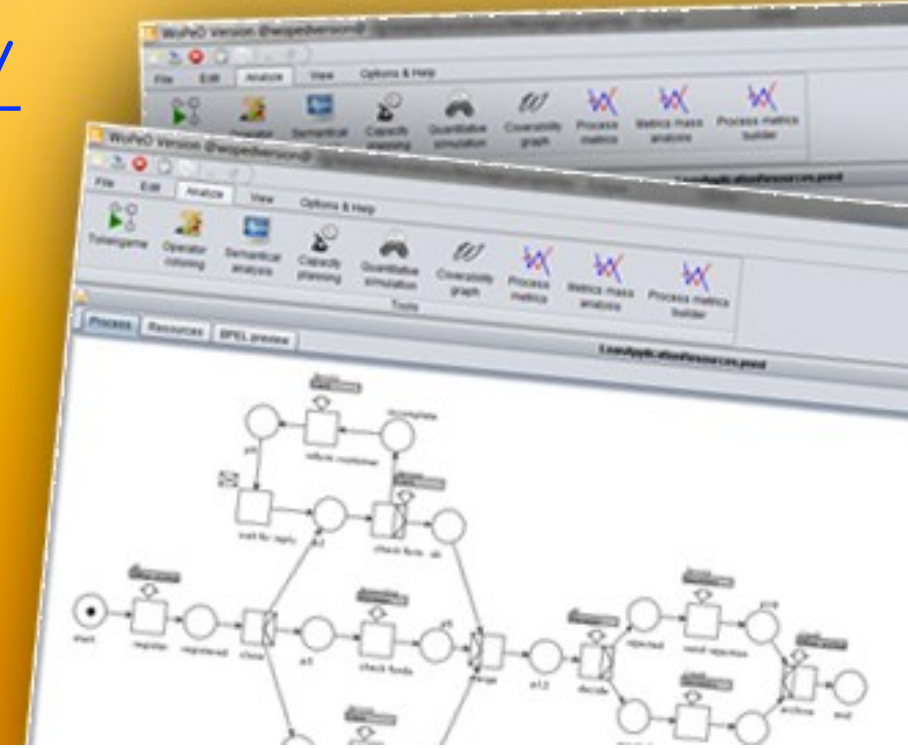

WoPeD 3.2.0

File Edit Analysis Simulation Help Community

Task engine Open color Semantic analysis Party planning Quantitative simulation Coverability graph Show matrix Petri net mass analysis Petri net builder

Process Resources SPDL preview

Horizontal zoom: 100%

Save

Exercise

Use some tools to check if the net below is a sound workflow net or not

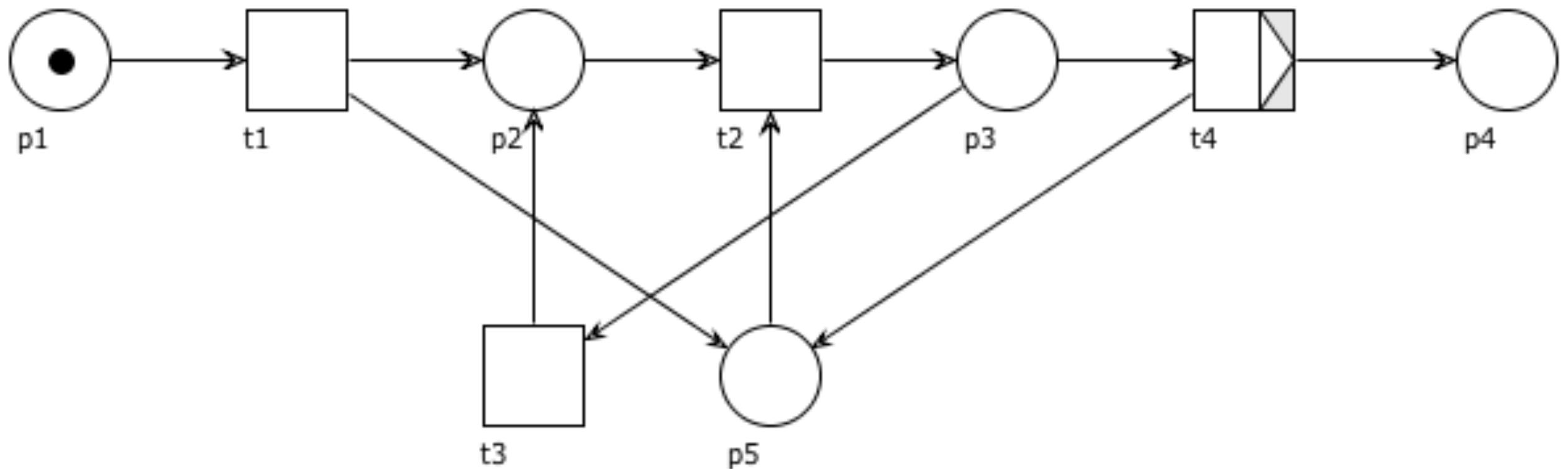

Exercise

Use some tools to check if the net below is a sound workflow net or not

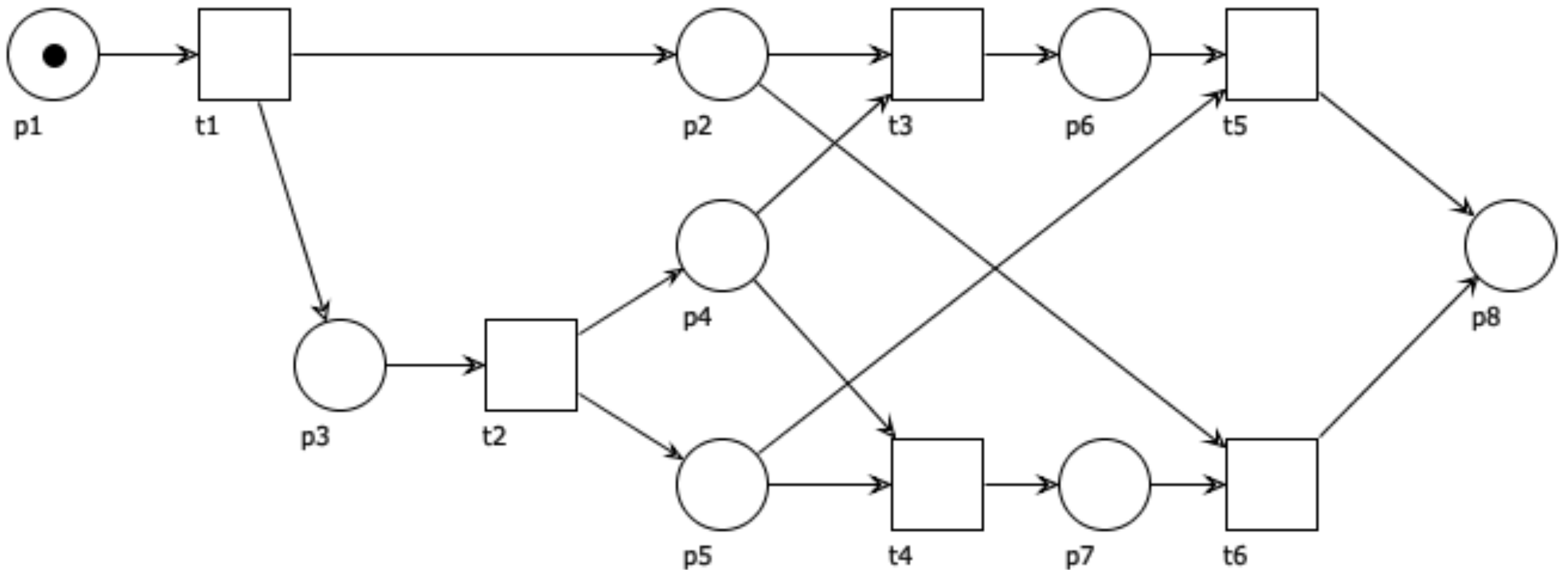

Exercise

Analyse the following net

