

Business Processes Modelling

MPB (6 cfu, 295AA)

Roberto Bruni

<http://www.di.unipi.it/~bruni>

15 - Sound by construction



Object



We show a technique to build sound
Workflow nets

Soundness proof by construction

Idea

1. Find a suitable set of "building blocks"

they are (small) workflow nets
that can be (easily) proved
to be **sound** and
to be **safe** (1-bounded)

2. Define composition patterns so that
by composing **safe and sound** WF nets
we get **safe and sound** WF nets

Sound and safe by composition

Let N , N' be two safe and sound workflow nets

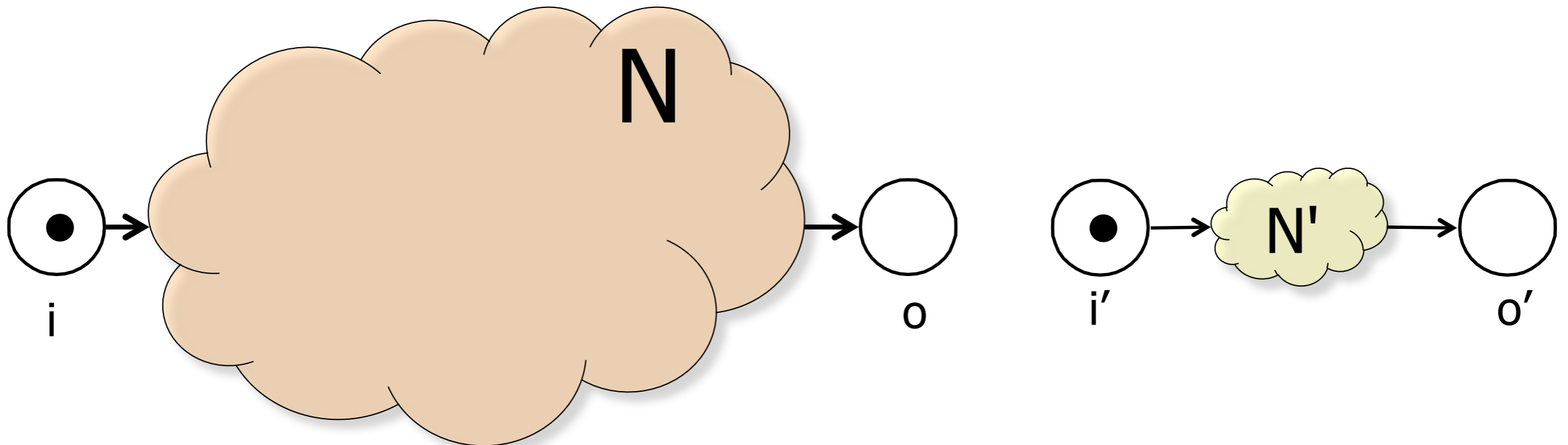

Sound and safe by composition

Let t be a task of N with exactly one input and one output place

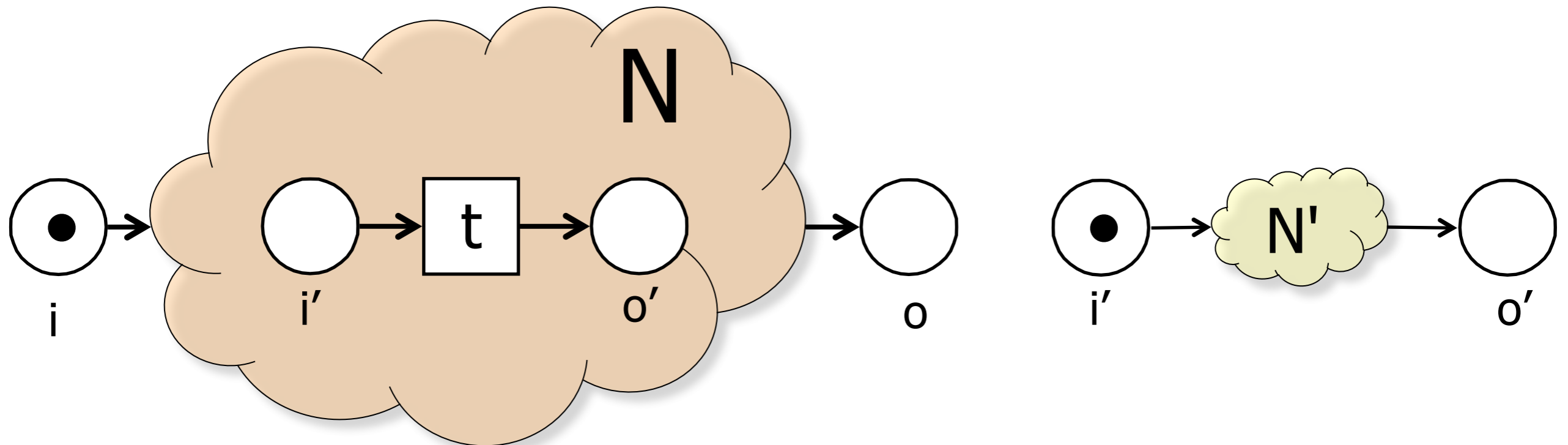

Sound and safe by composition

Let $N[N'/t]$ denote the net obtained by replacing the task t in N by N'

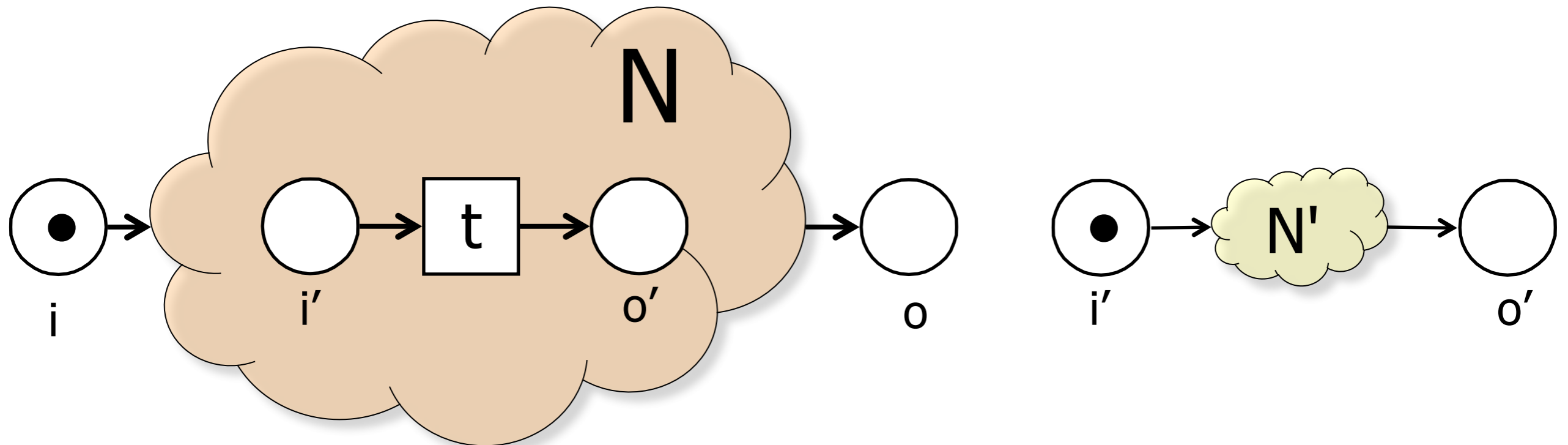

Sound and safe by composition

Let $N[N'/t]$ denote the net obtained by replacing the task t in N by N'

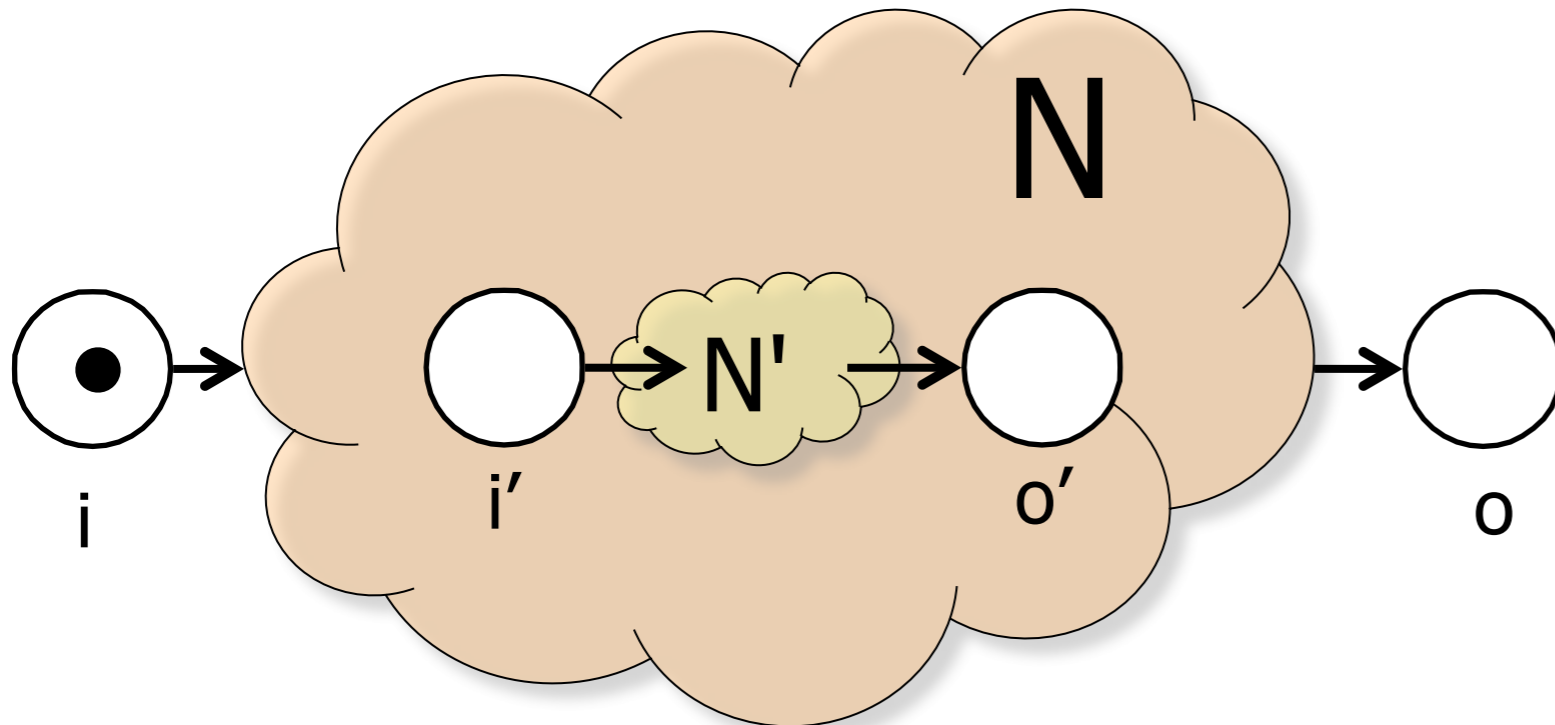

Sound and safe by composition

The net $N[N'/t]$ is
a **sound and safe workflow net**
(proof omitted)

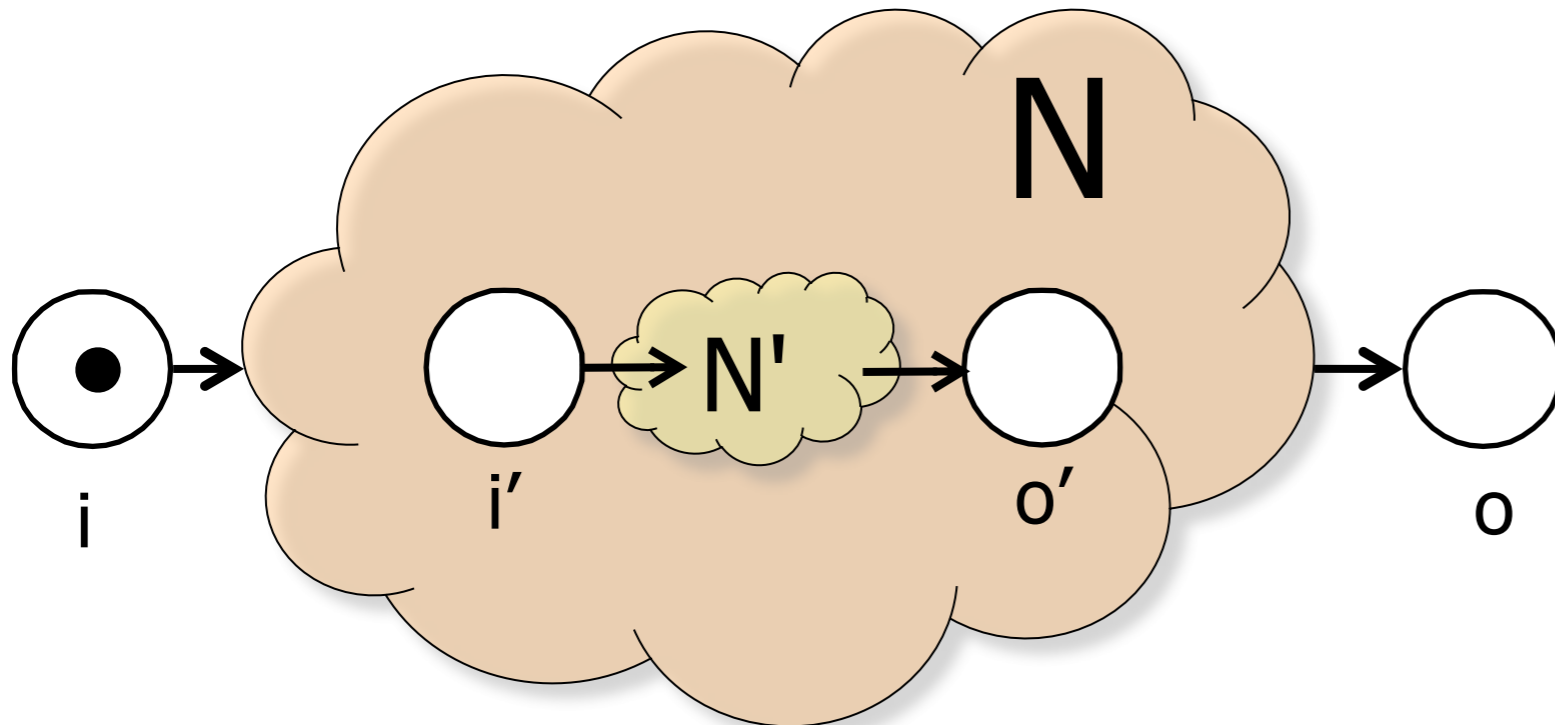

Proof sketch

Intuitively

a sound workflow net behaves as a transition:
it takes one token from its input place and
it produces one token to its output place
(but not atomically)

Formally

the crux of the proof is showing a bijective correspondence
between

markings of the composed net $N[N'/t]$
and the pairs of markings in N and N'

Some Building Blocks 1

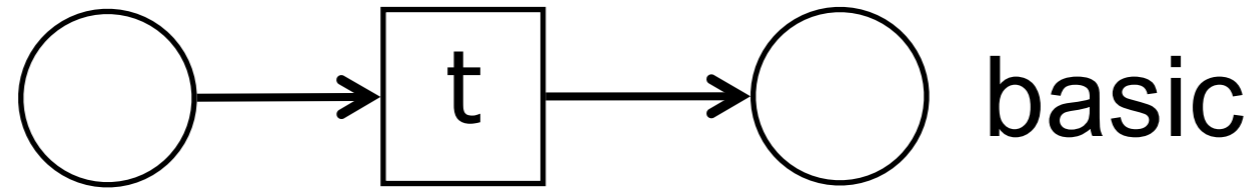

Some Building Blocks 1

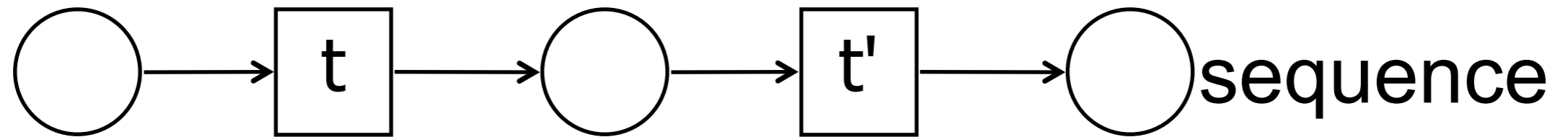
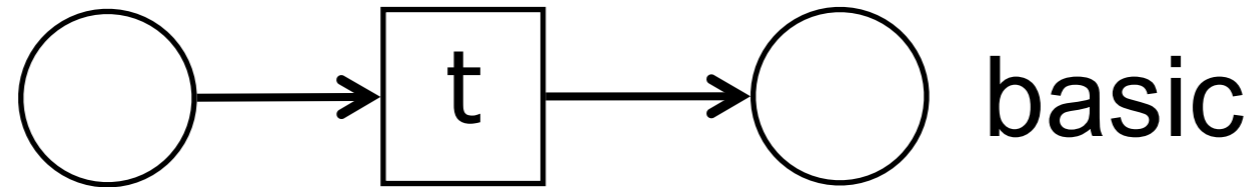

Some Building Blocks 1

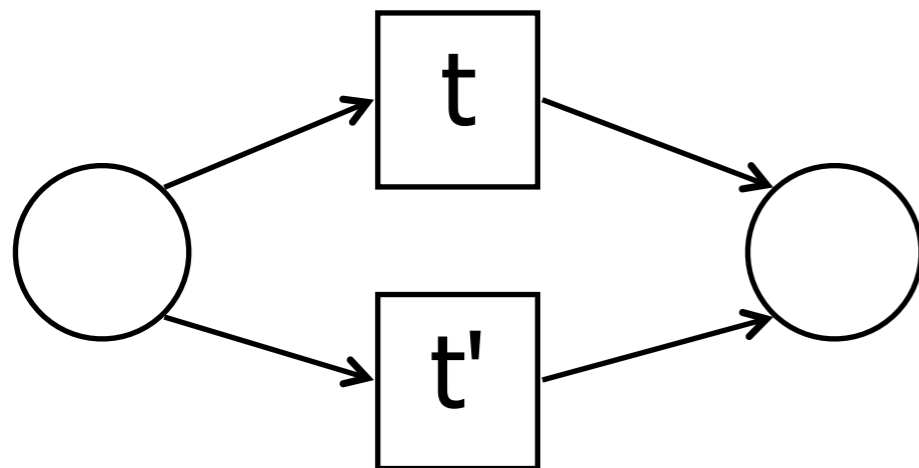
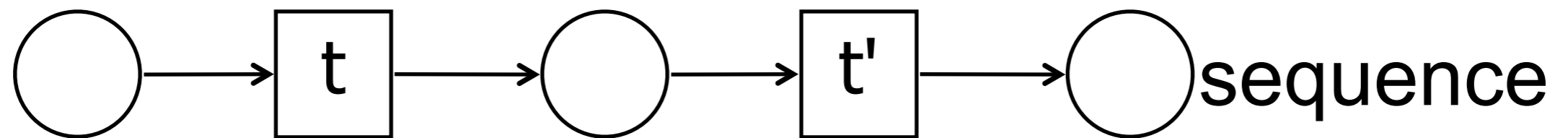
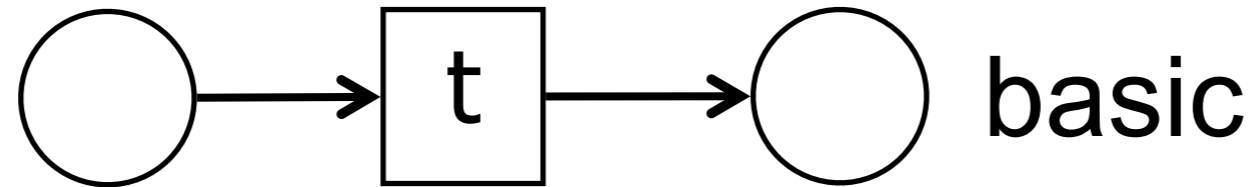

implicit XOR

Some Building Blocks 1

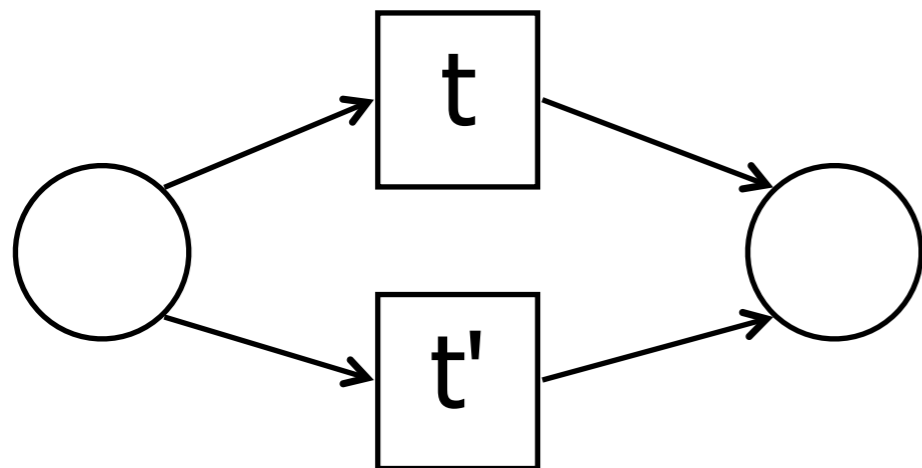
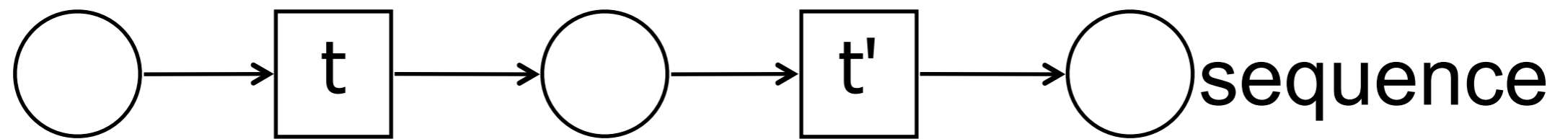
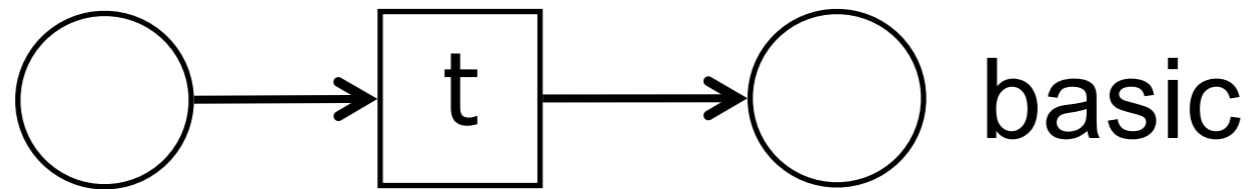

implicit XOR

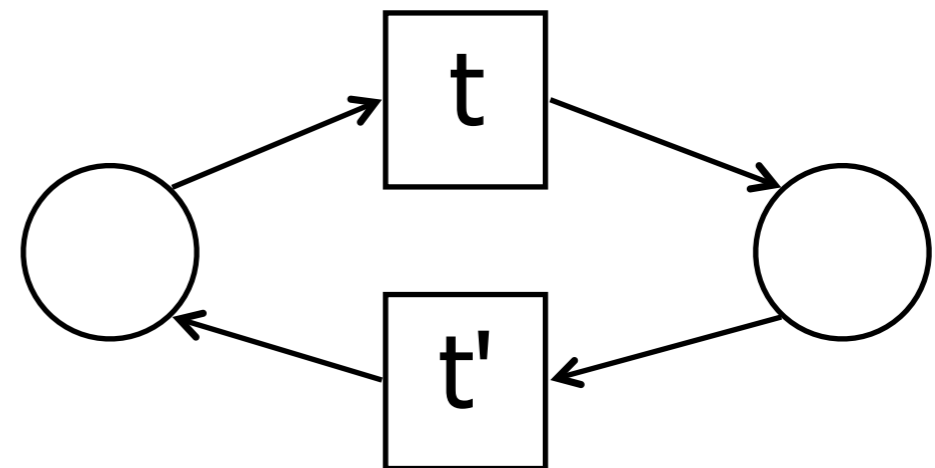

iteration

Some Building Blocks 1

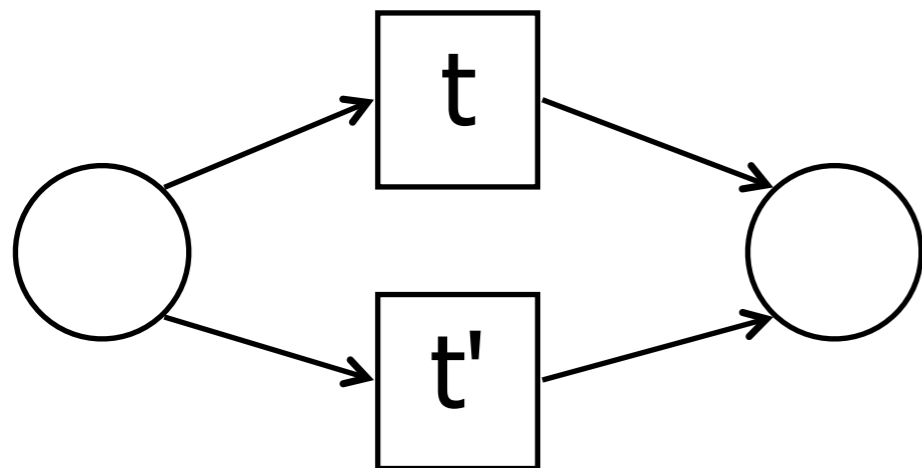
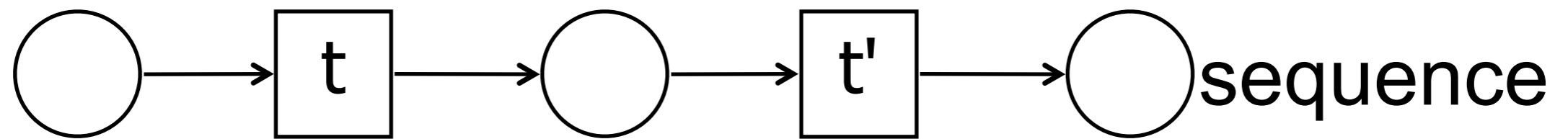
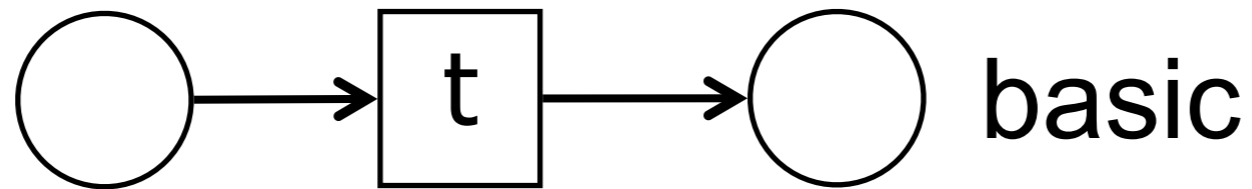

implicit XOR

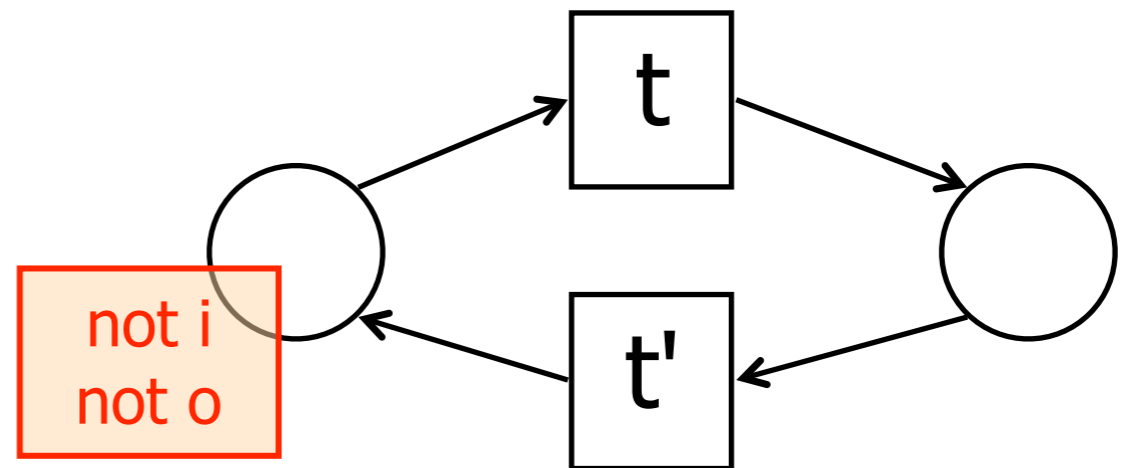

iteration

Some Building Blocks 1

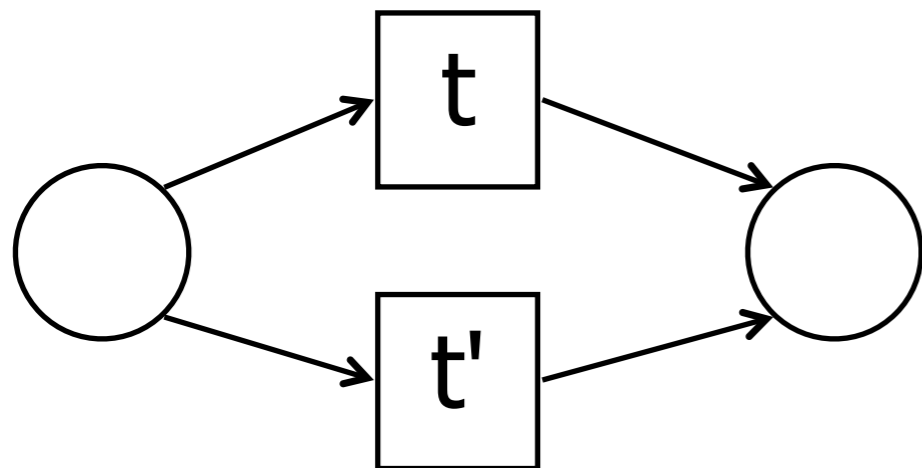
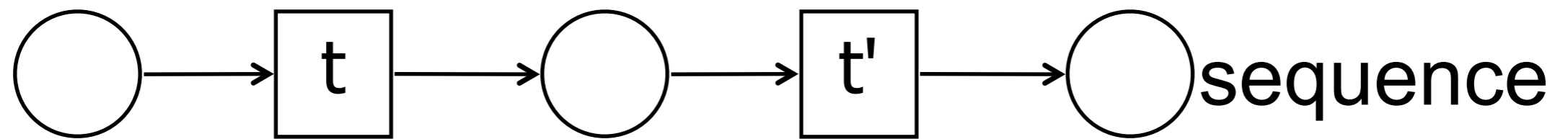
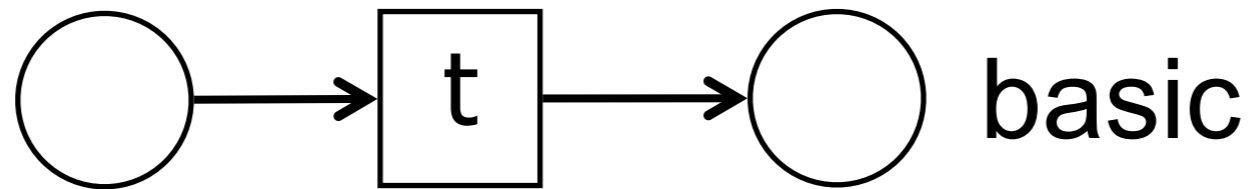

implicit XOR

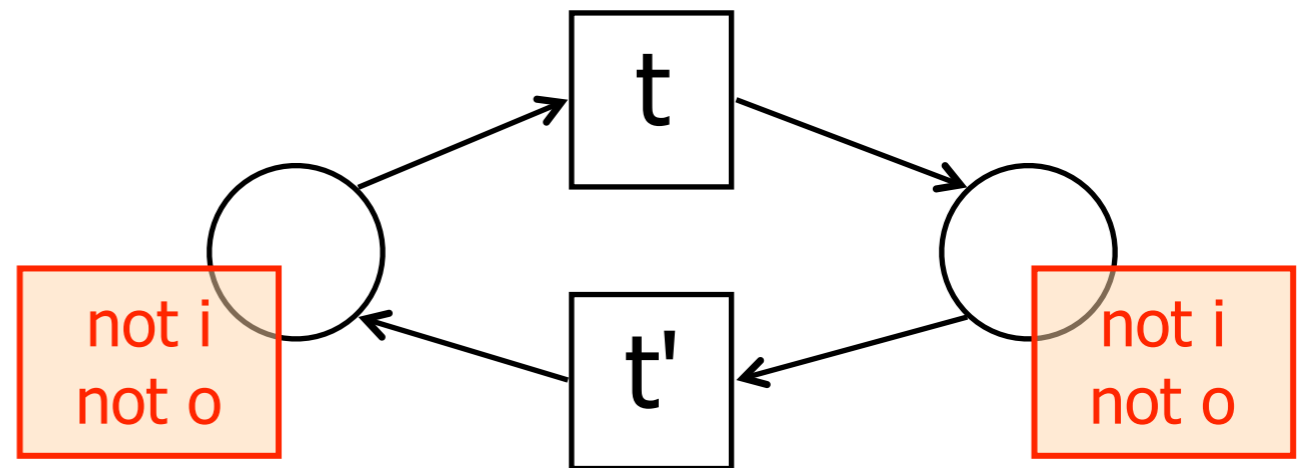

iteration

Some Building Blocks 2

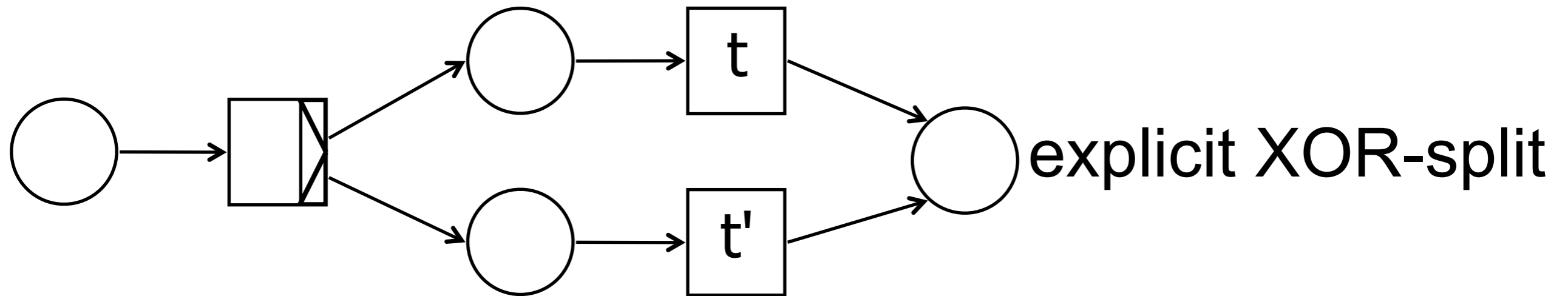

Some Building Blocks 2

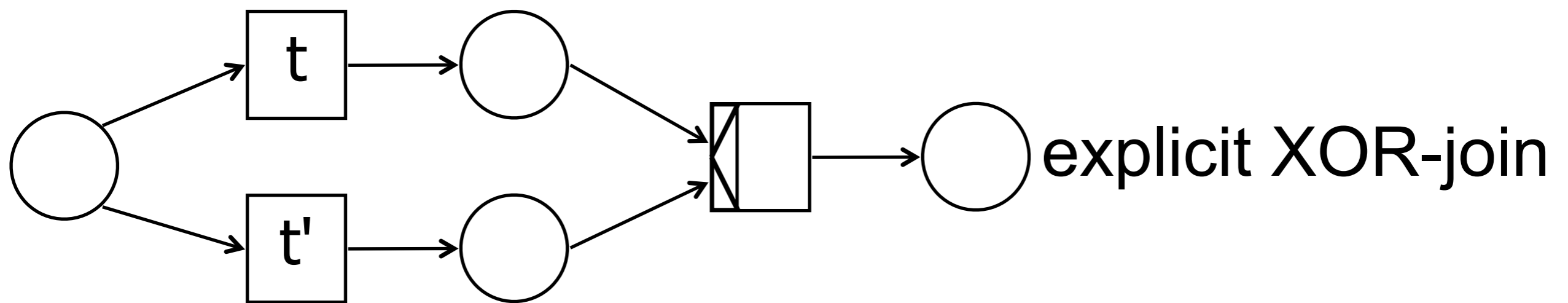
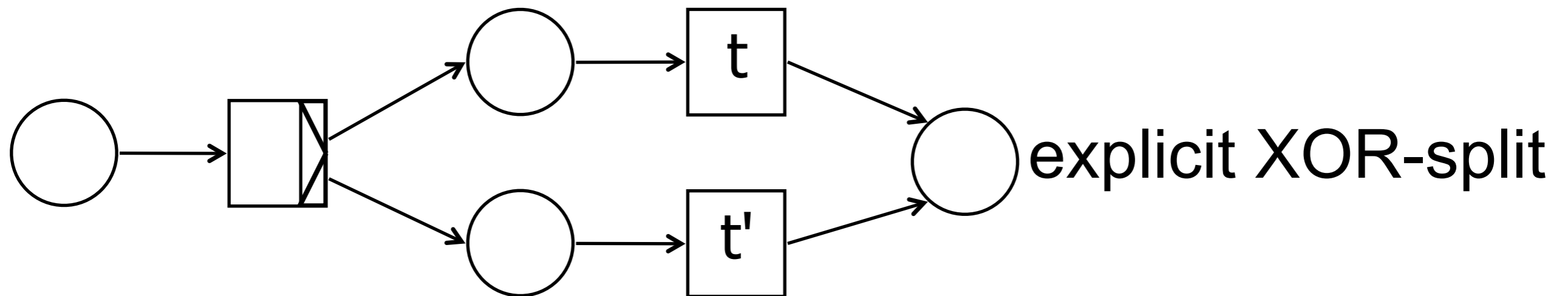

Some Building Blocks 3

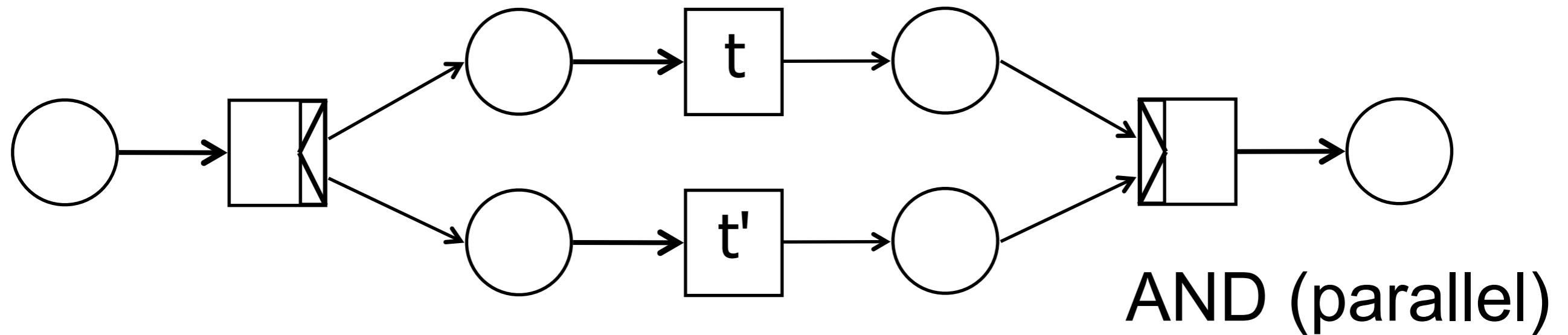

But you can define more blocks on your own

Example: refinement

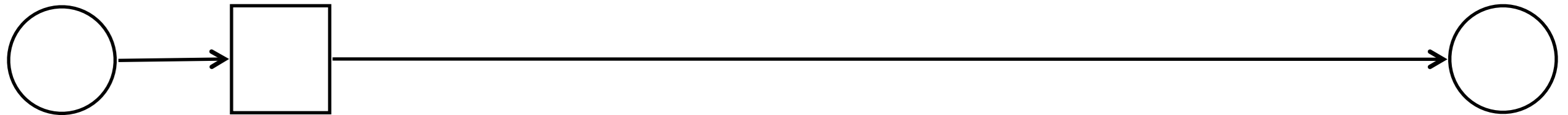

Example: refinement

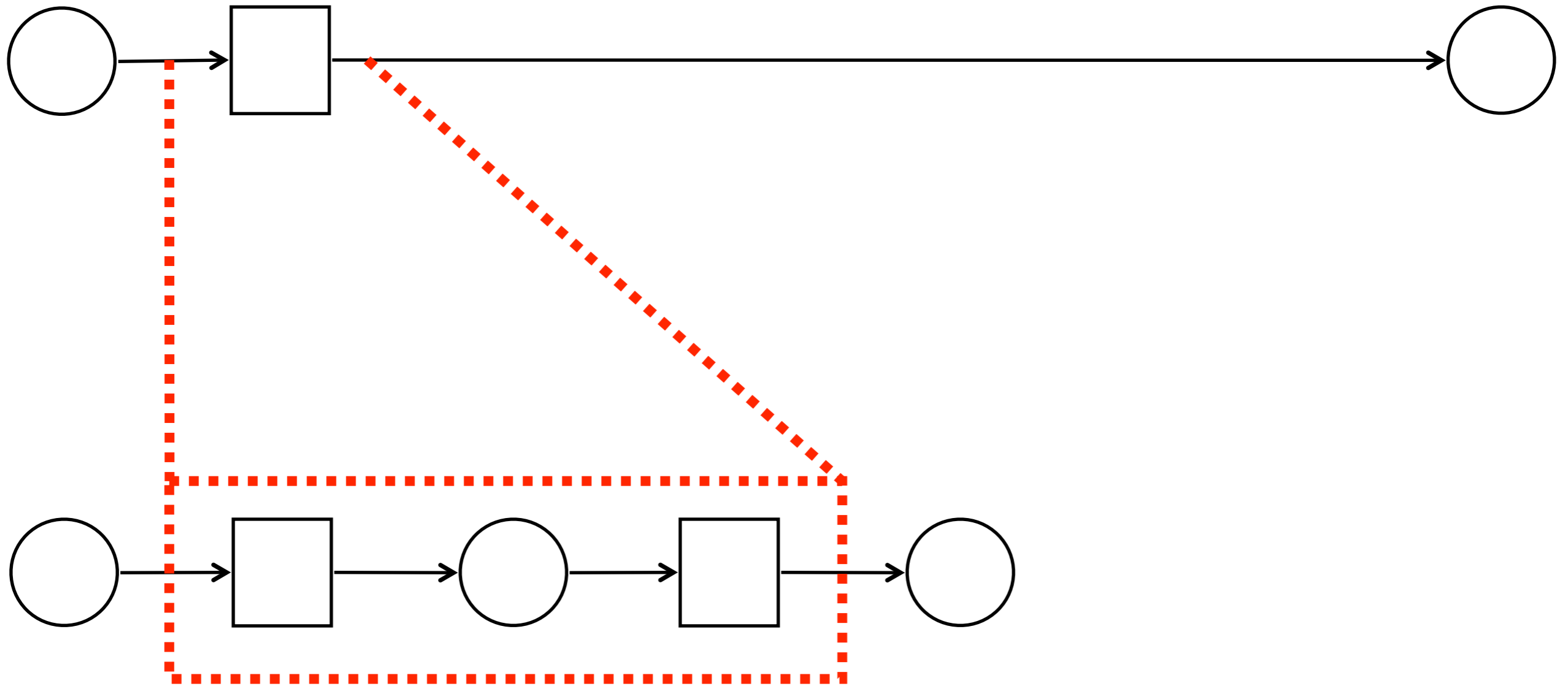

Example: refinement

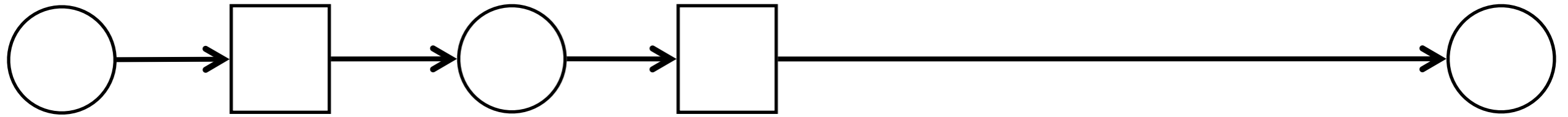

Example: refinement

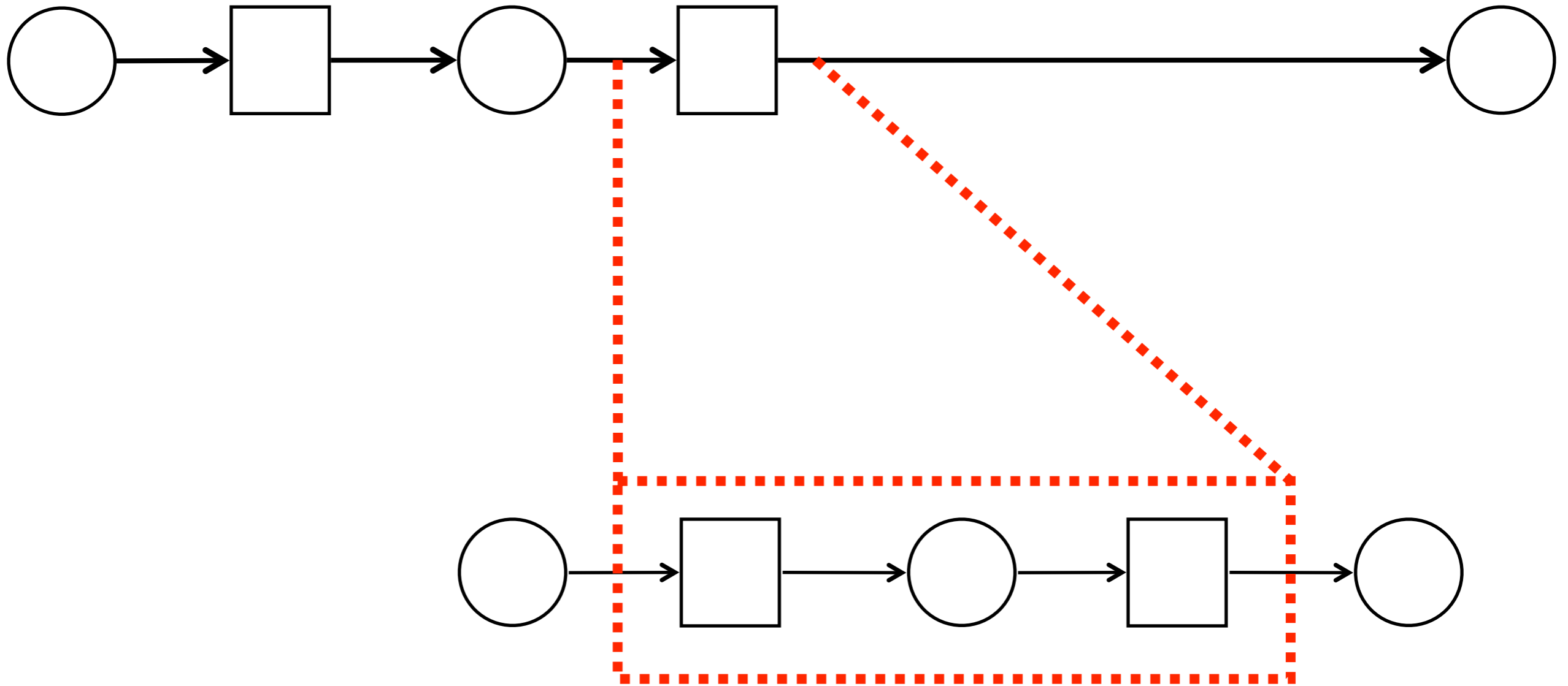

Example: refinement

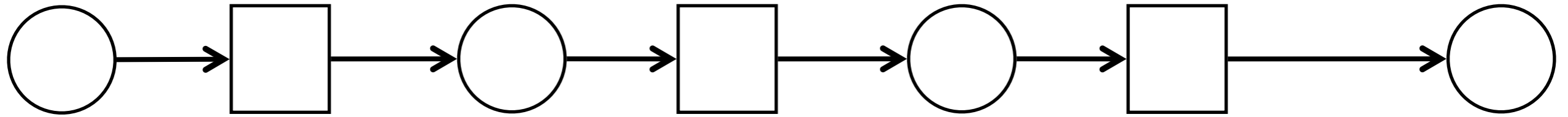

Example: refinement

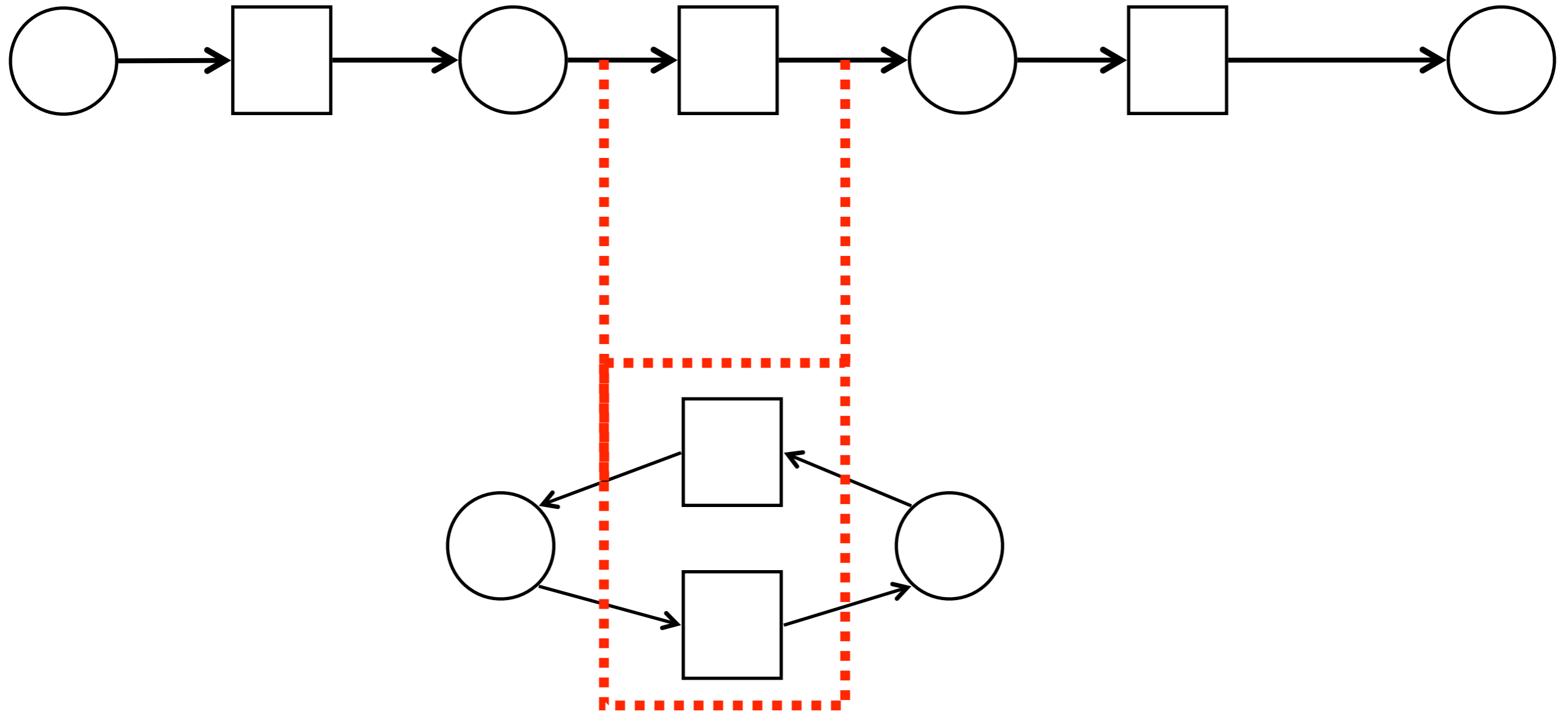

Example: refinement

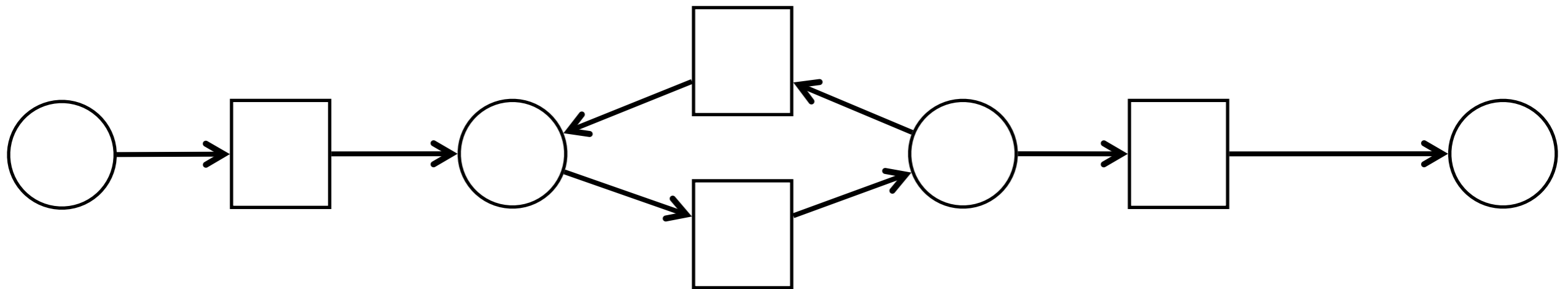

Example: refinement

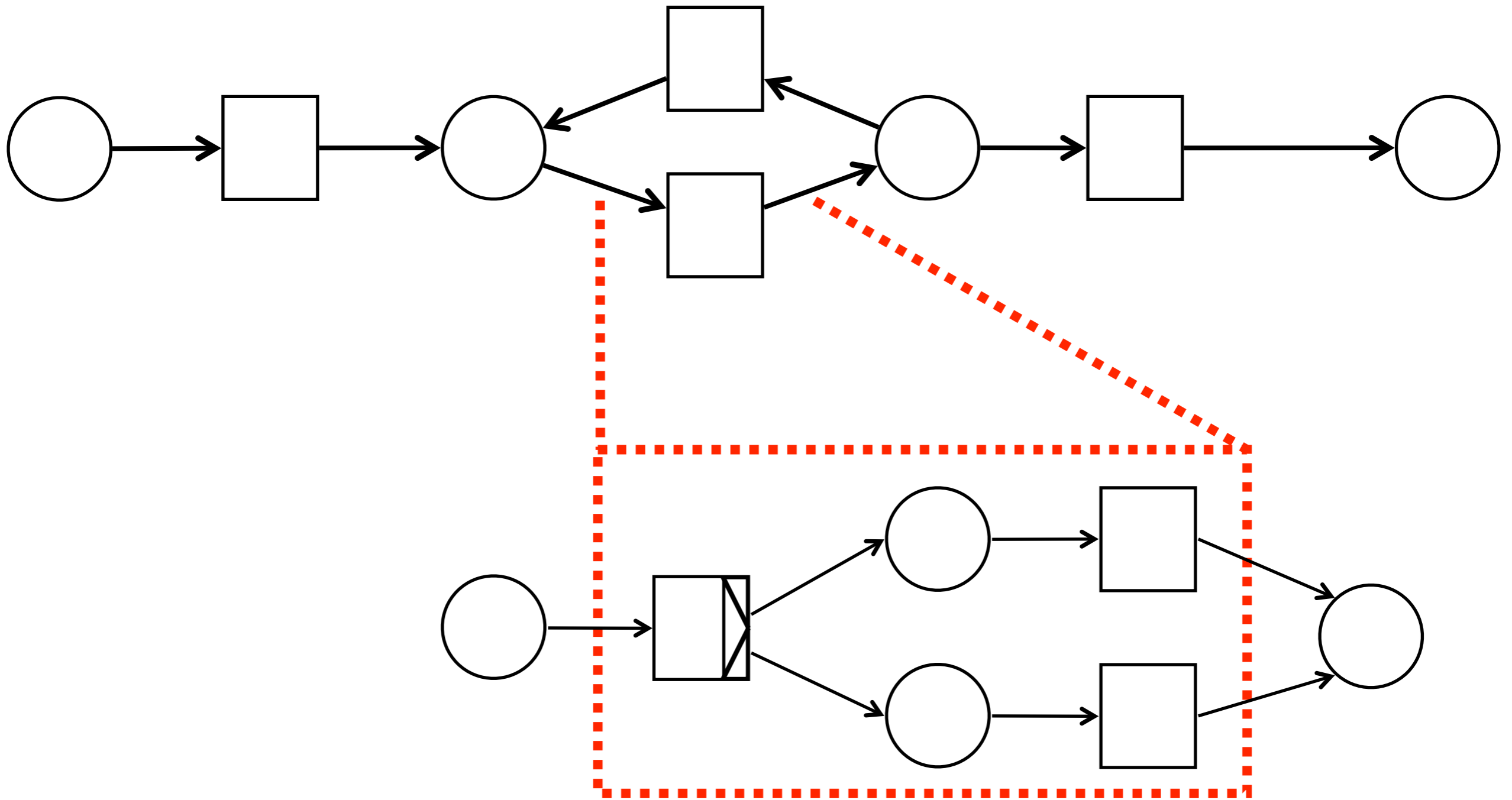

Example: refinement

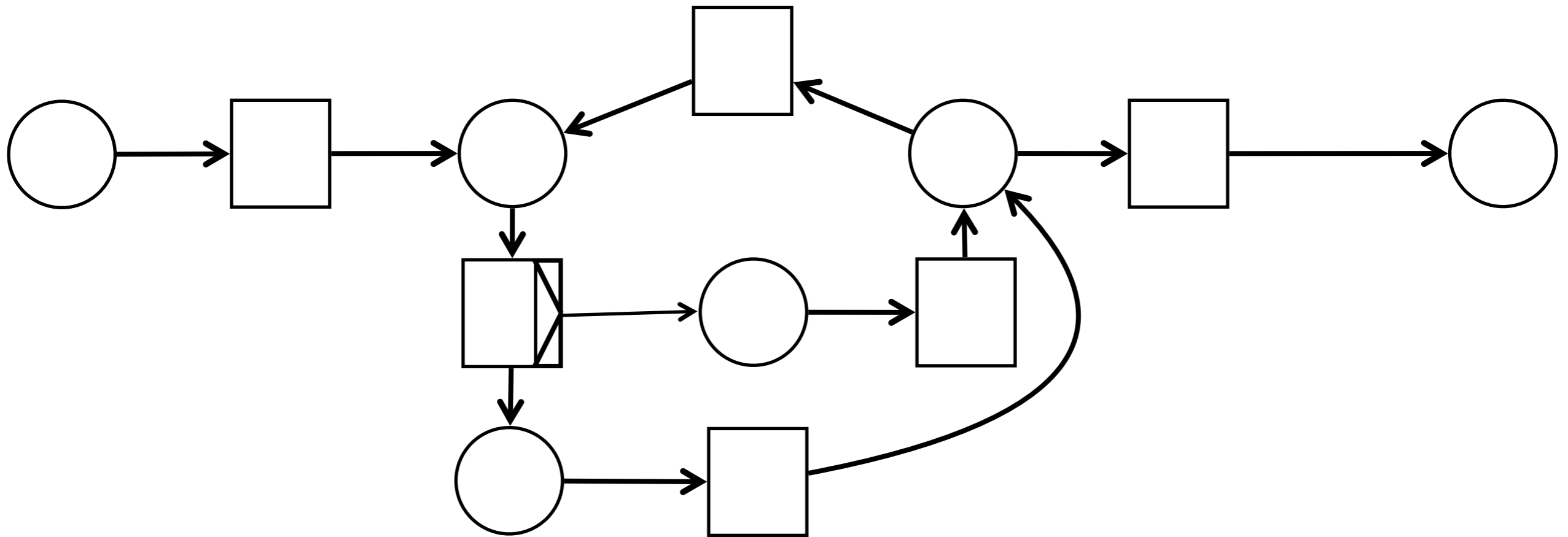

Example: refinement

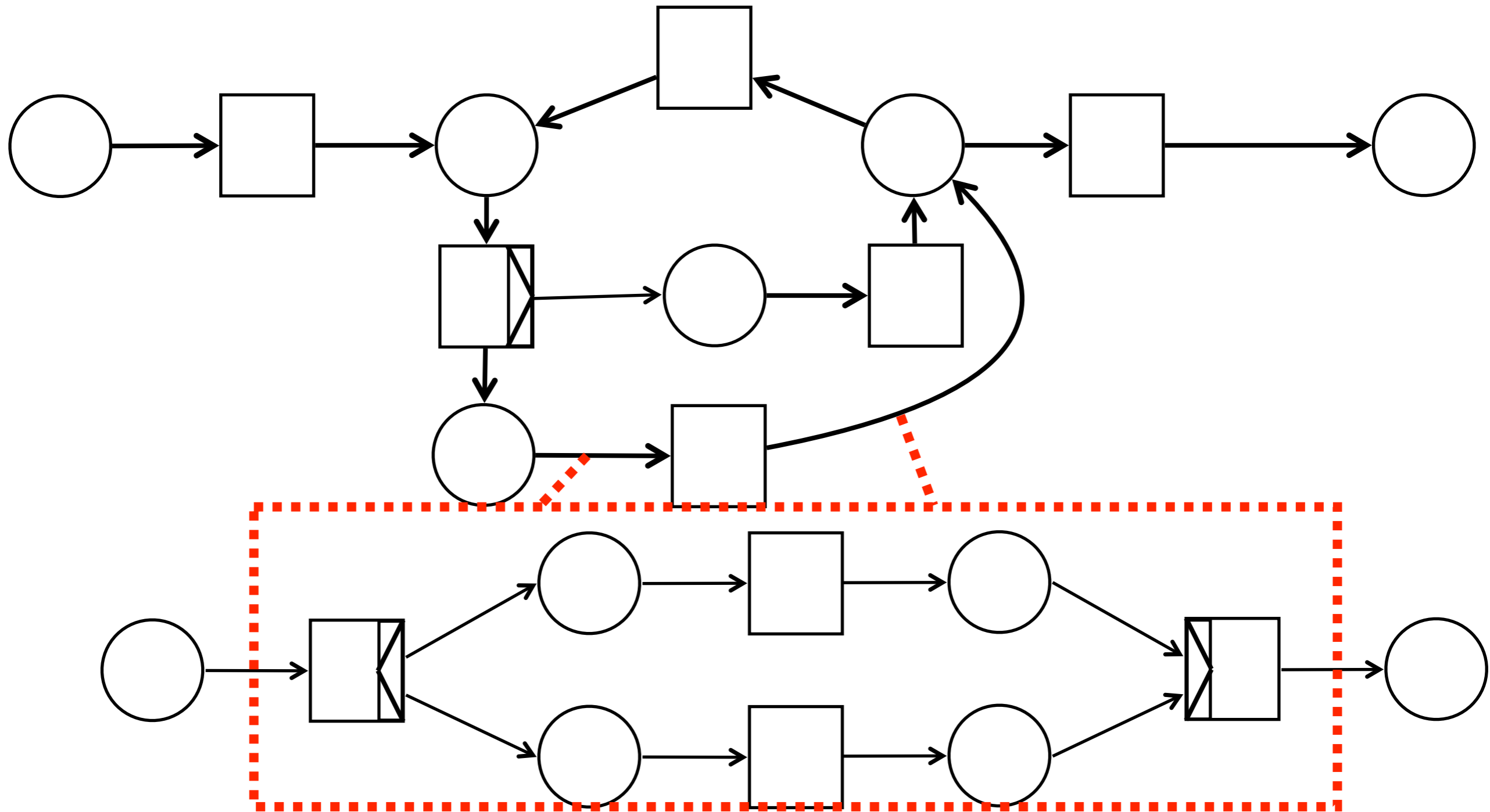

Example: refinement

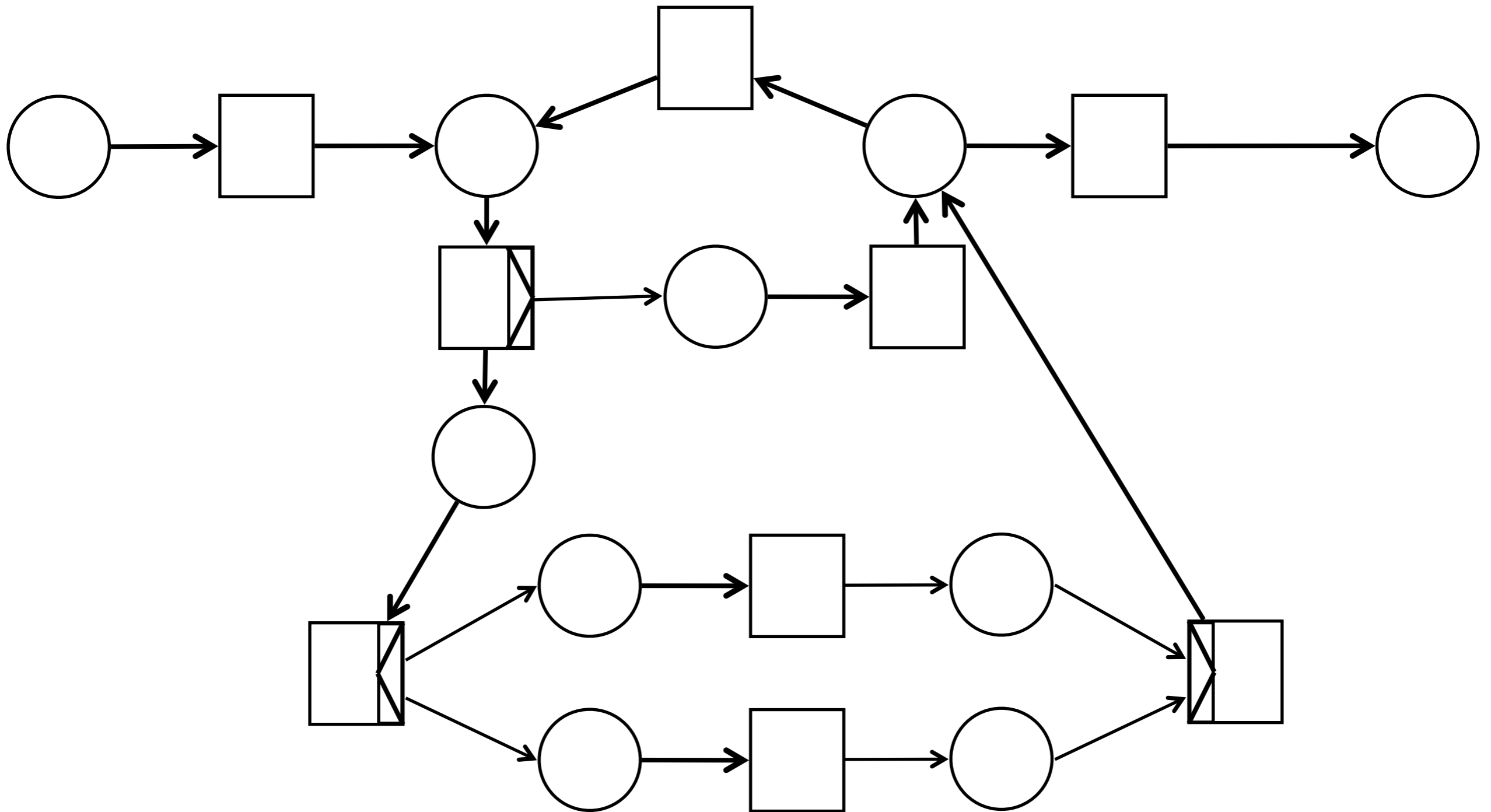

Example: abstraction

Prove that the net below is
a safe and sound workflow net

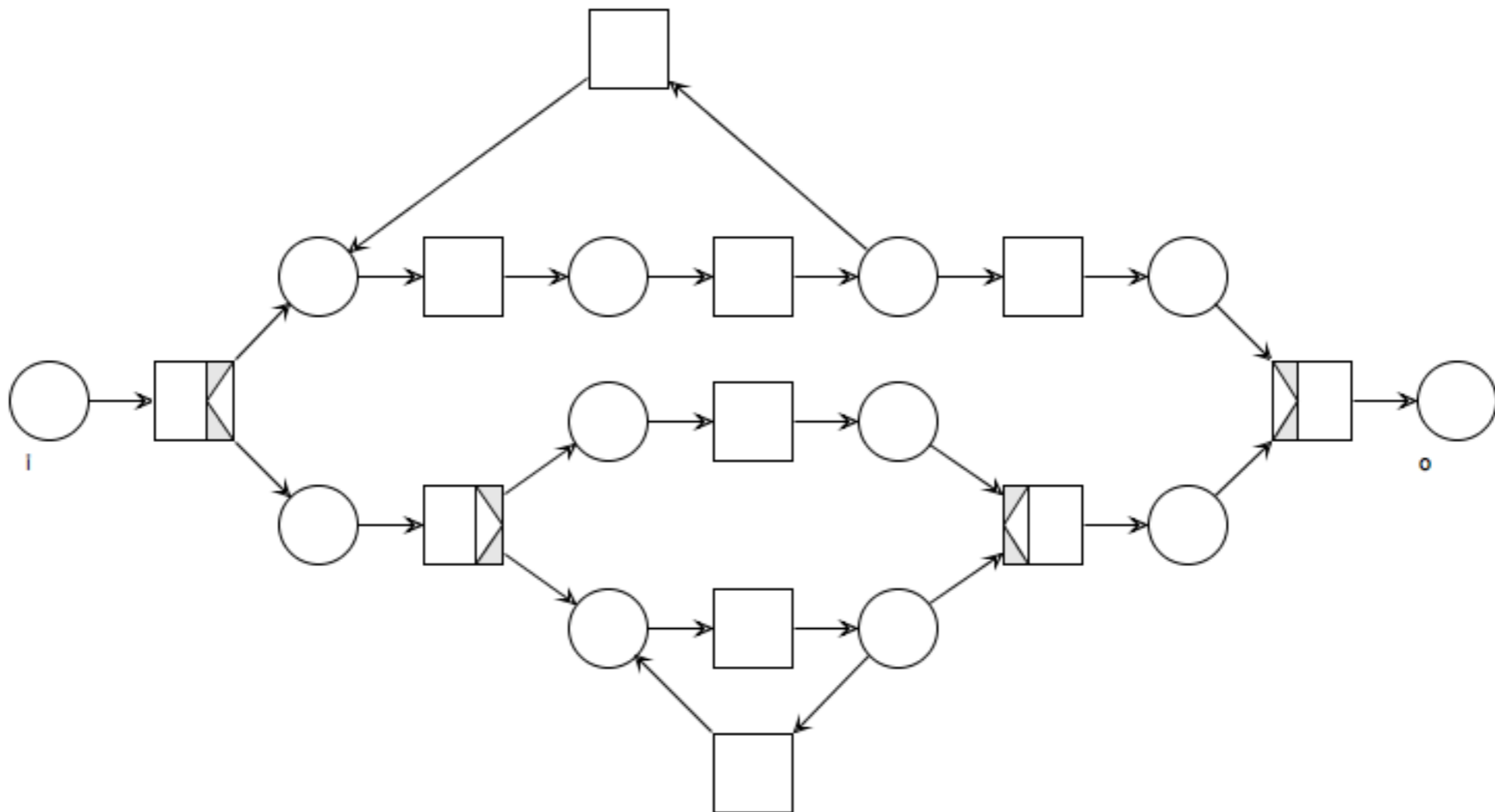

Example: abstraction

Prove that the net below is
a safe and sound workflow net

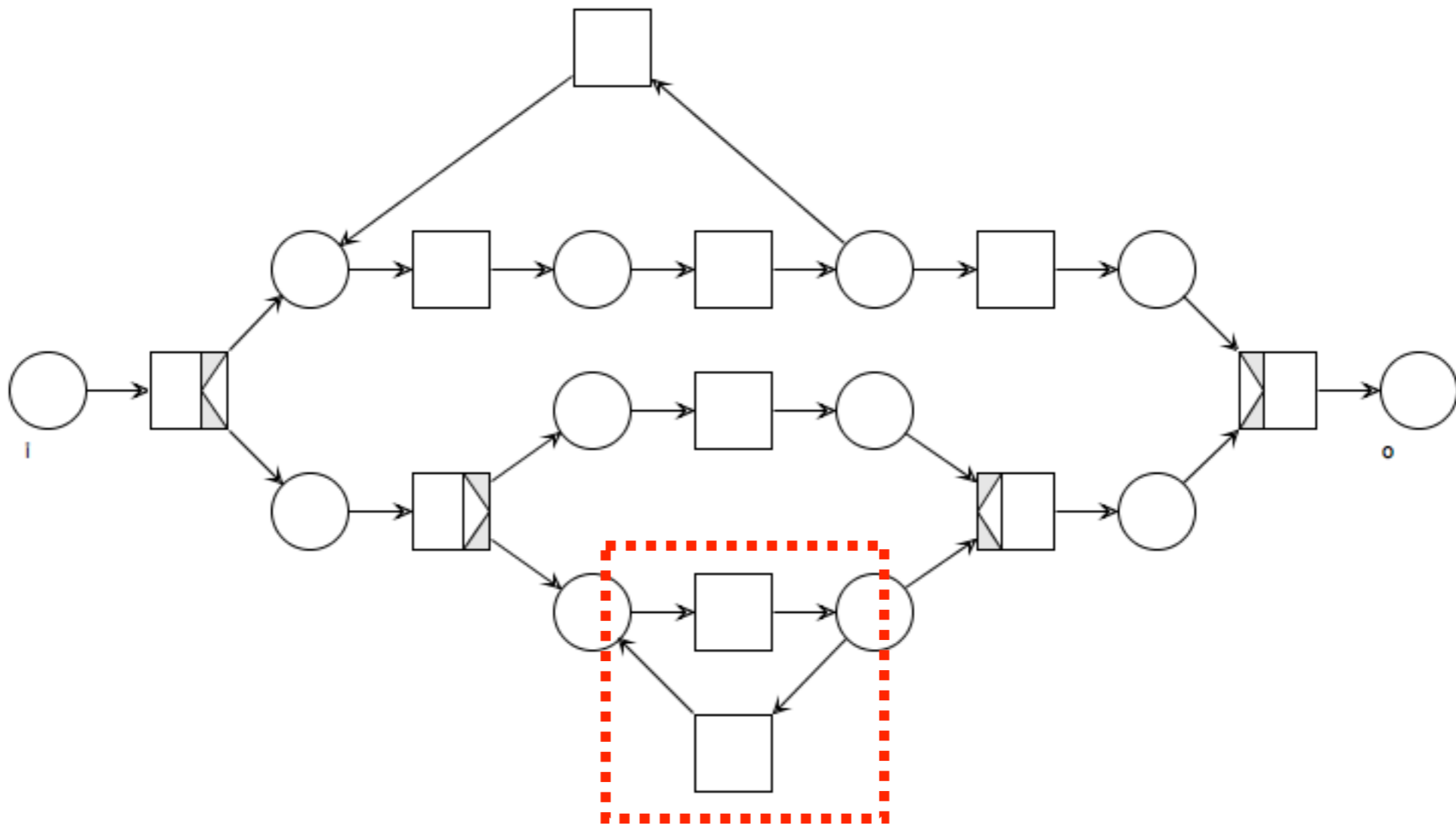

Example: abstraction

Prove that the net below is
a safe and sound workflow net

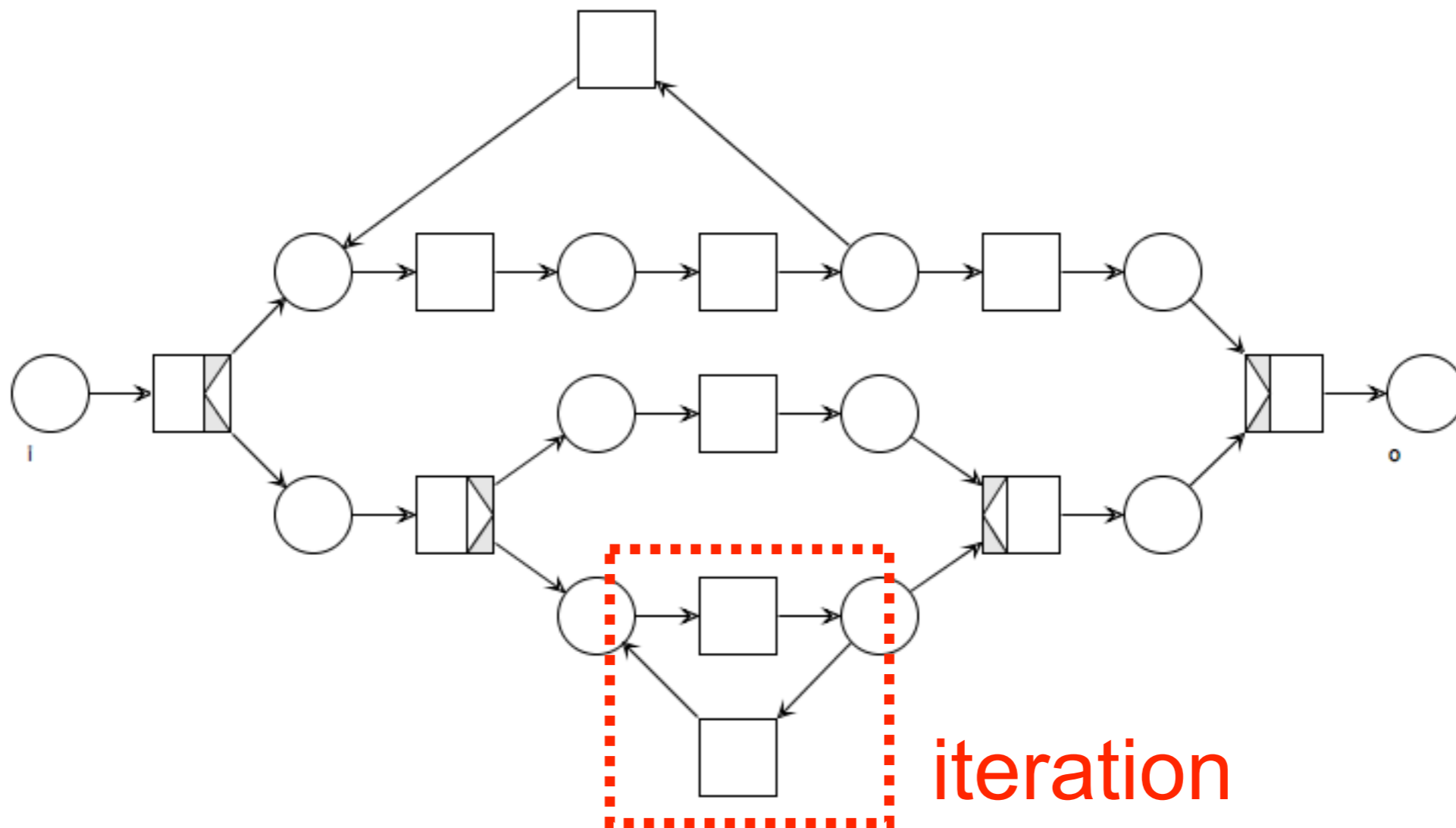

Example: abstraction

Prove that the net below is
a safe and sound workflow net

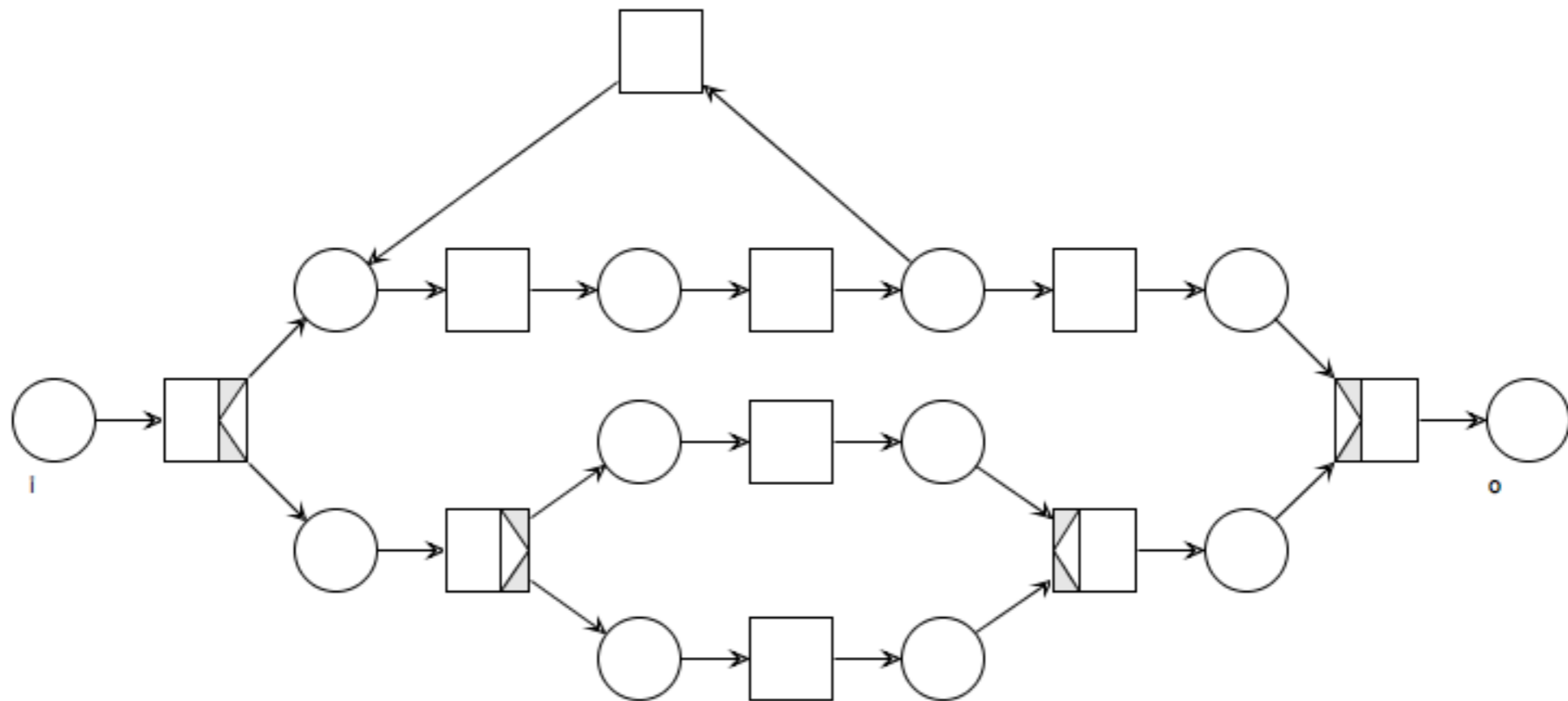

Example: abstraction

Prove that the net below is
a safe and sound workflow net

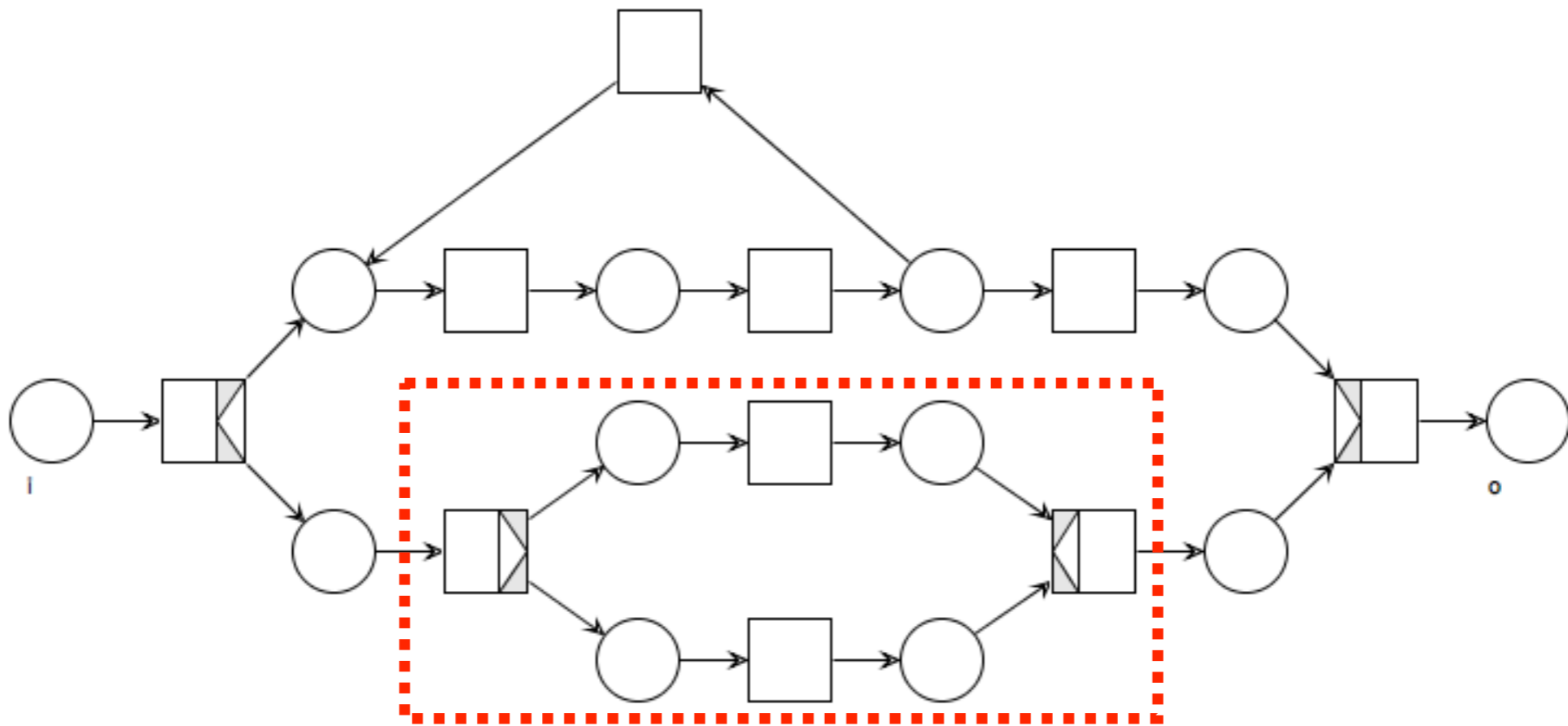

Example: abstraction

Prove that the net below is
a safe and sound workflow net

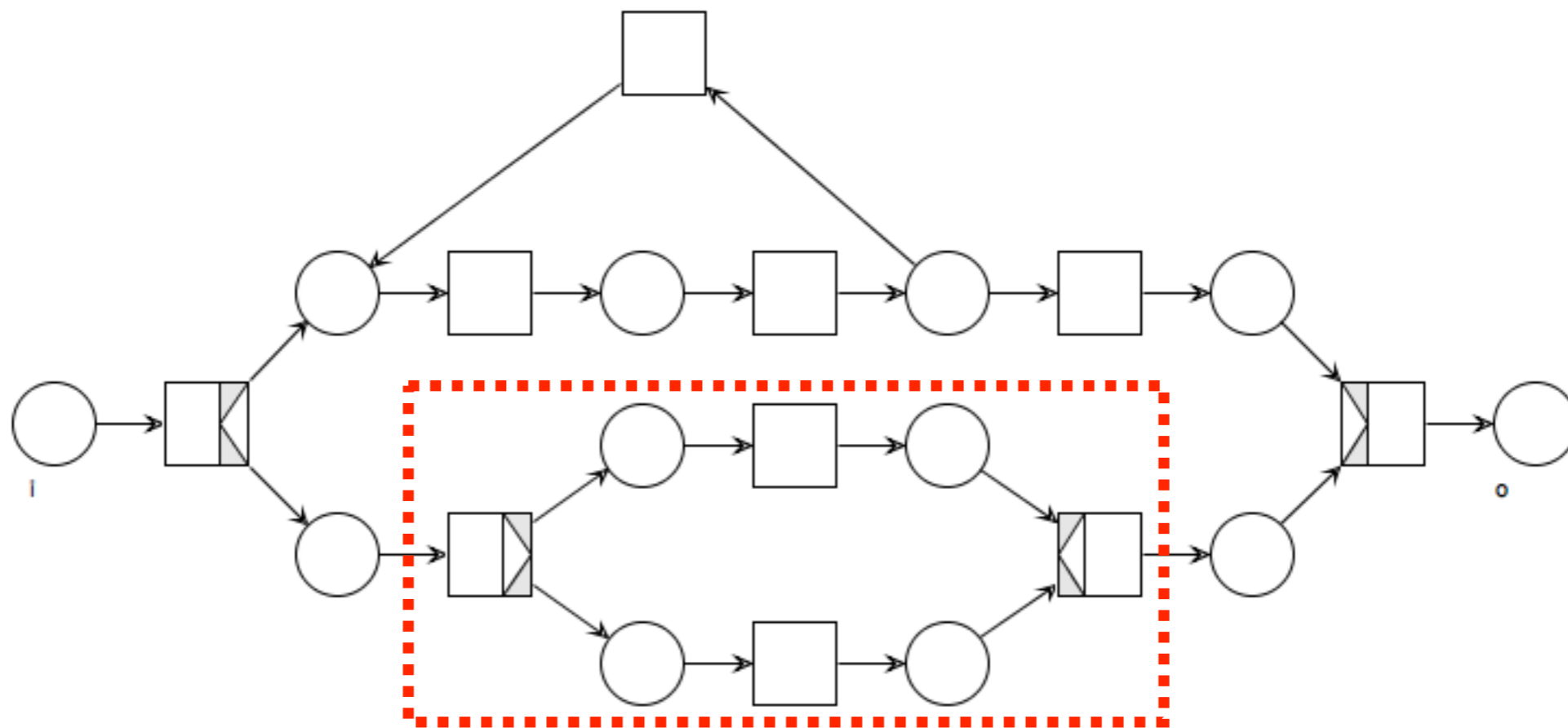

explicit XOR block

Example: abstraction

Prove that the net below is
a safe and sound workflow net

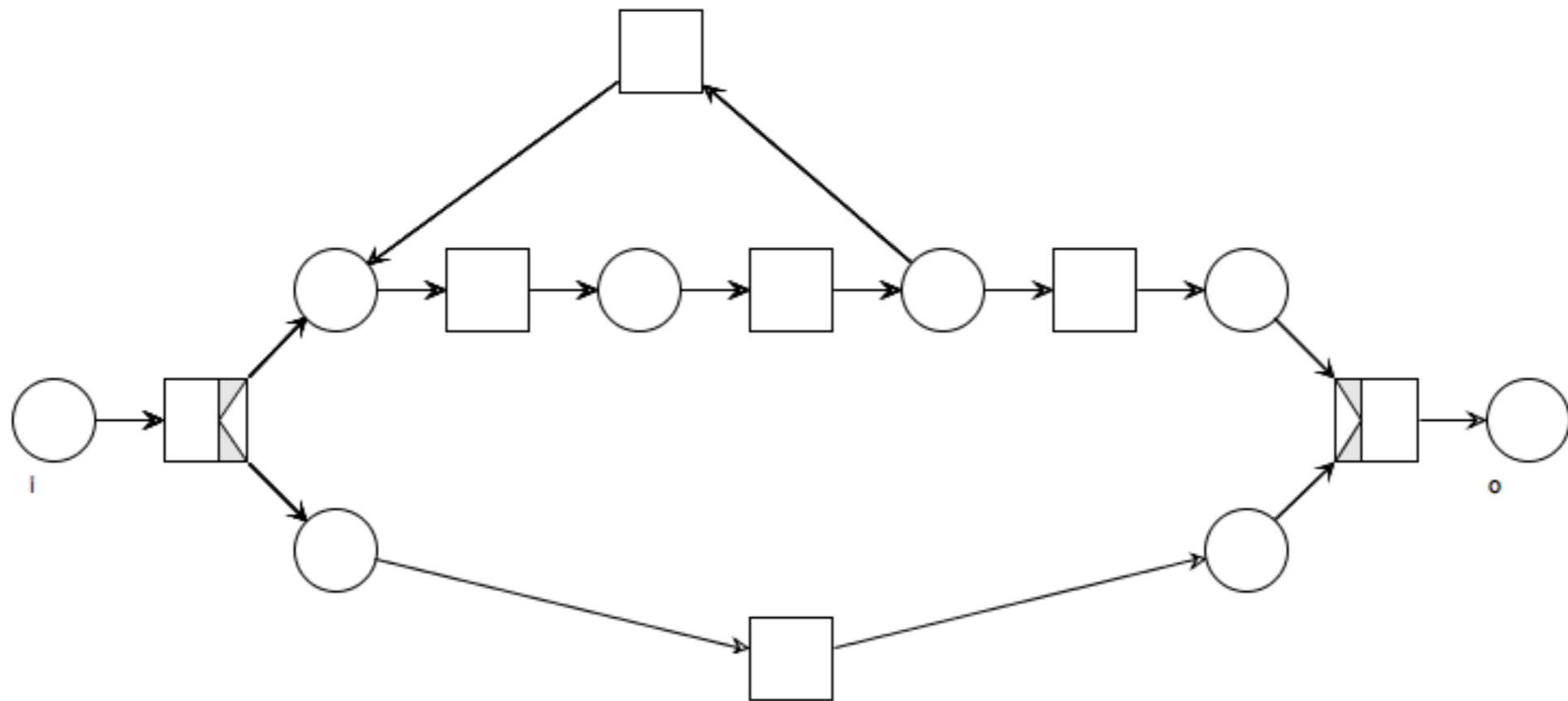

Example: abstraction

Prove that the net below is
a safe and sound workflow net

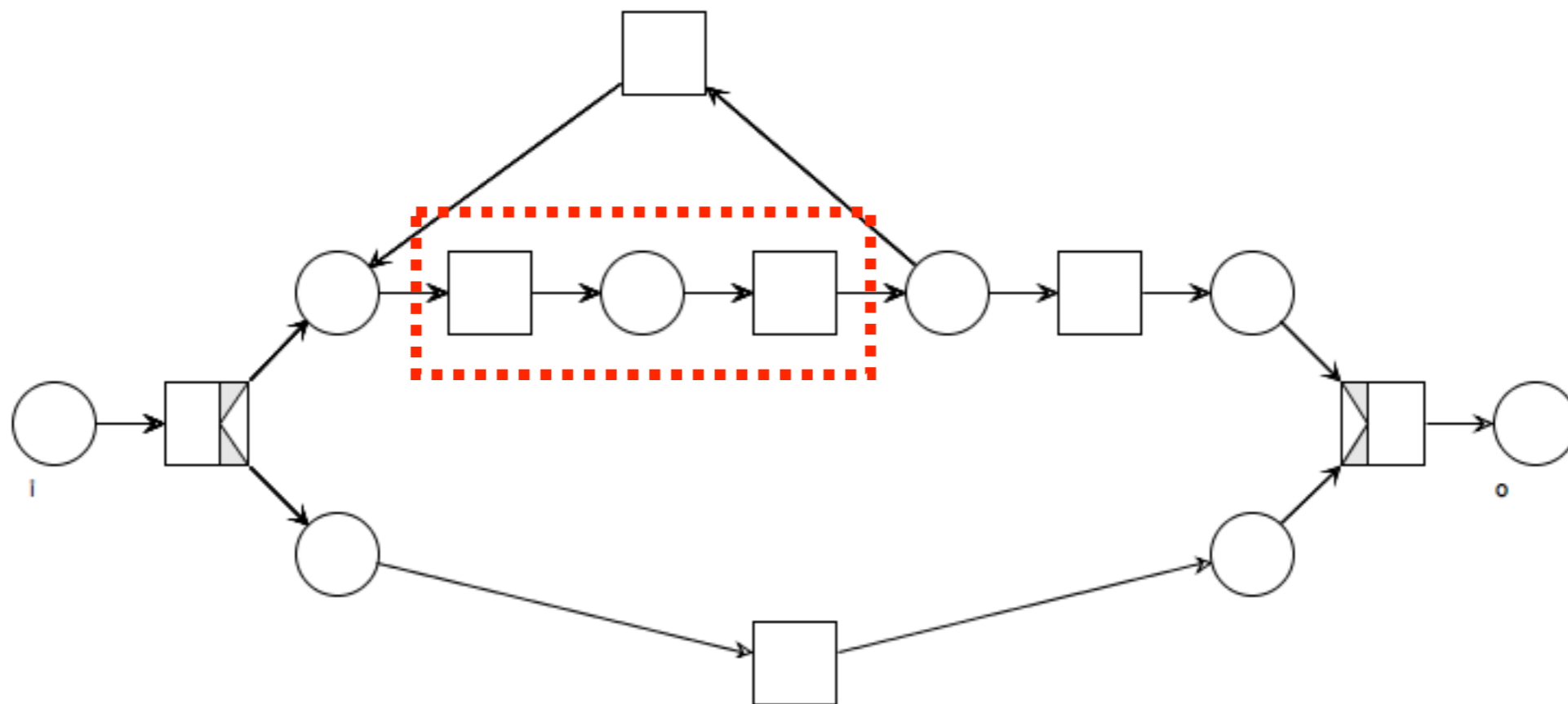

Example: abstraction

Prove that the net below is
a safe and sound workflow net

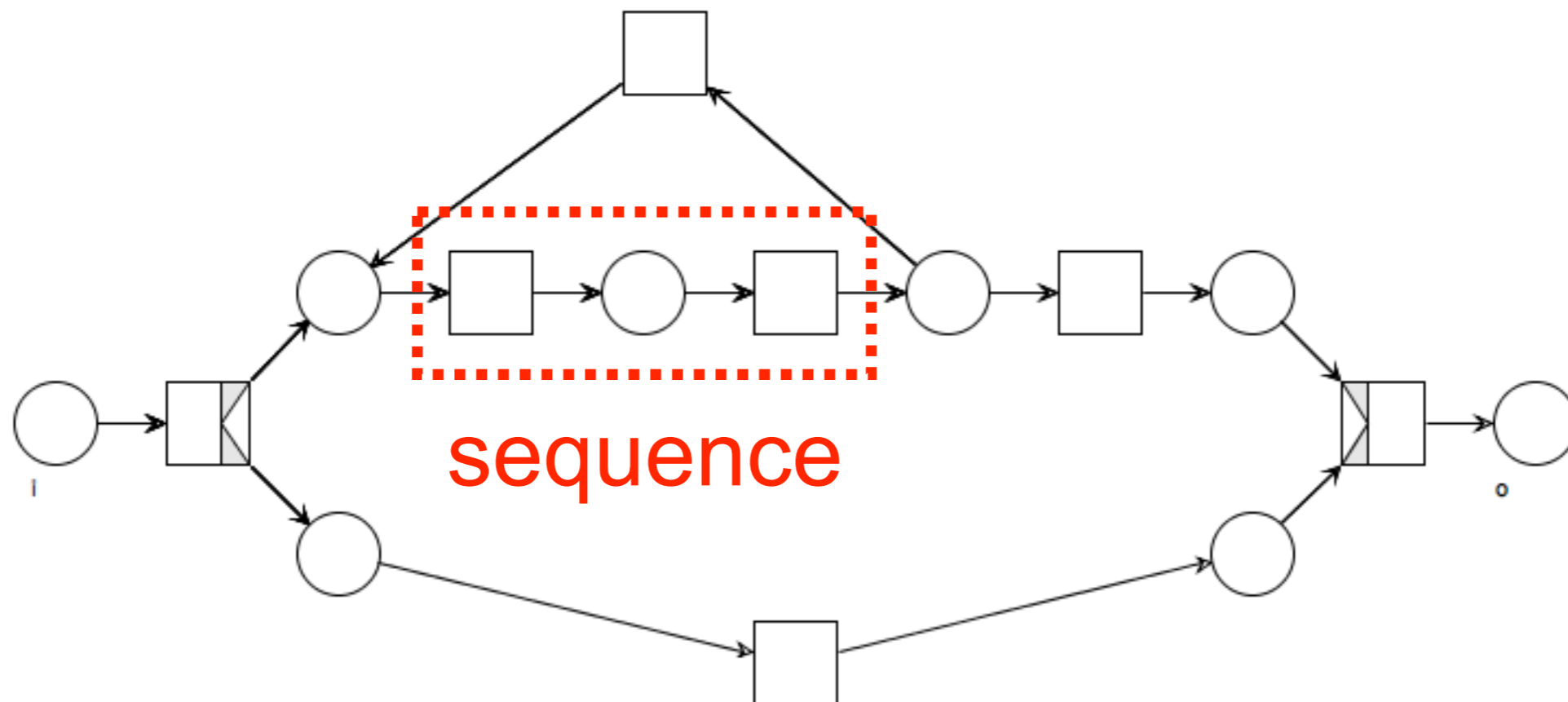

Example: abstraction

Prove that the net below is
a safe and sound workflow net

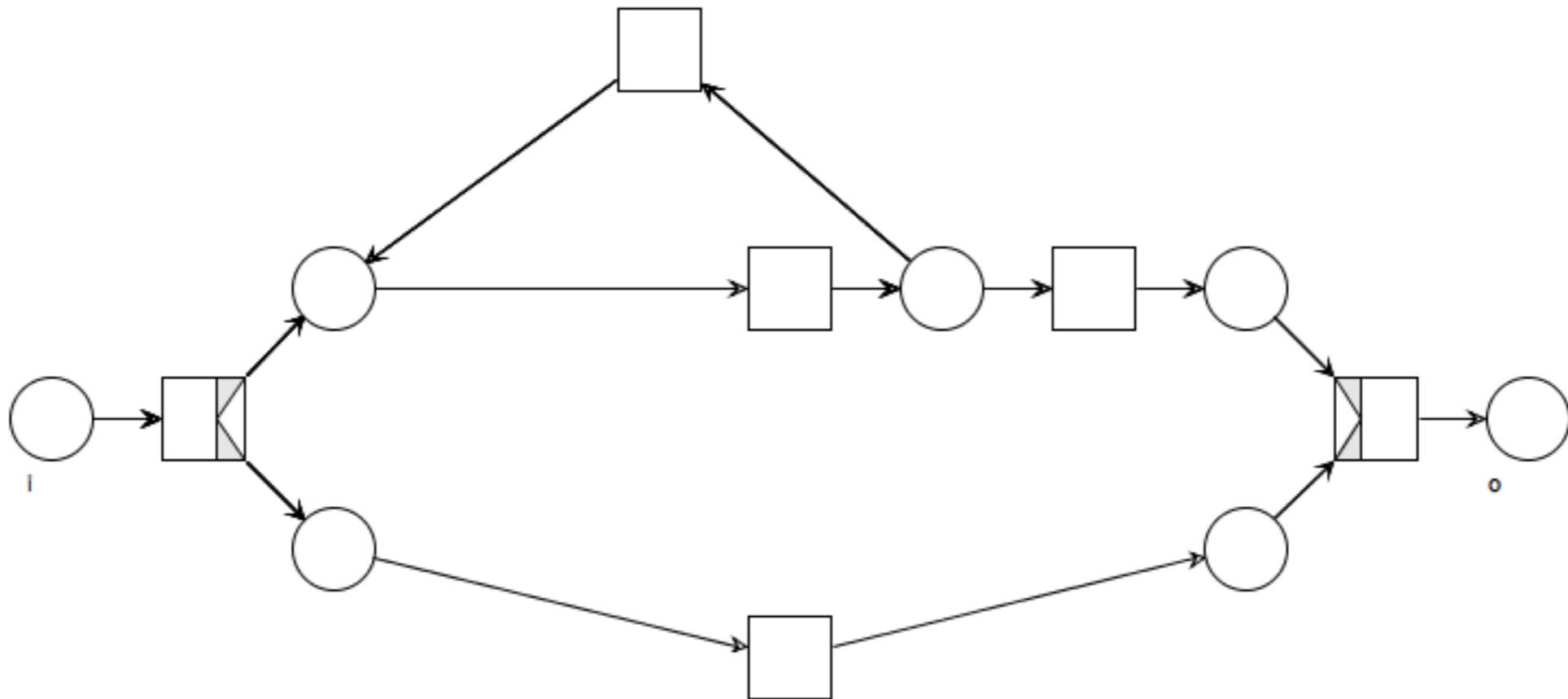

Example: abstraction

Prove that the net below is
a safe and sound workflow net

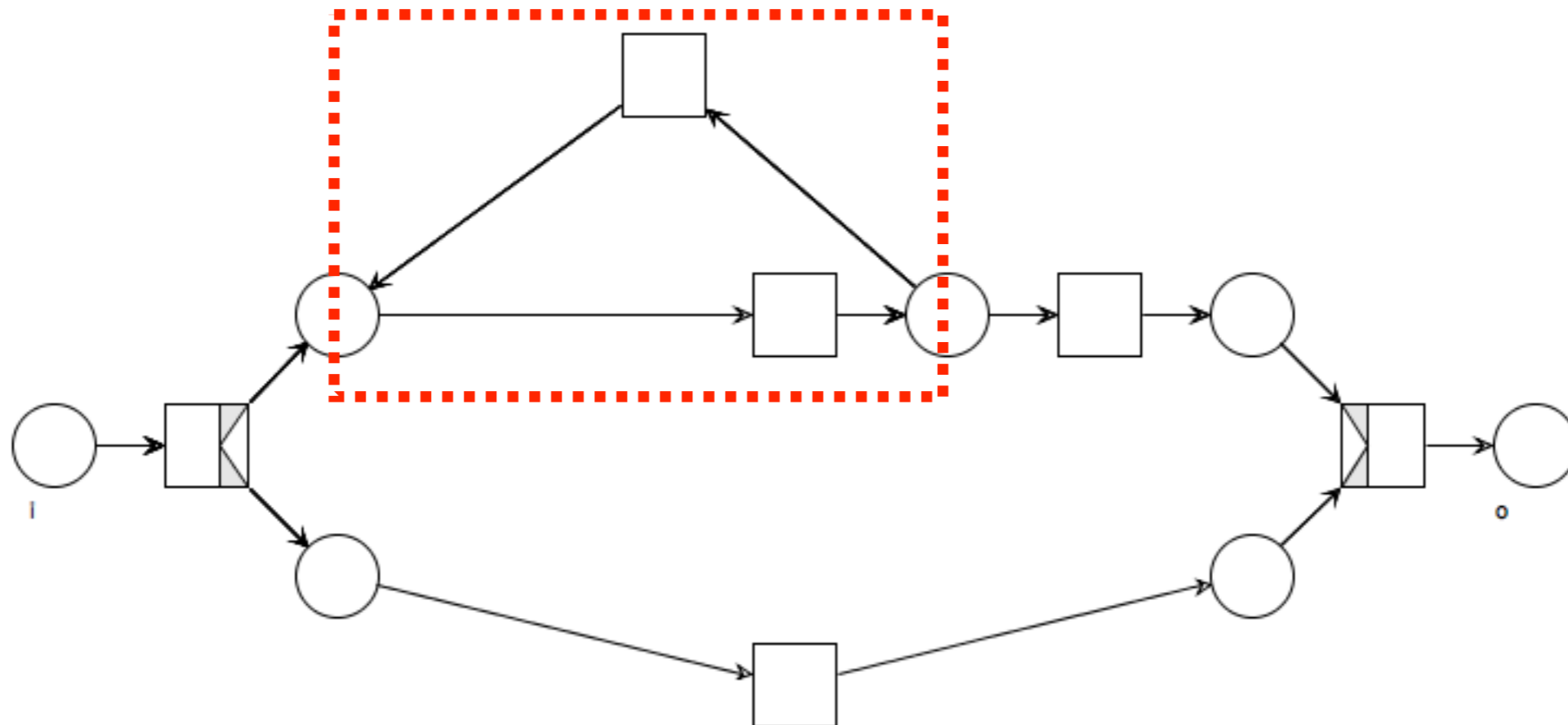

Example: abstraction

Prove that the net below is a safe and sound workflow net

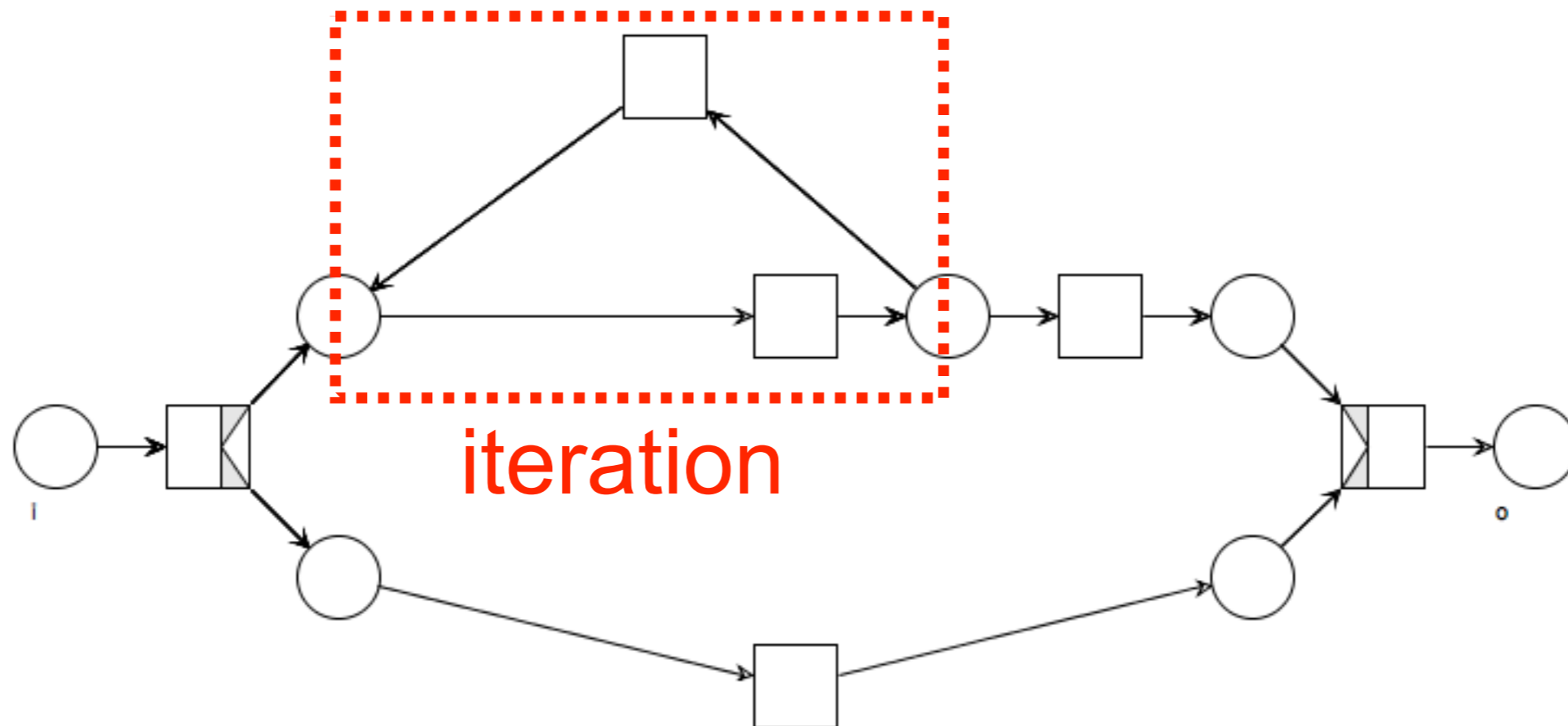

Example: abstraction

Prove that the net below is
a safe and sound workflow net

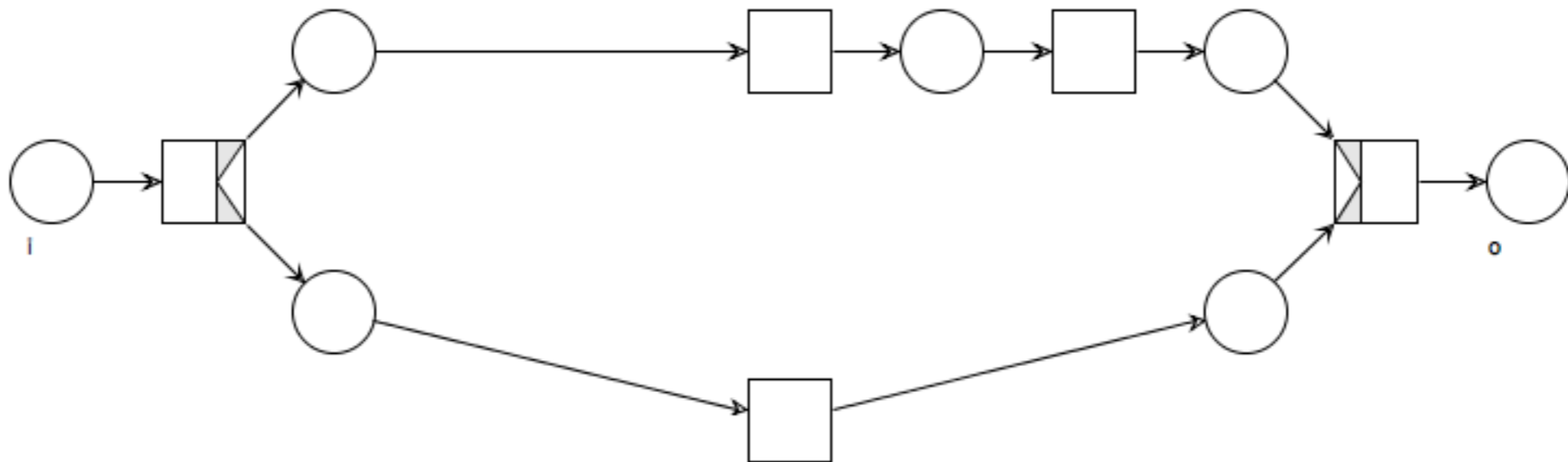

Example: abstraction

Prove that the net below is
a safe and sound workflow net

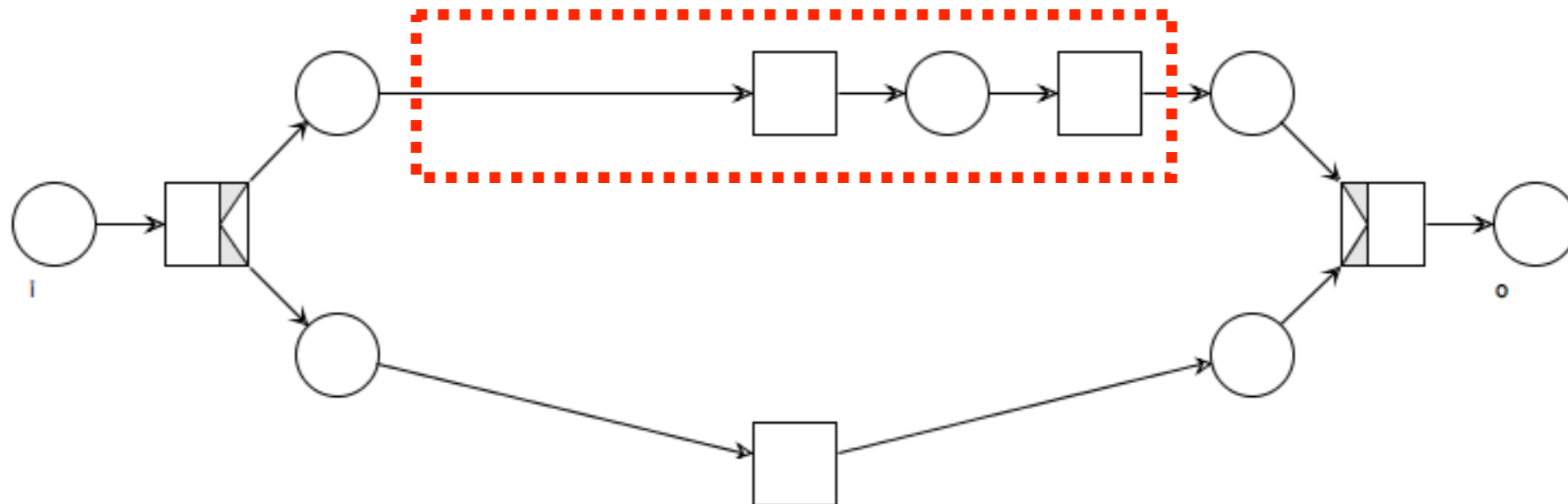

Example: abstraction

Prove that the net below is
a safe and sound workflow net

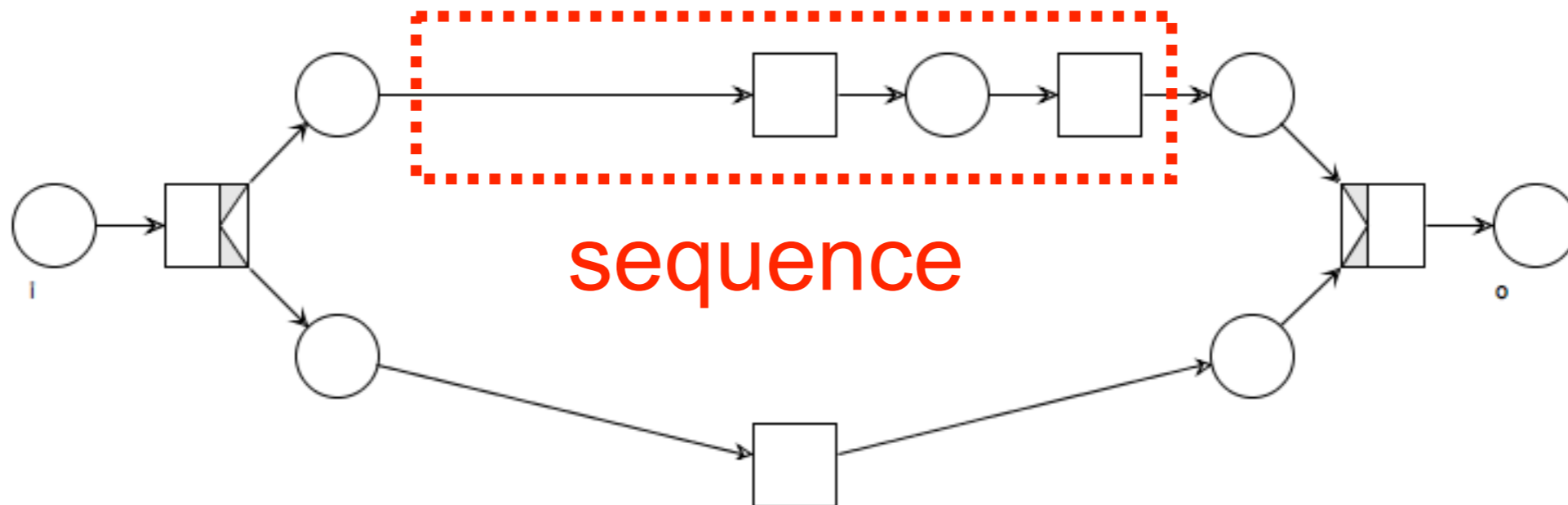

Example: abstraction

Prove that the net below is
a safe and sound workflow net

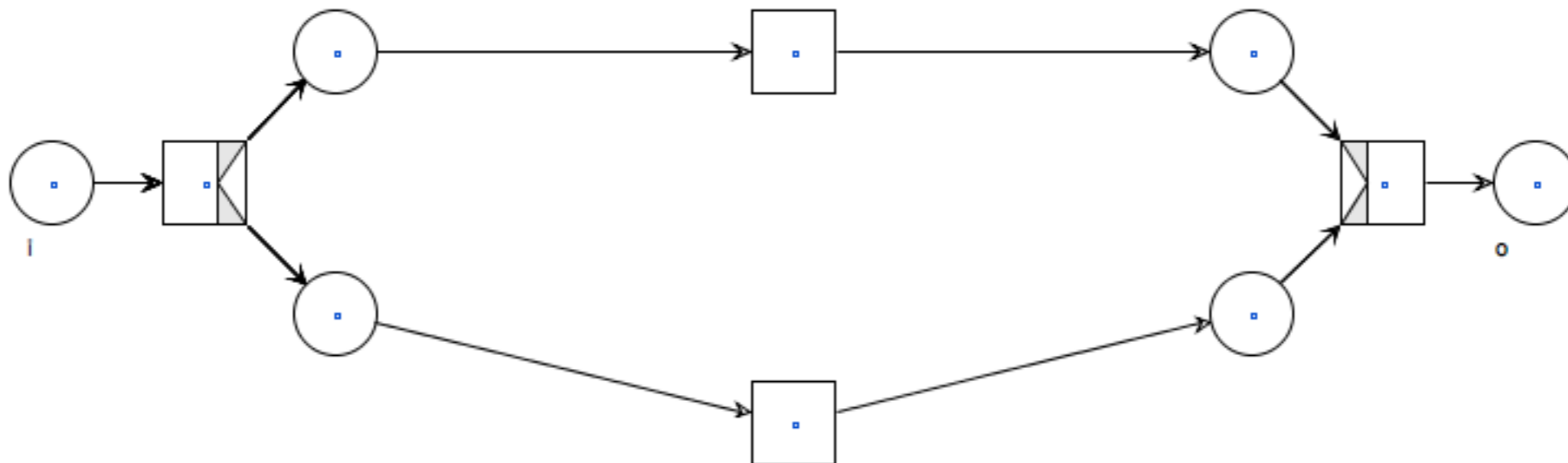

Example: abstraction

Prove that the net below is
a safe and sound workflow net

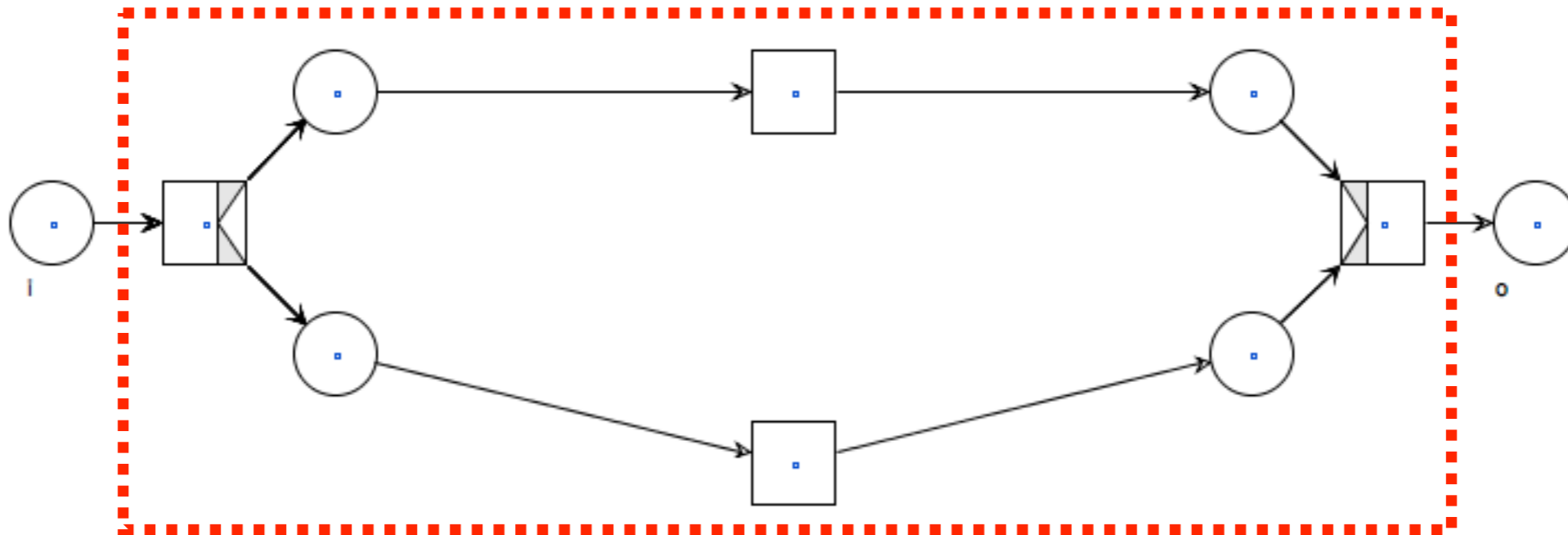

Example: abstraction

Prove that the net below is
a safe and sound workflow net

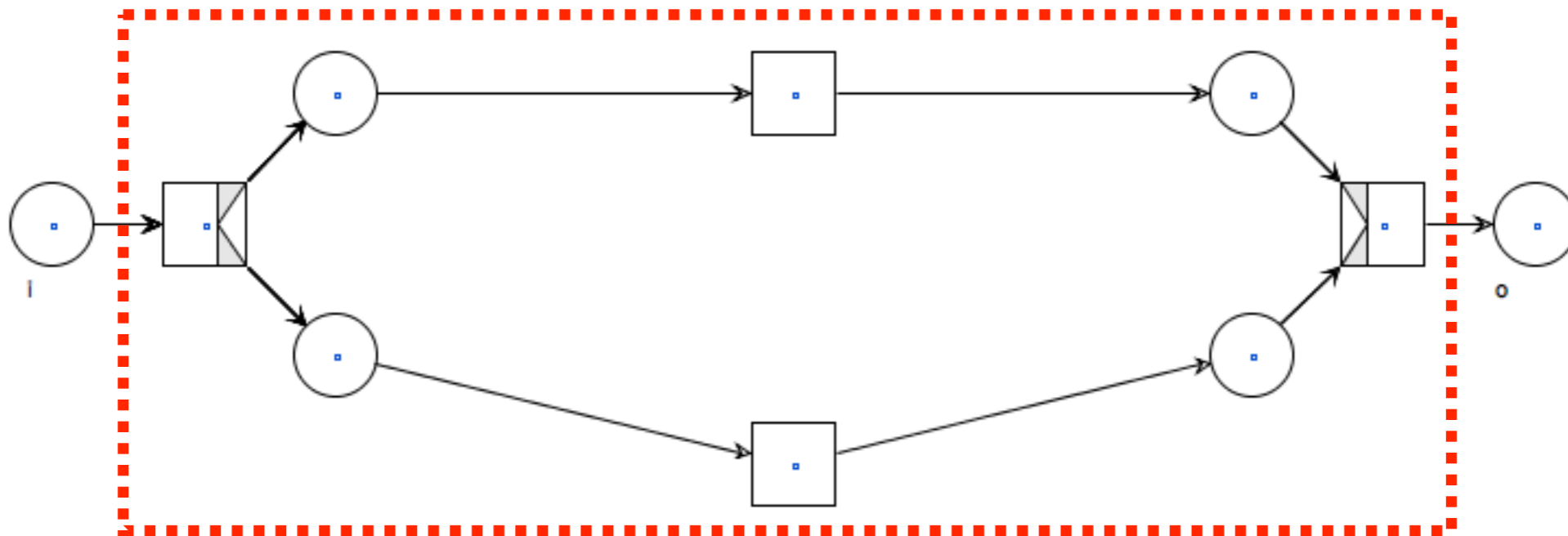

parallel (AND) block

Example: abstraction

Prove that the net below is
a safe and sound workflow net

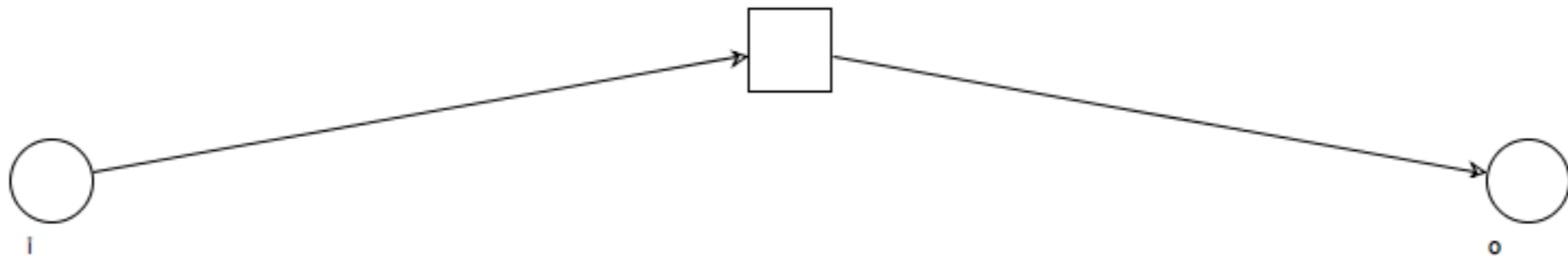

Exercise

Prove that the net below is a safe and sound workflow net

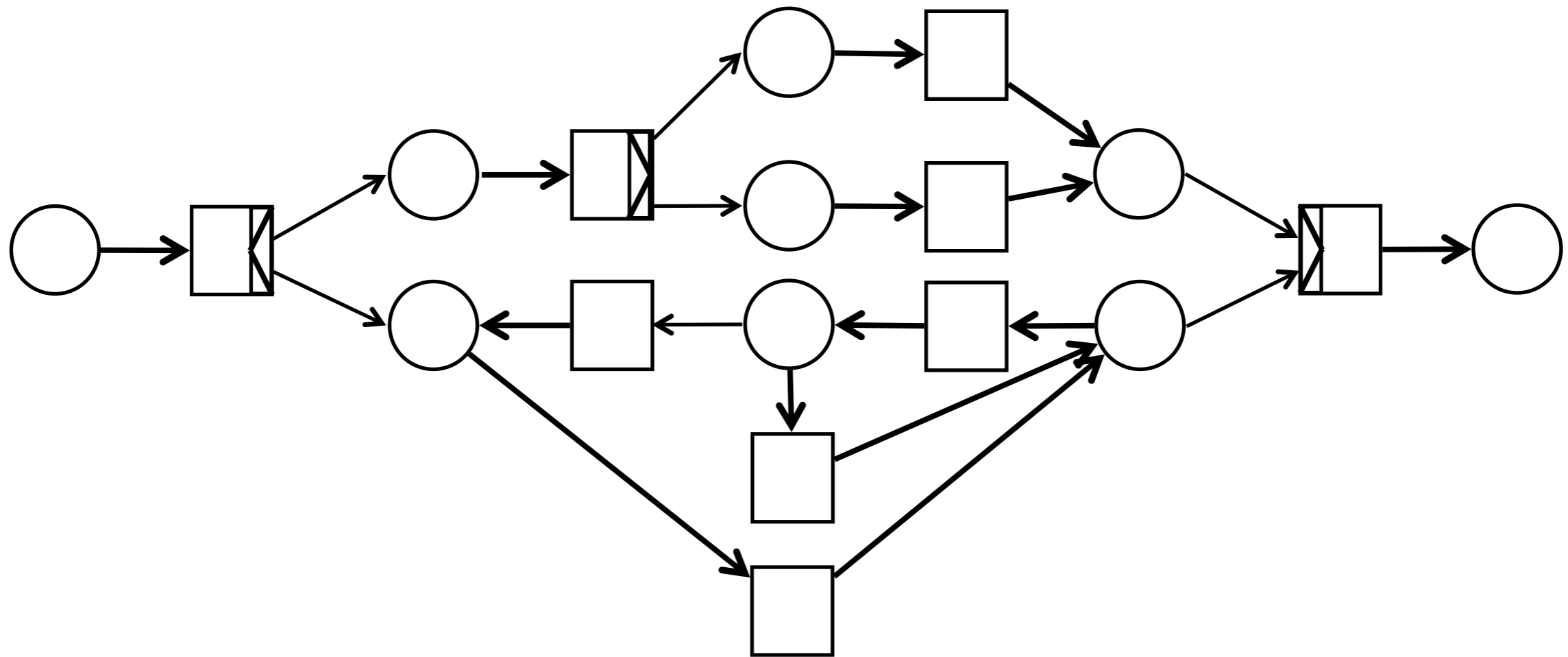

Exercise

Prove that the net below is a safe and sound workflow net (hint: "desugar" it)

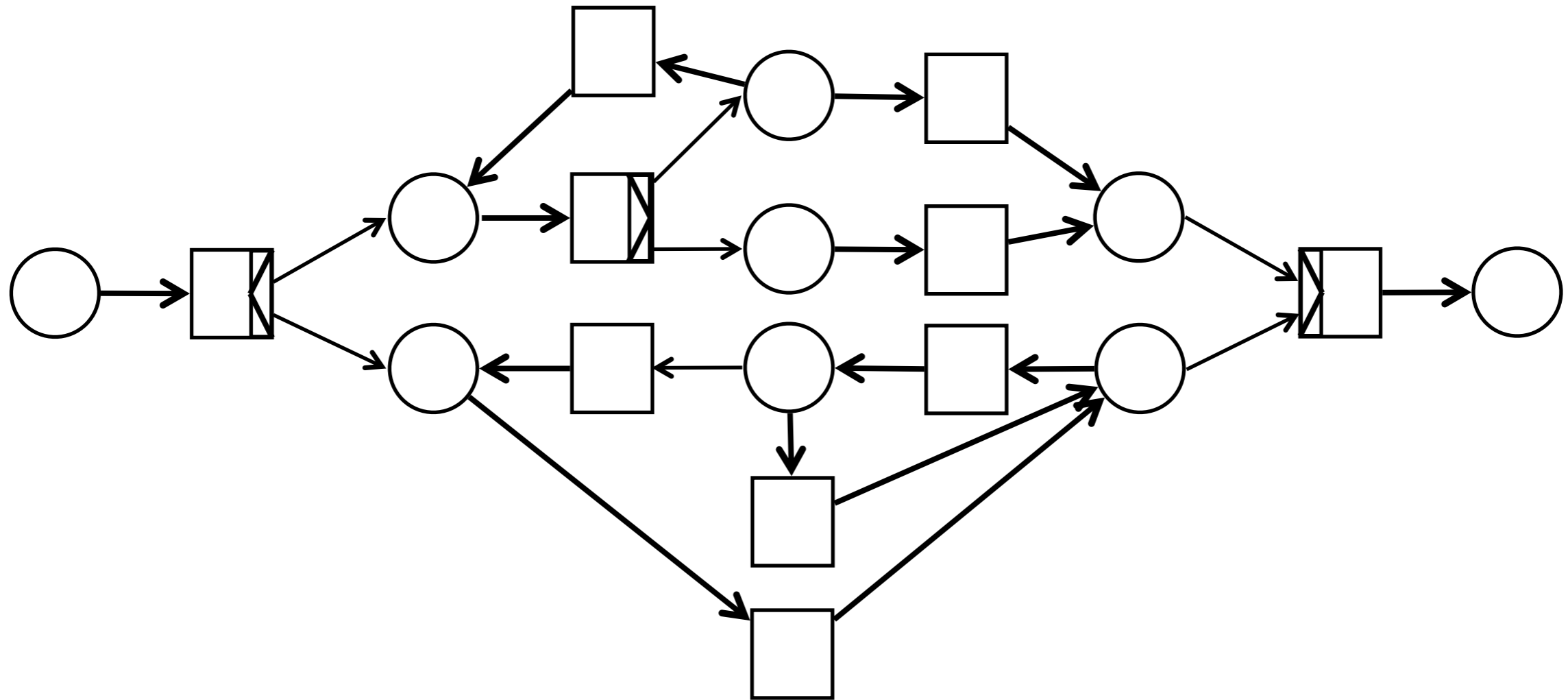

Generalization

We would like to progressively refine transitions with multiple incoming and outgoing arcs

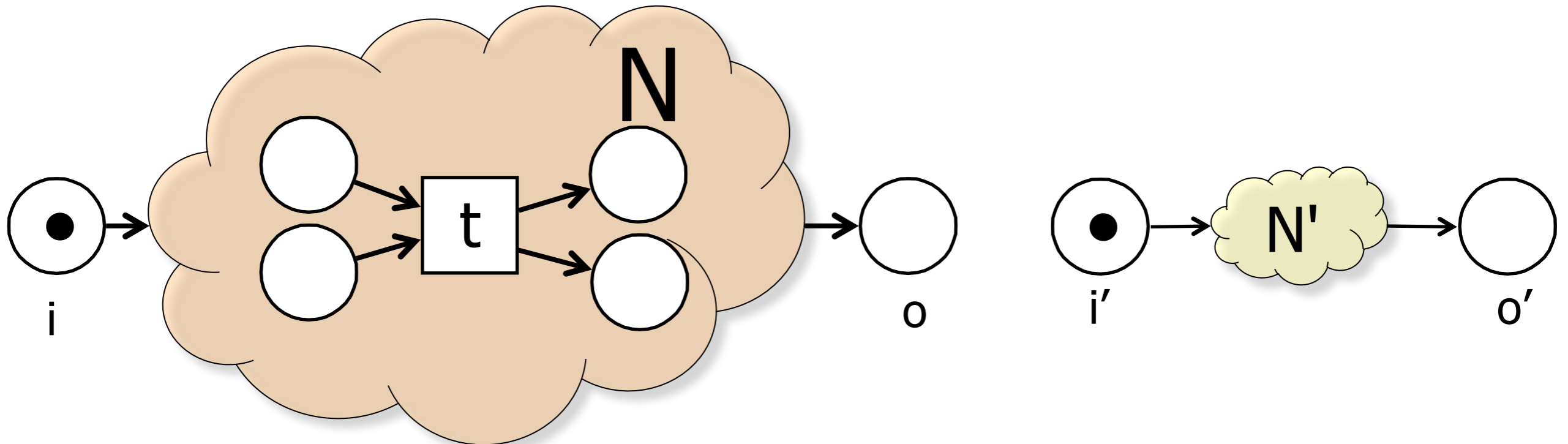

Two facts

Lemma: Let N be a sound WF net.
If $(i,t) \in F$ then the pre-set of t is $\{i\}$

(otherwise t would be a dead transition)

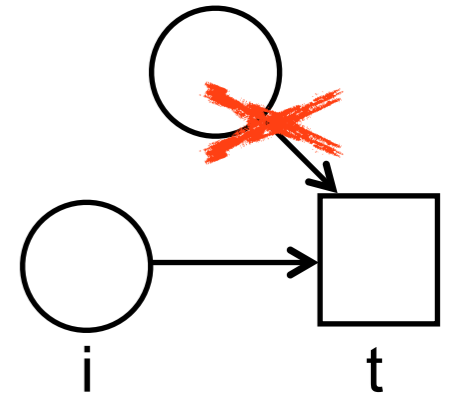

Lemma: Let N be a sound WF net.
If $(t,o) \in F$ then the post-set of t is $\{o\}$

(otherwise t would be dead or proper completion would not hold)

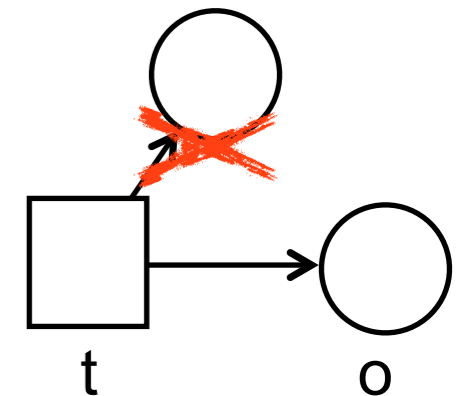

General replacement

Let $T_{i'} = \{ u \mid \bullet u = \{i'\} \}$.

Let $T_{o'} = \{ v \mid v\bullet = \{o'\} \}$.

If $(p, t) \in F_N, u \in T_{i'}$ then $(p, u) \in F_{N[N'/t]}$

If $(t, q) \in F_N, v \in T_{o'}$ then $(v, q) \in F_{N[N'/t]}$

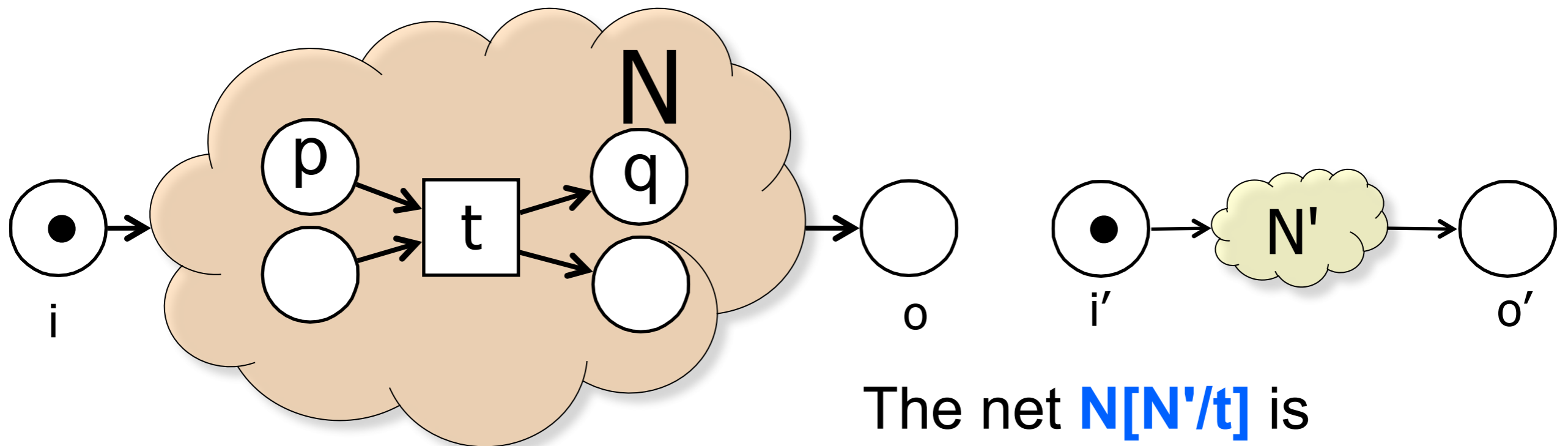

The net $N[N'/t]$ is
a **sound and safe workflow net**

General replacement

Let $T_{i'} = \{ u \mid \bullet u = \{i'\} \}$. (initial transitions of N')

Let $T_{o'} = \{ v \mid v\bullet = \{o'\} \}$. (final transitions of N')

If $(p, t) \in F_N, u \in T_{i'}$ then $(p, u) \in F_{N[N'/t]}$

If $(t, q) \in F_N, v \in T_{o'}$ then $(v, q) \in F_{N[N'/t]}$

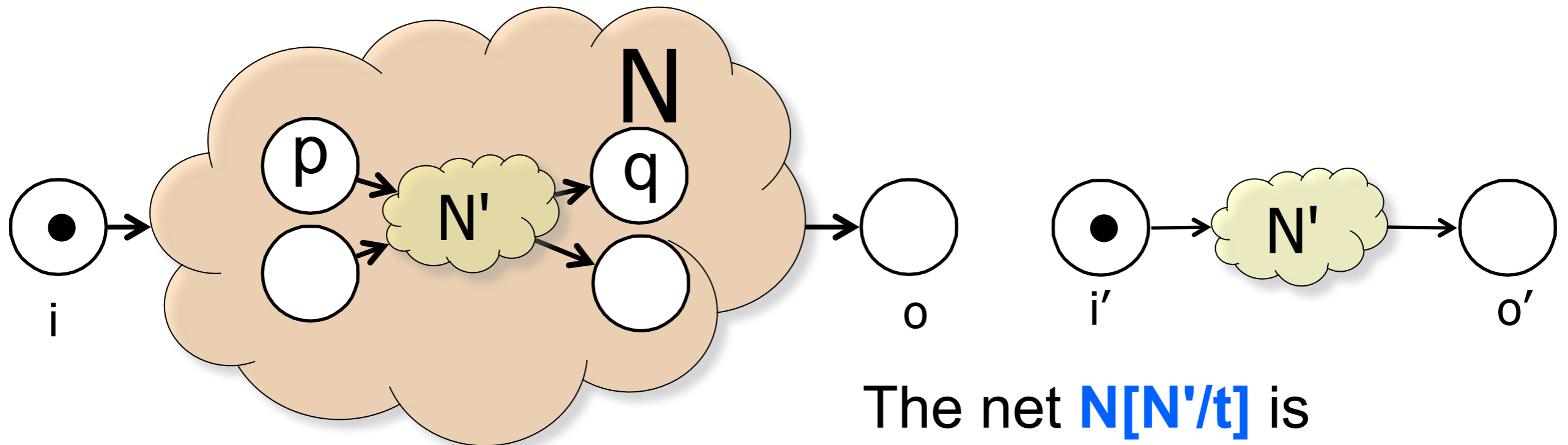

The net $N[N'/t]$ is
a **sound and safe workflow net**

Some Building Blocks 4

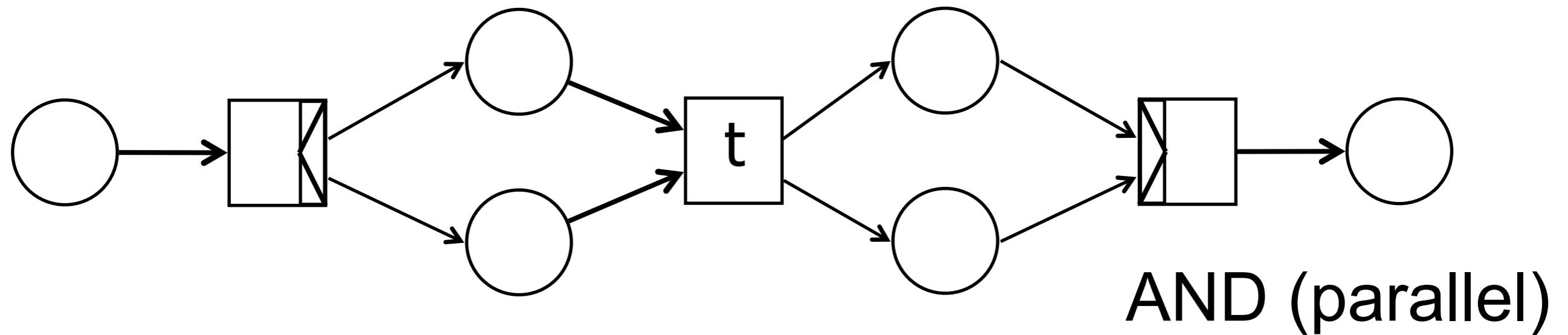

But you can define more blocks on your own

Exercise

Prove that the net below is
a safe and sound workflow net

