

Methods for the specification and verification of business processes

MPB (6 cfu, 295AA)

Roberto Bruni

<http://www.di.unipi.it/~bruni>

20 - Event-driven
process chains

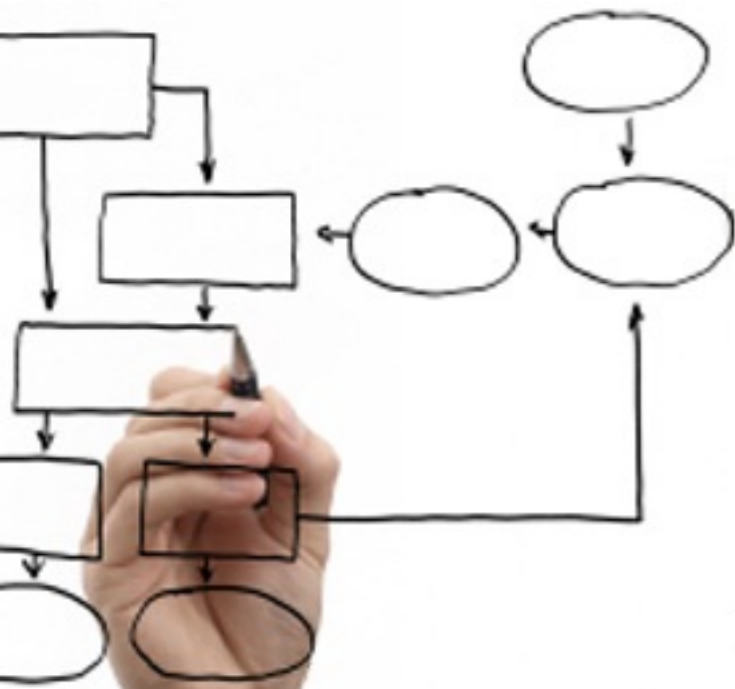

Object

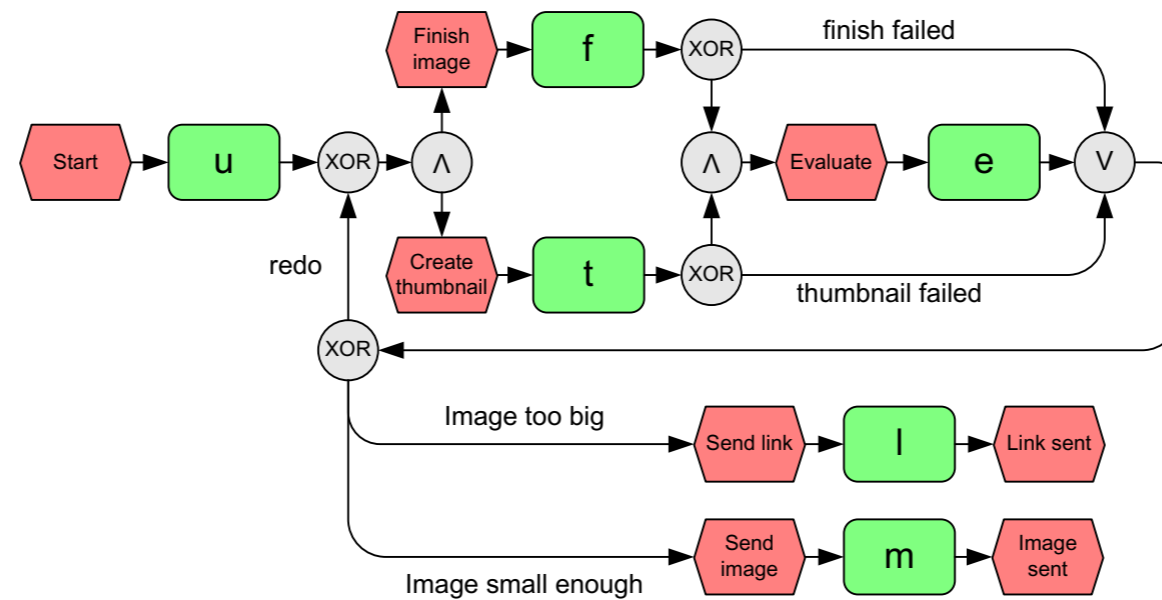

We overview EPC and the main challenges that arise when analysing them with Petri nets

Event-driven Process Chain

An **Event-driven Process Chain (EPC)** is a particular type of flow-chart that can be used for configuring an Enterprise Resource Planning (ERP) implementation

Supported by many tools (e.g. SAP R/3)

EPC Markup Language available (EPML)
as interchange format

EPC overview

Important notation to model the domain aspects
of business processes

Rather informal notation

EPC focus is on representing domain concepts
and processes (not their formal aspects and
technical realization)

It can be used to drive the modelling, analysis
and redesign of business process

EPC origin

EPC method was originally developed by Wilhelm-August Scheer (early 1990's)



Part of a holistic modelling approach called
ARIS framework
(Architecture of Integrated Information Systems)

ARIS house (1999):
three pillars and a roof...

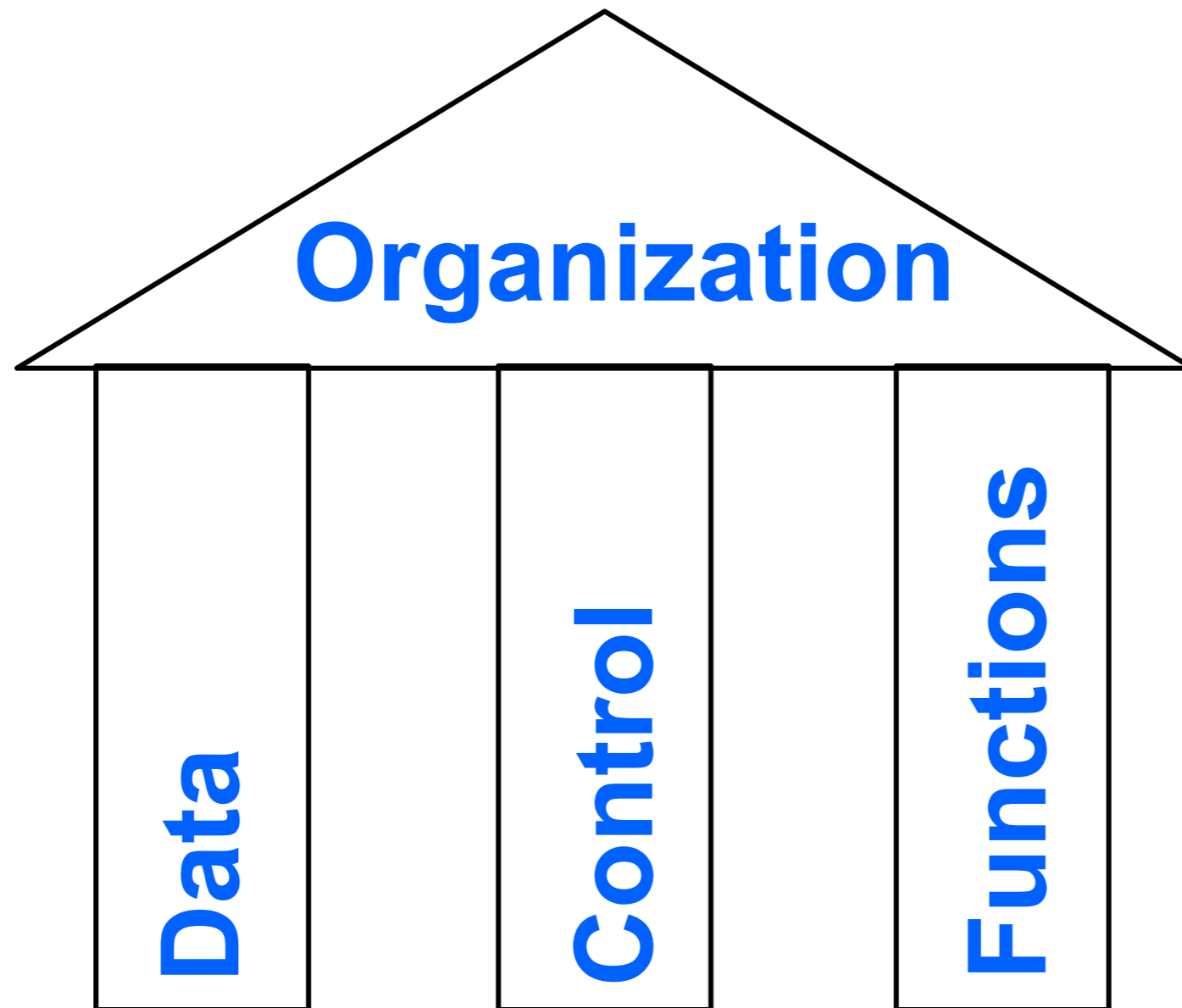

...and three levels of abstraction each

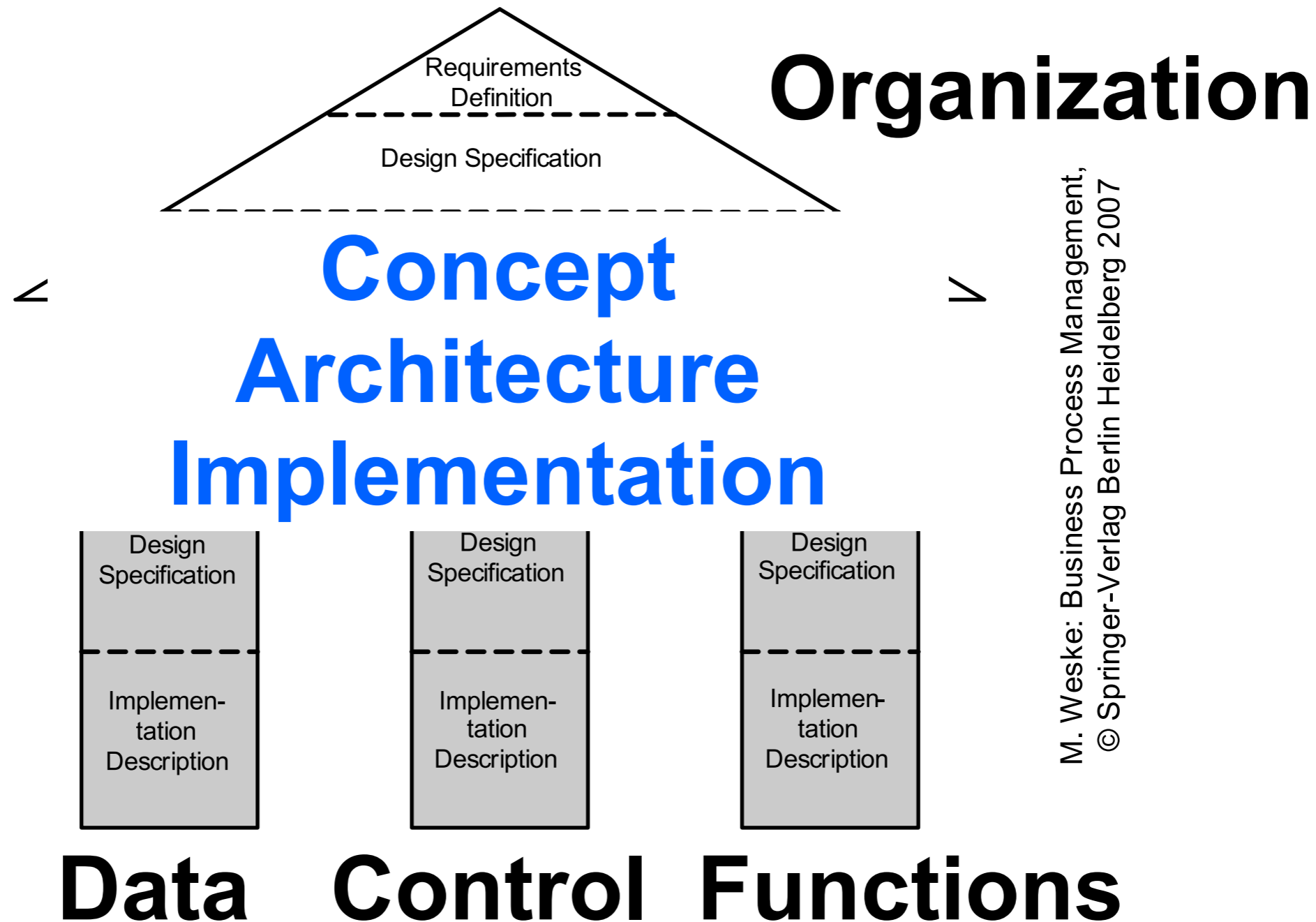

M. Weske: Business Process Management,
© Springer-Verlag Berlin Heidelberg 2007

...and three levels of abstraction each

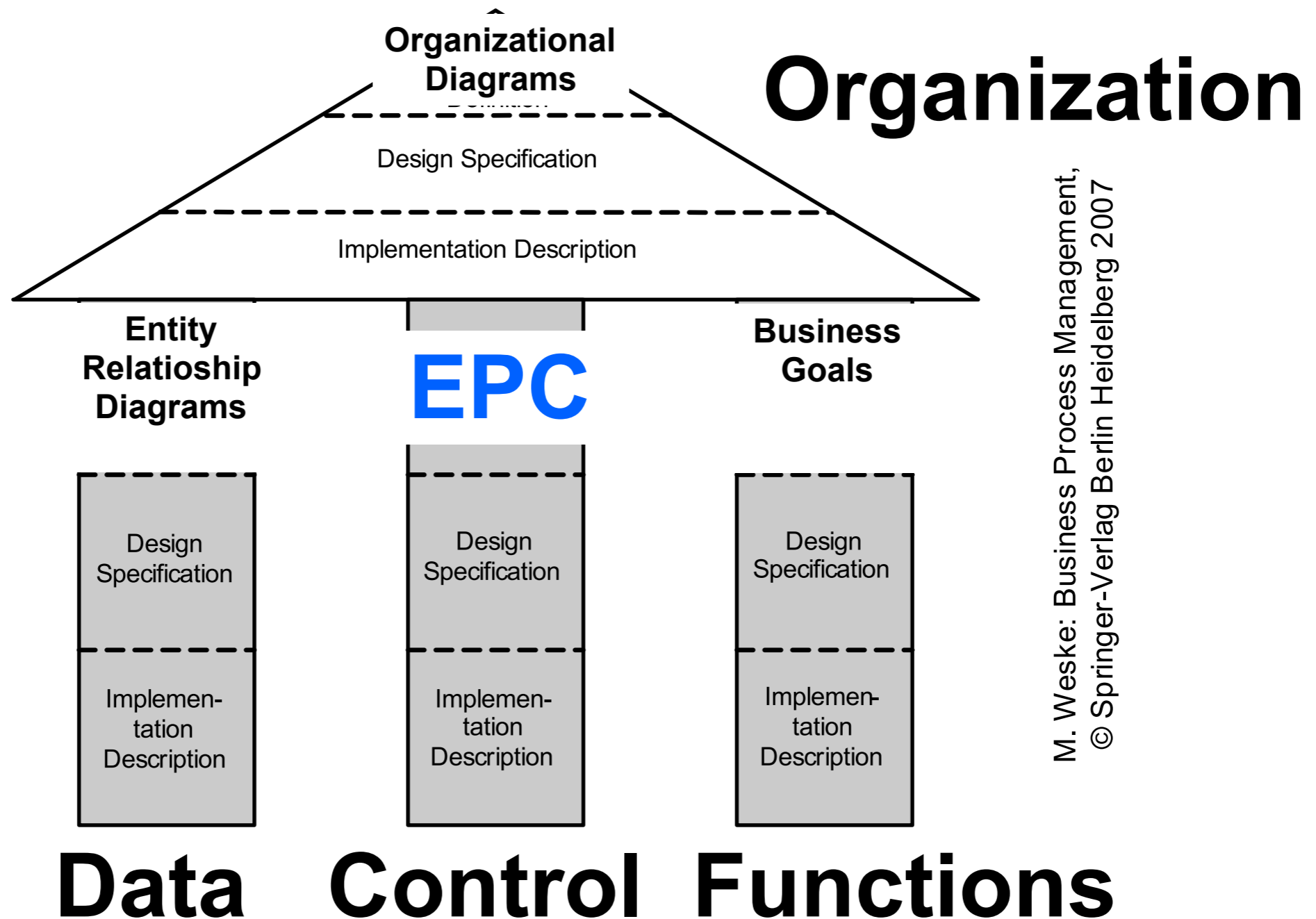

M. Weske: Business Process Management,
© Springer-Verlag Berlin Heidelberg 2007

EPC informally

An EPC is an “ordered” graph
of events and functions

It provides various connectors that allow
alternative and parallel execution of processes

The flow is specified by logical operators
AND, XOR, OR

Simple, easy-to-understand notation

EPC ingredients: Event

Any EPC diagram must
start with **event(s)**
and end with **event(s)**

Passive elements used to describe
under which circumstances a process (or a function) works
or which state a process (or a function) results in
(like pre- / post-conditions)

Graphical representation: hexagons

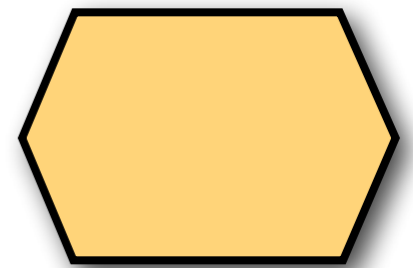

EPC ingredients: Function

Any EPC diagram may involve
several **functions**

Active elements used to describe
the tasks or activities of a business process

Functions can be refined to other EPC

Graphical representation:
rounded rectangles



EPC ingredients: Logical connectors

Any EPC diagram may involve
several **connectors**

Elements used to describe
the logical relationships between elements in the diagram

Branch, merge, fork, join

Graphical representation:
circles (or also octagons)

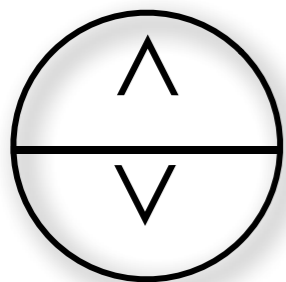

AND OR

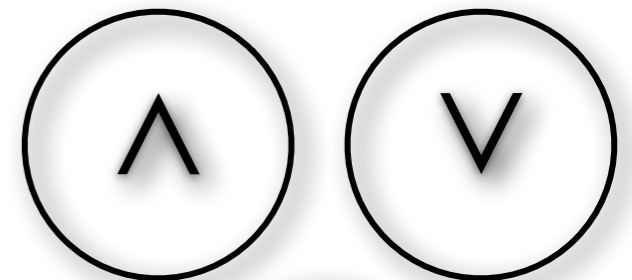

XOR

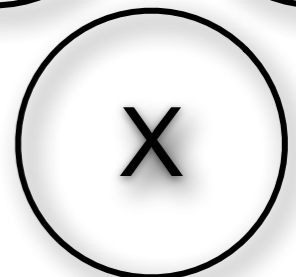

EPC ingredients: Control flow

Any EPC diagram may involve several **control flow connections**

Control flow is used to connect events with functions and connectors by expressing causal dependencies

Graphical representation:
dashed arrows



EPC ingredients at a glance

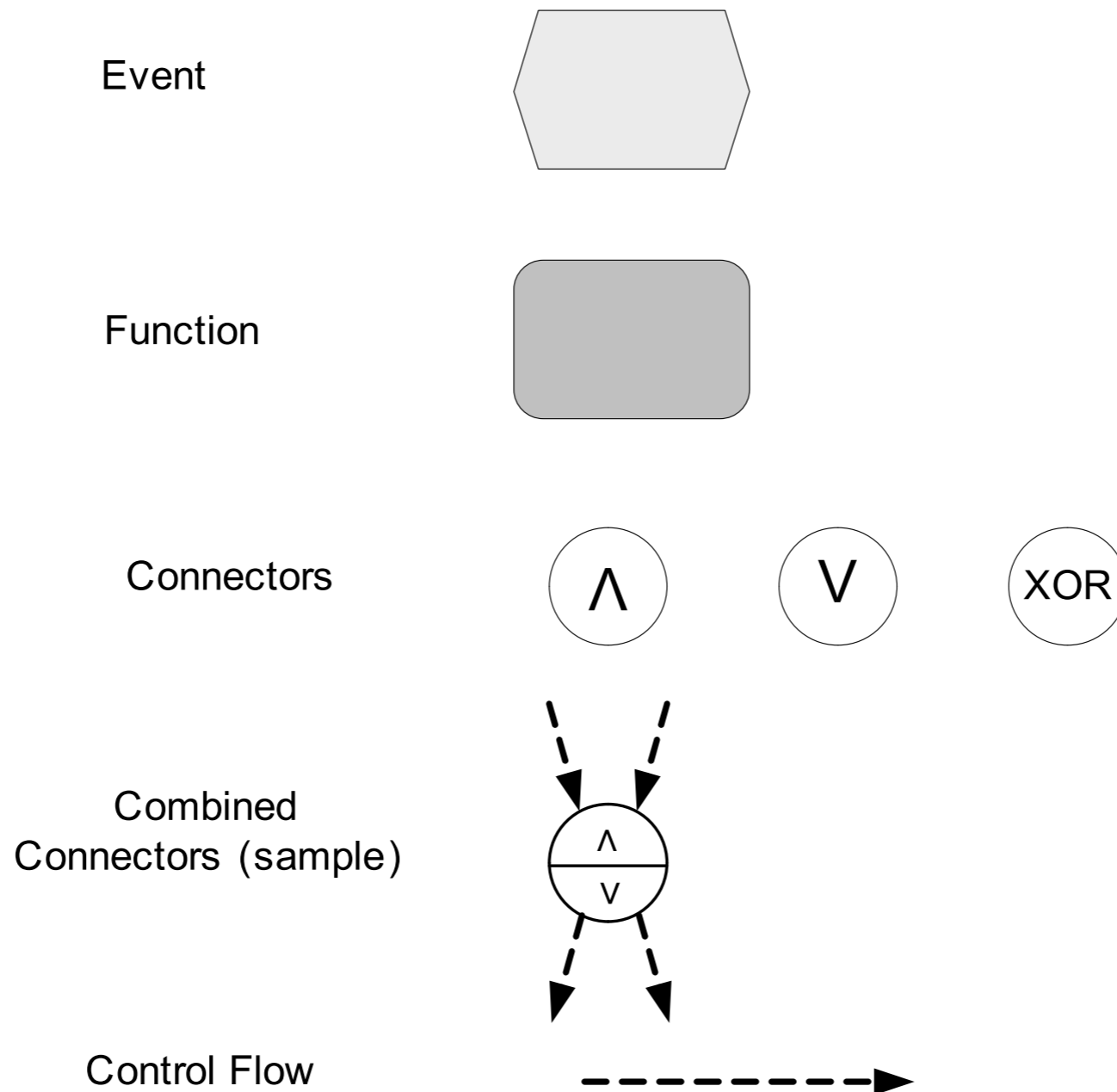

M. Weske: Business Process Management,
© Springer-Verlag Berlin Heidelberg 2007

EPC ingredients: Diagrams

EPC elements can be combined in a fairly free manner
(possibly including cycles)

There must be at least one start event and one end event
Events have at most one incoming and one outgoing arc
Events have at least one incident arc

Functions have exactly one incoming and one outgoing arc

The graph is weakly connected (no isolated nodes)

Connectors have either one incoming arc and multiple outgoing arcs
or viceversa (multiple incoming arcs and one outgoing arc)

EPC ingredients: Diagrams

Other constraints are sometimes imposed

There is no arc between two events
There is no arc between two functions

Unique start / end event

No event is followed by a decision node
(i.e. (X)OR-split)

EPC allowed connections

	Event Connection		Activity Connection	
AND	<p>triggering Events</p>	<p>triggered Events</p>	<p>triggering Events</p>	<p>triggered Events</p>
OR			<p>not allowed</p>	
XOR			<p>not allowed</p>	

EPC an example

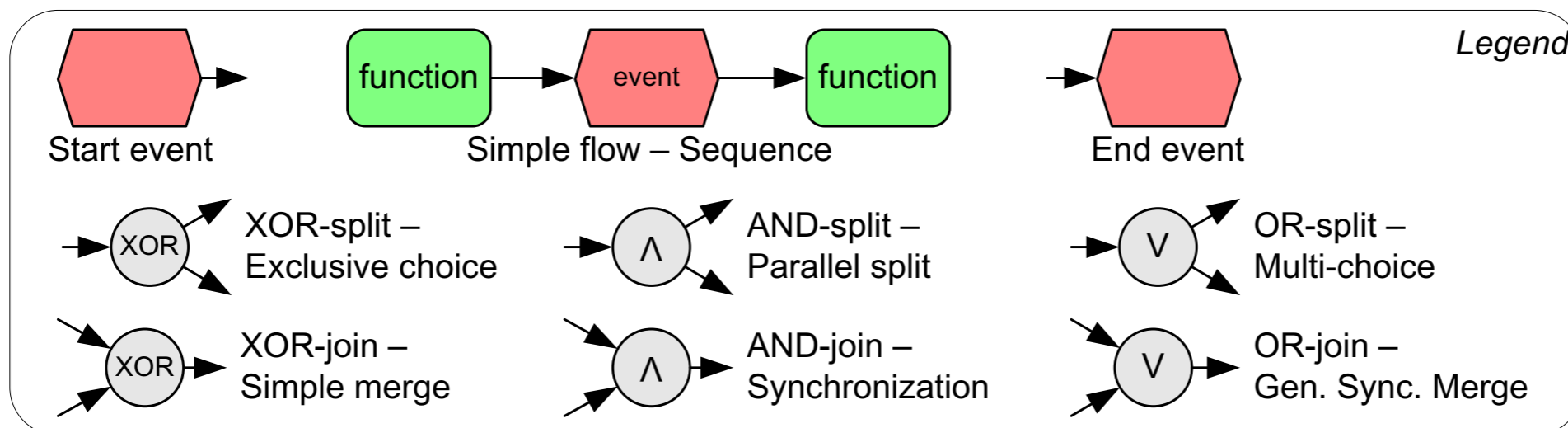
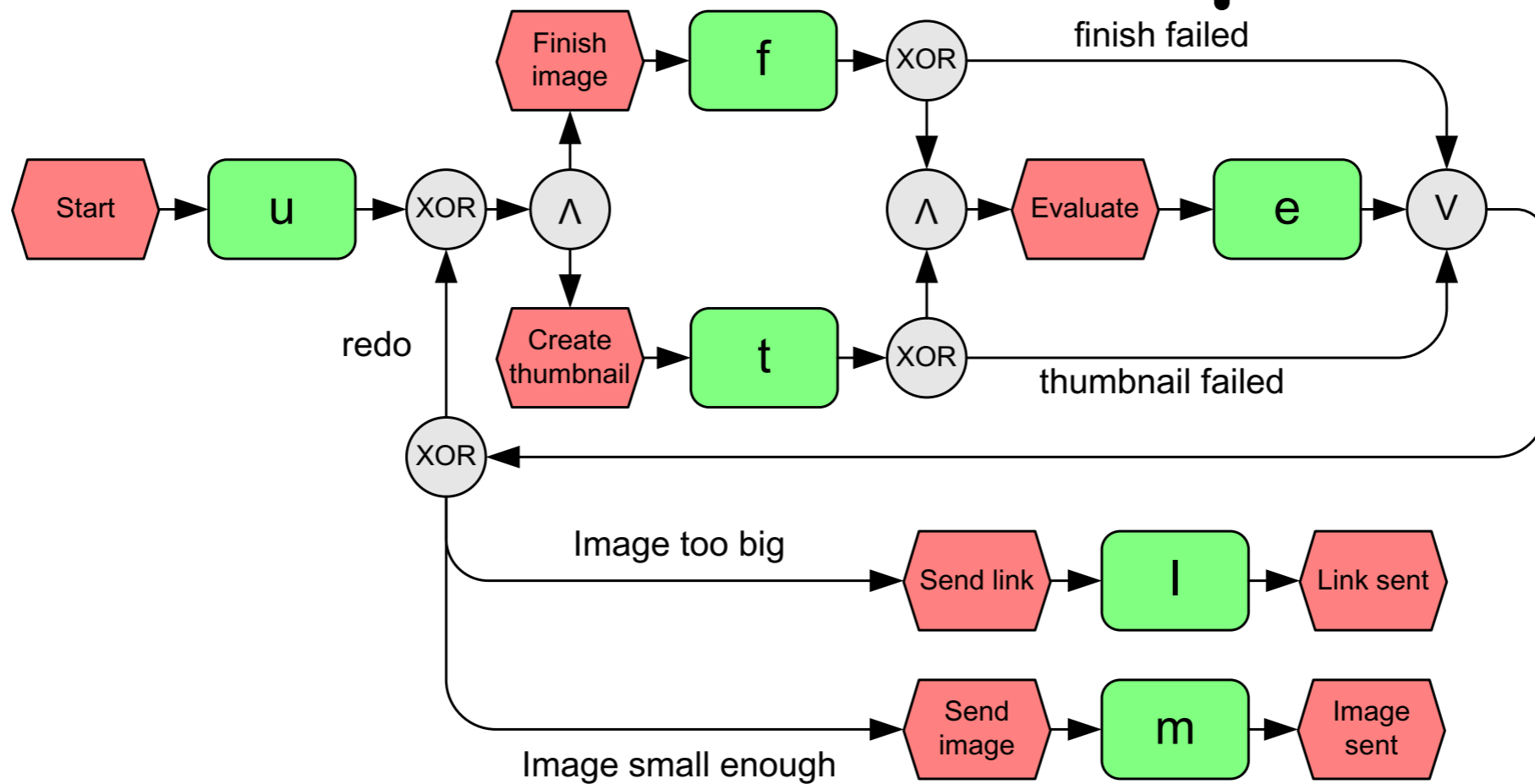

Other stuff

Other decorations / annotations for functions:

Information, material, resource object: represents objects in the real world that can be input data or output data for a function
(rectangles linked to function boxes)

Organization unit: determines the person or organization responsible for a specific function
(ellipses with a vertical line)

Supporting system: technical support
(rectangles with vertical lines on its sides)

Other stuff

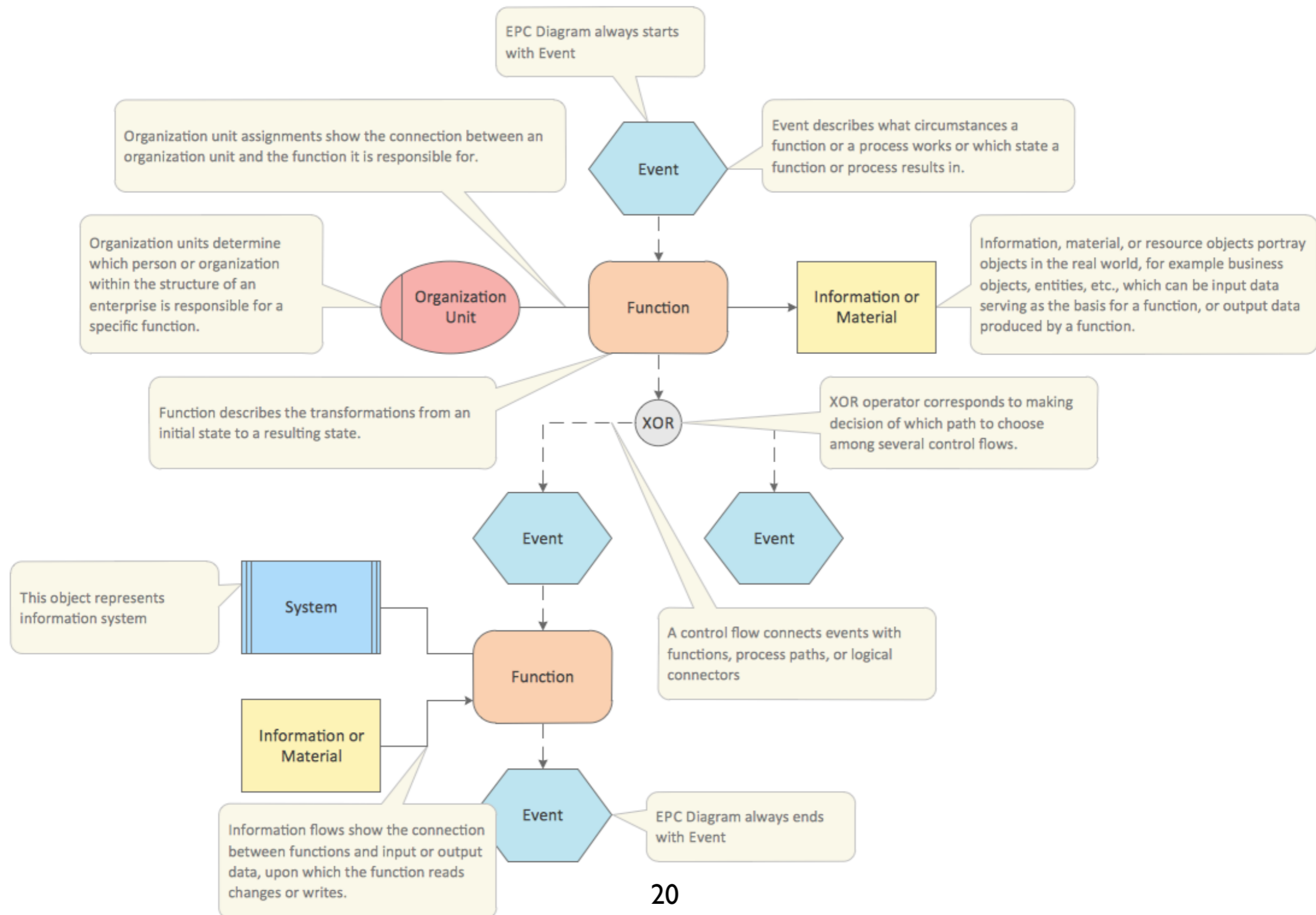

EPC intuitive semantics

A process starts when some initial event(s) occurs

The activities are executed according to the constraints in the diagram

When the process is finished, only final events have not been dealt with

If this is always the case, then the EPC is “correct”

Folder-passing semantics

Semantics

- State: Process folders
- Transition relation:
Propagation of process folders



Folder-passing semantics: events

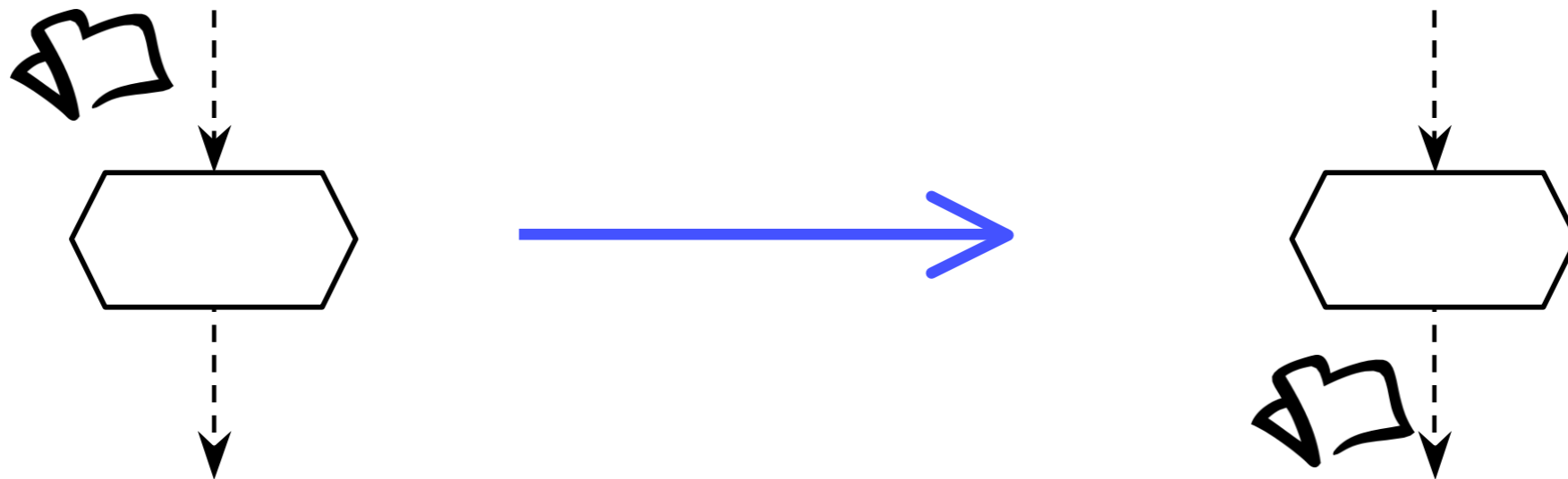

Folder-passing semantics: AND-split

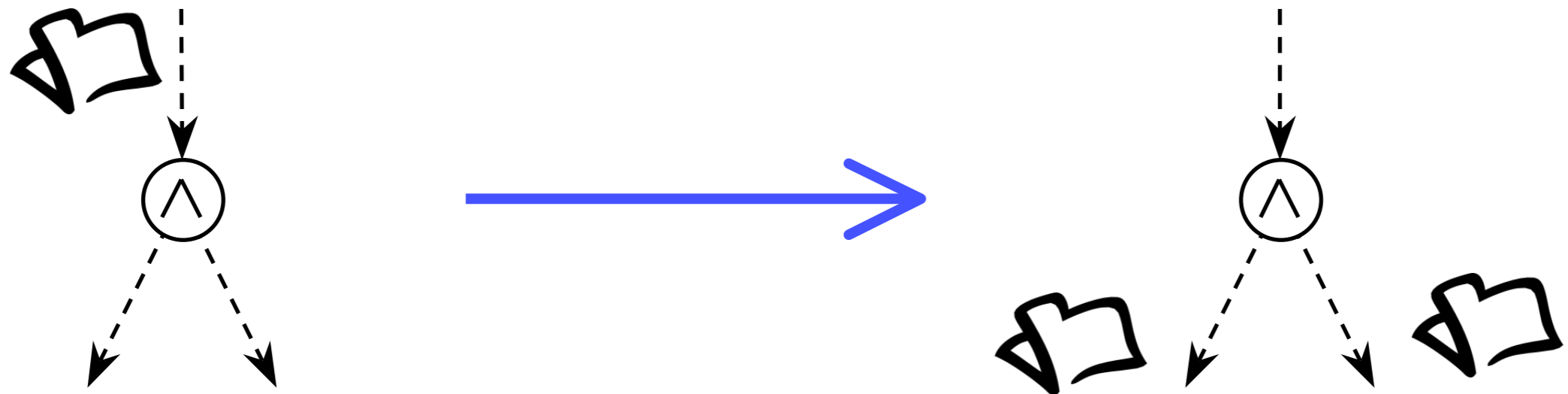

Folder-passing semantics: XOR-split

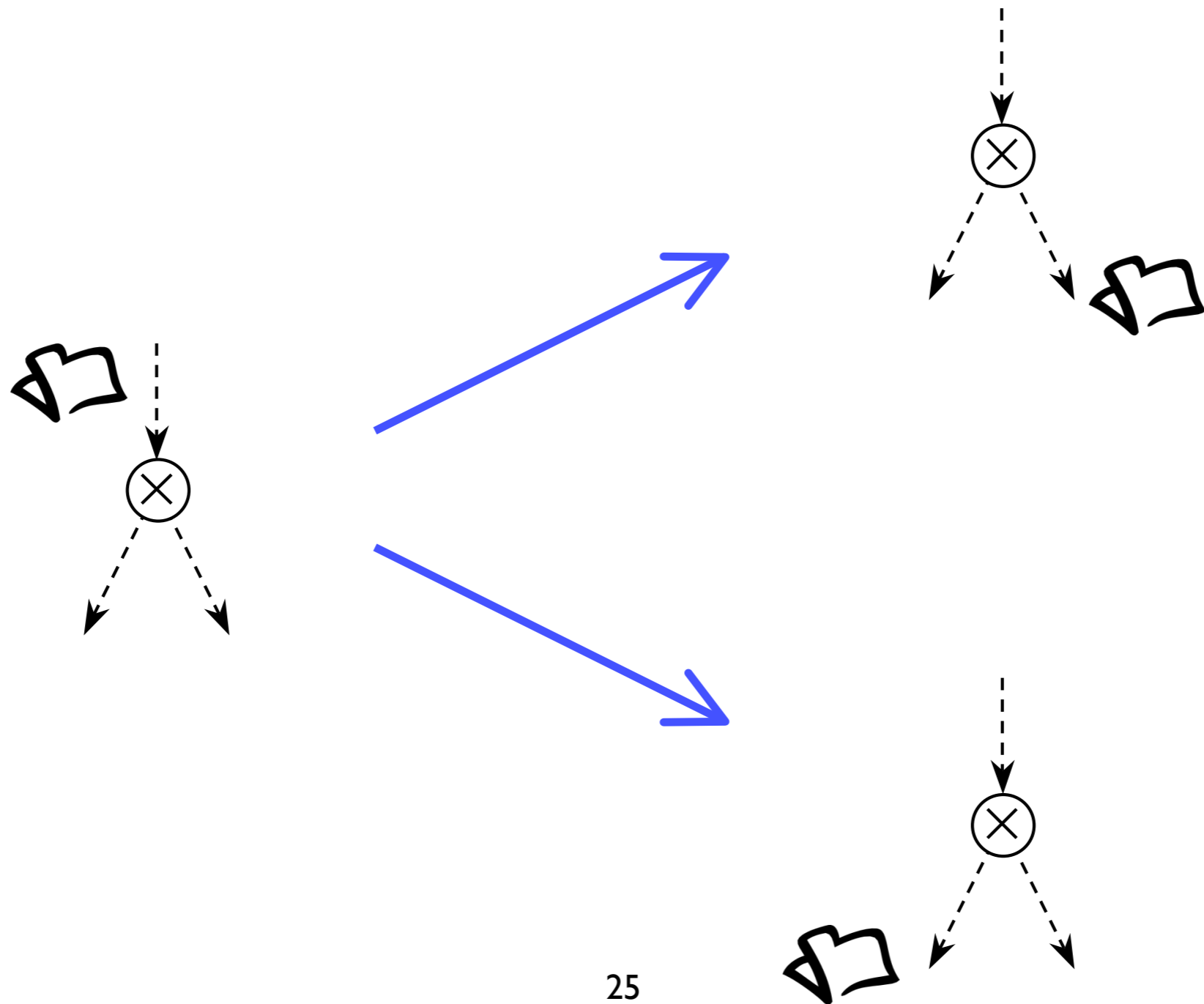

Folder-passing semantics: XOR-join

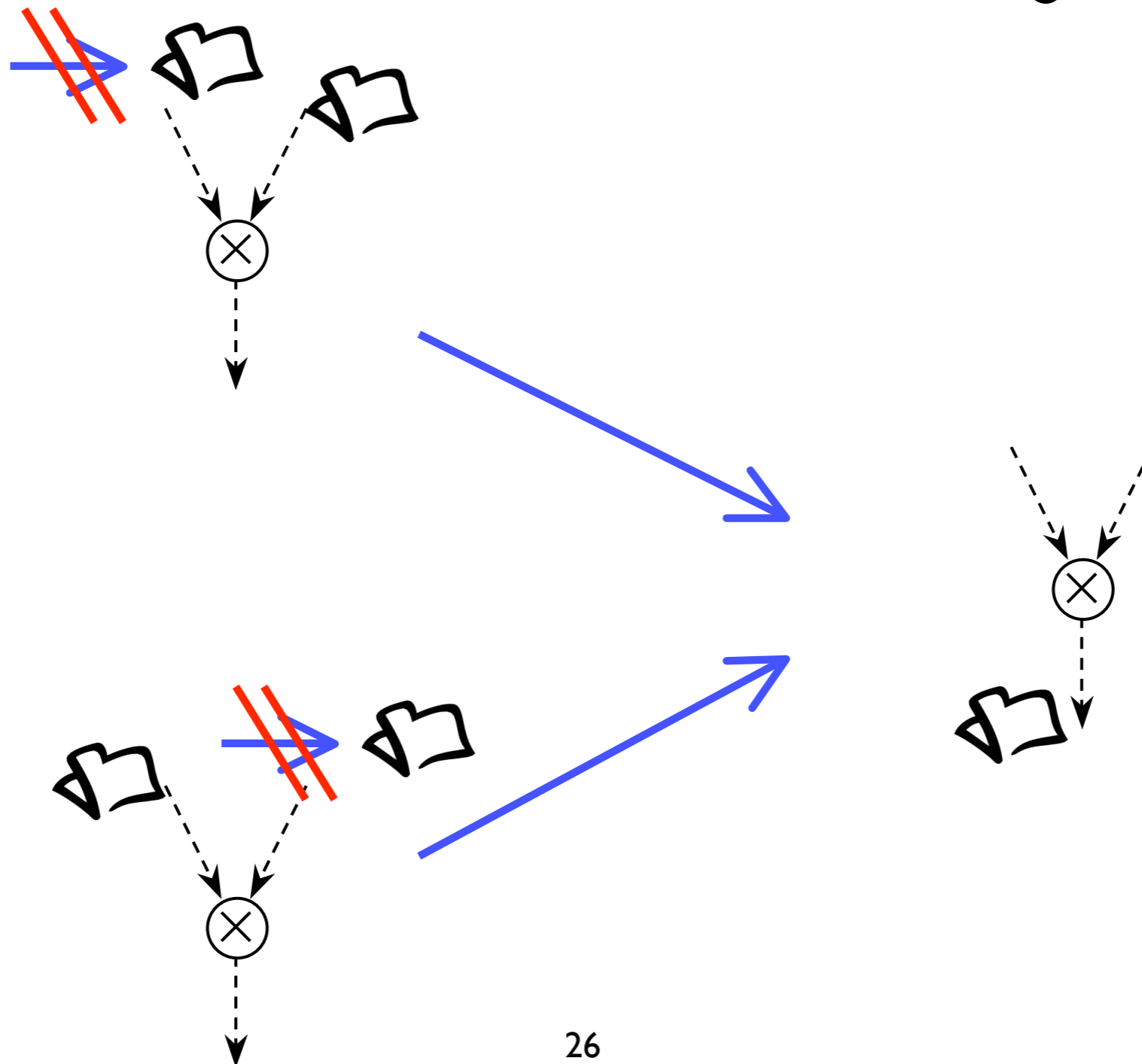

Folder-semantics in one slide

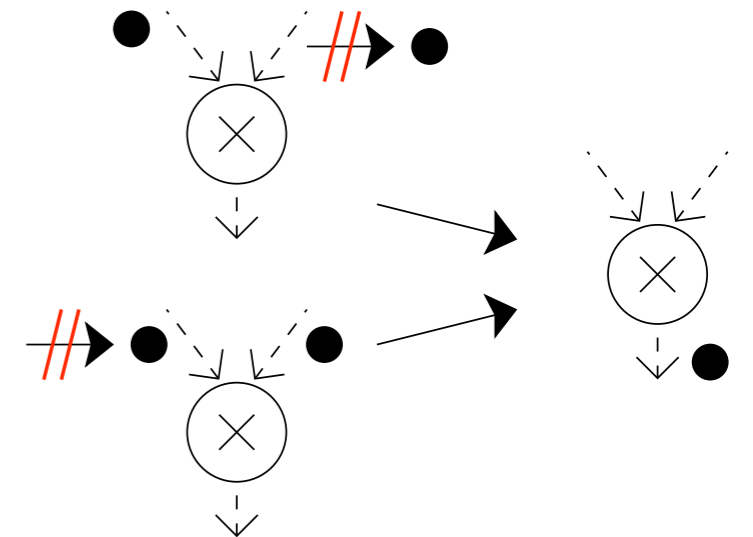
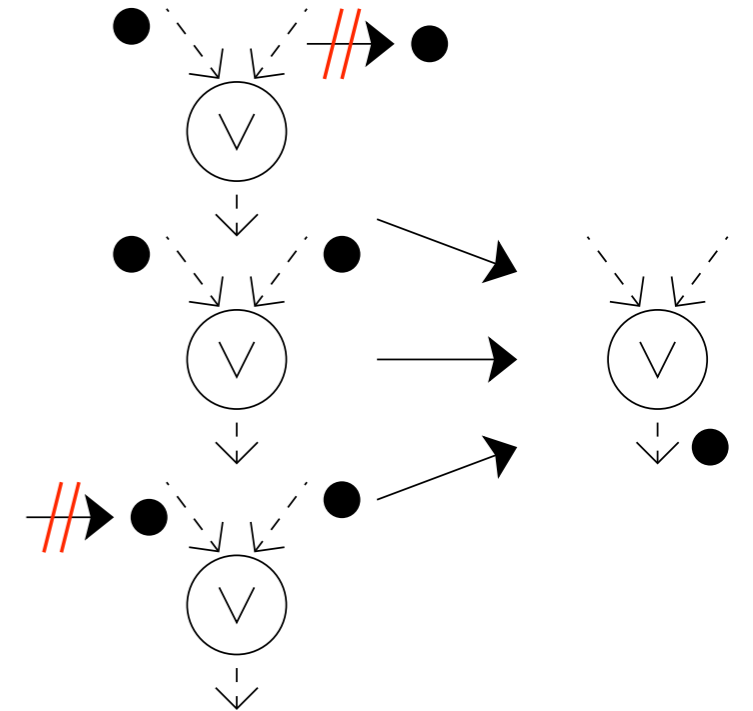
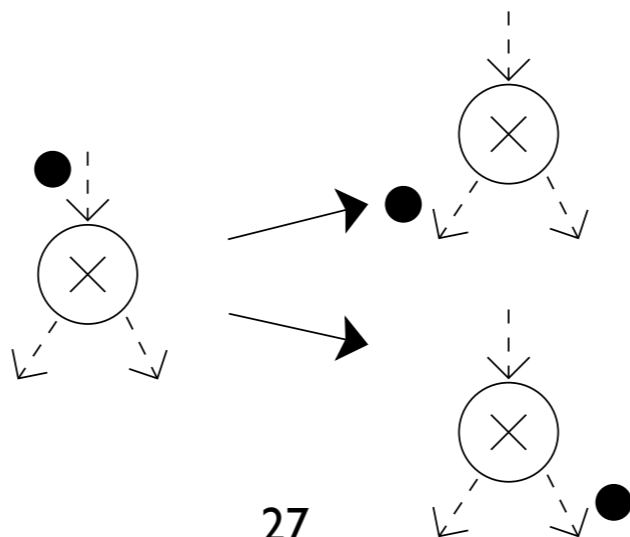
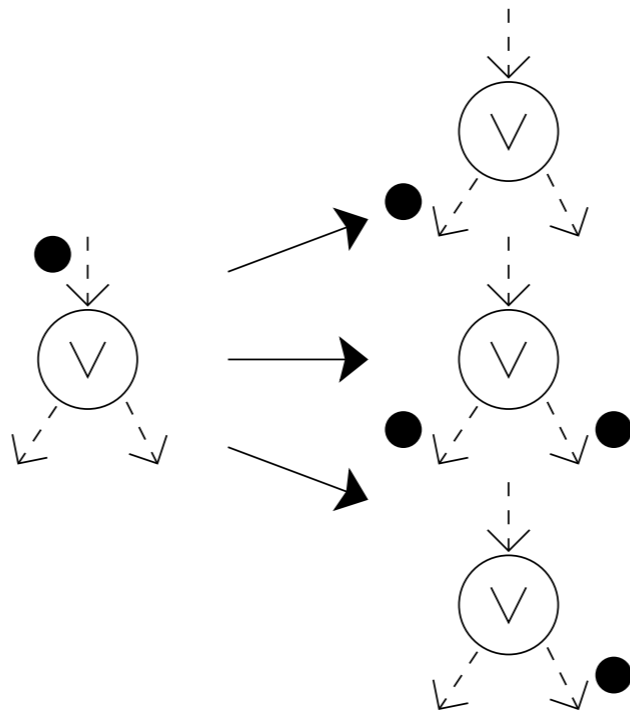
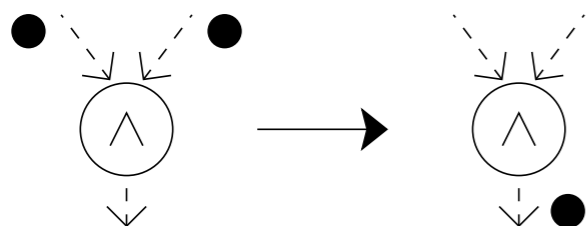
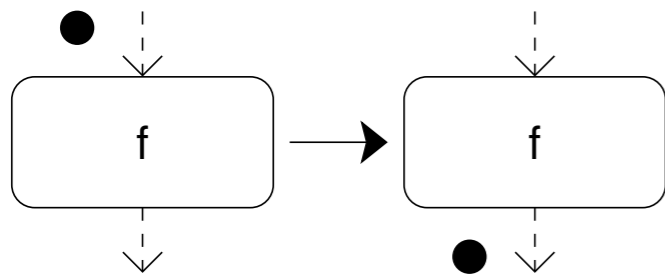
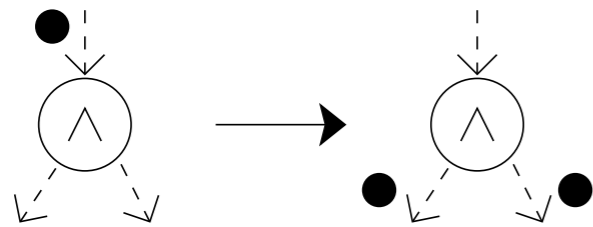
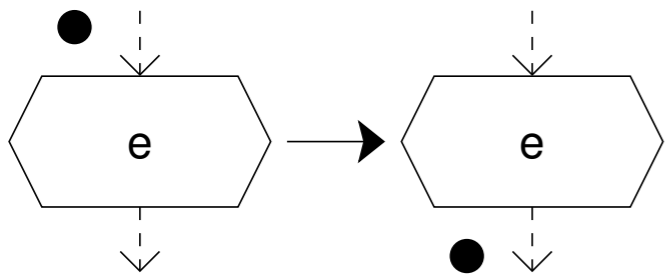

A vicious circle

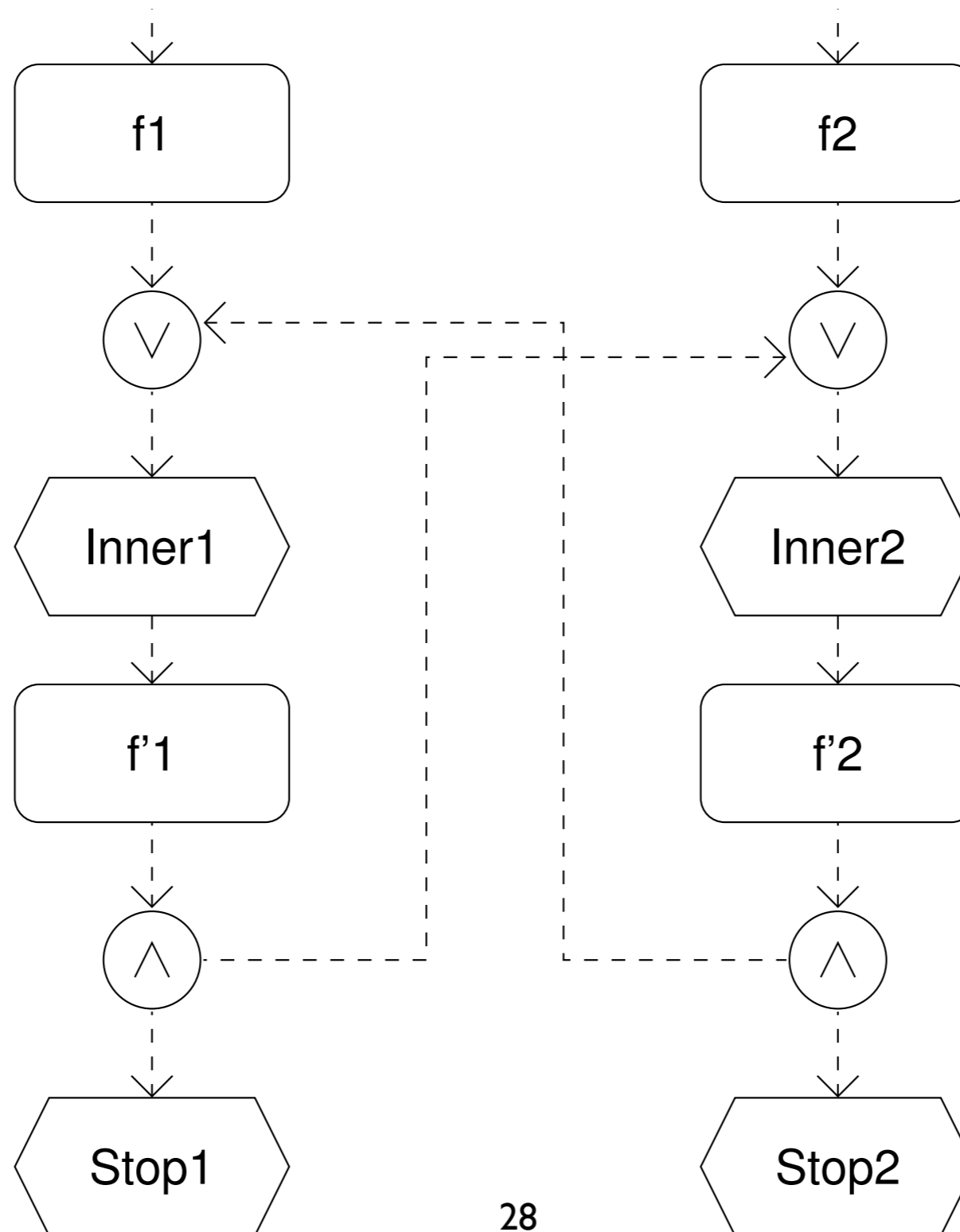

A vicious circle?

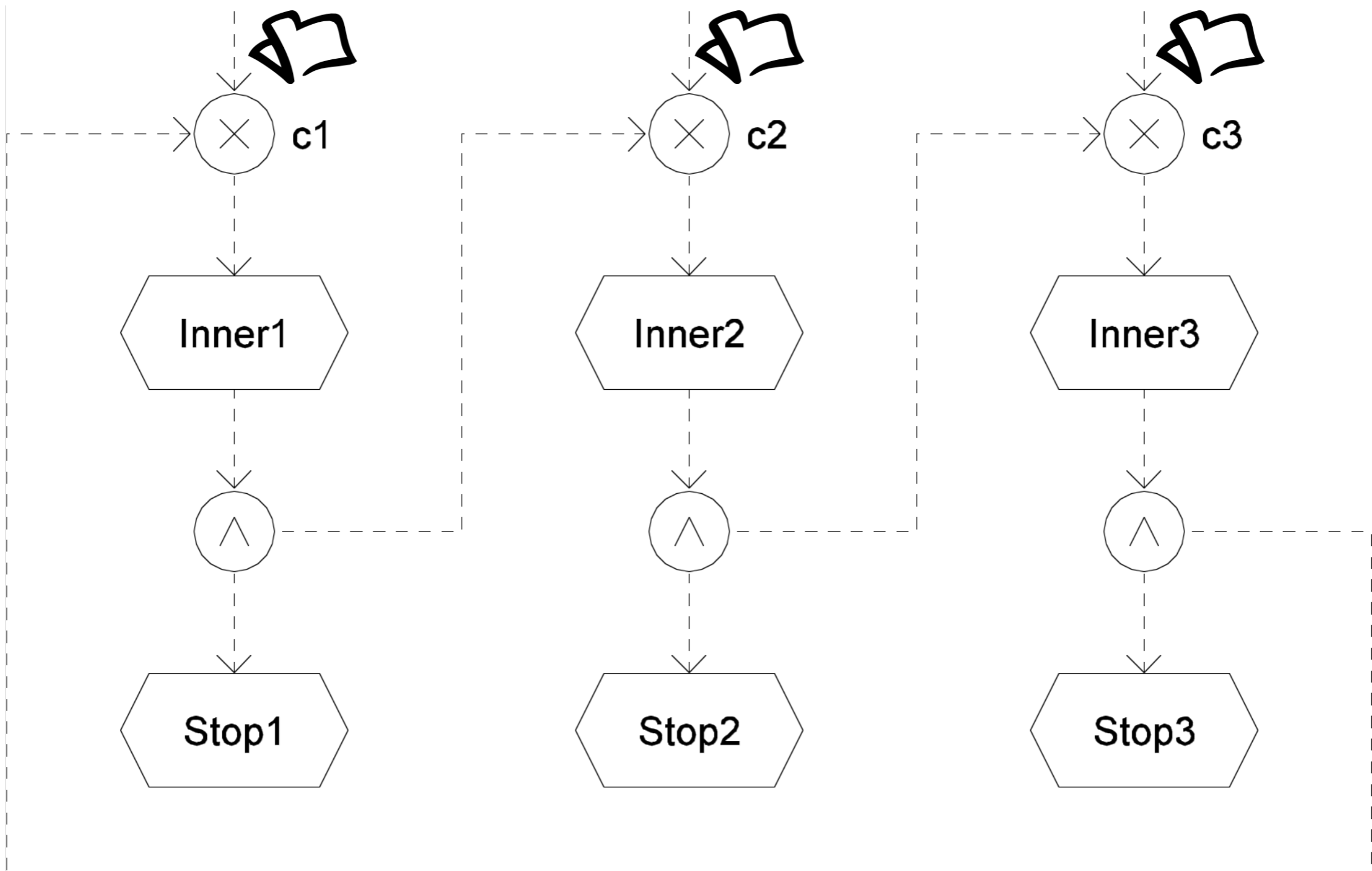

EPC semantics?

Little unanimity around the EPC semantics

Roughly described (verbal form) in the original publication by Scheer (1992)

Later, several attempts to define formal semantics (in many cases they end up attributing different meanings to the same EPC)

Discrepancies typically stem from the interpretation of (X)OR connectors (in particular, join case)
Other issues: unclear start, join/split balancing, alternation of events and functions

Problem with start events

A start event is an event with no incoming arc

A start event invokes a new execution of the process
template

What if multiple start events occur?

Start events are mutually exclusive
(as if they were preceded by an implicit XOR split)

Problem with start events: solution

hypothetical / implicit split

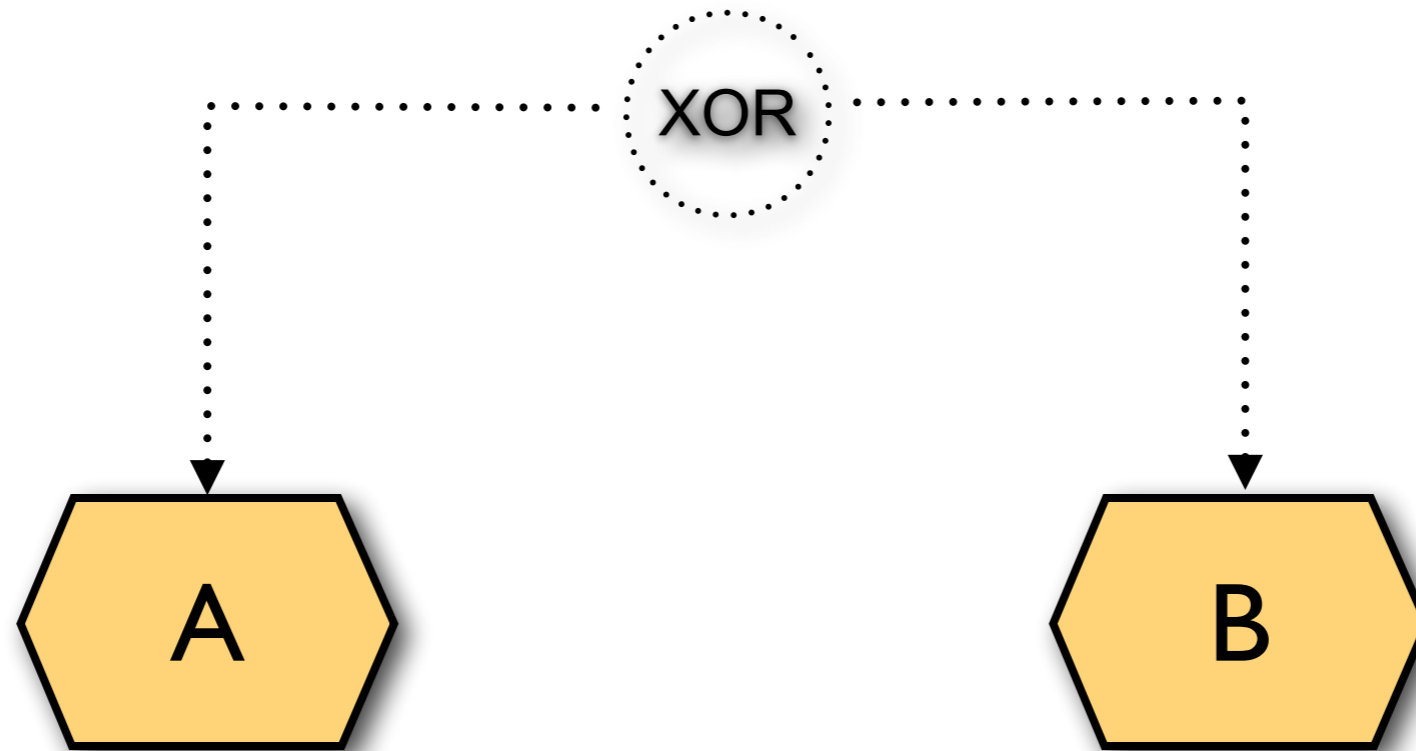

Problem with alternation

Empirical studies have shown that middle and upper management people consider strict alternation between events and functions as too restrictive:
they find it hard to identify the necessary events at the abstract level of process description they are working at

It is safe to drop this requirement,
as dummy events might always be added later, if needed

Every join has a split

In theory, every join has at least one **corresponding** split
(i.e. a split for which there is a path
from either output to the input of the join)

proof:

we trace backward the paths

leading to the join from start events;

if the start events coincide there is a split node in the path;

if start events differ, the candidate split is the implicit XOR

Problem with corresponding splits

The semantics of a join often depends on whether or not it has a corresponding split

But:

- 1) there can be **more candidates** to corresponding split
- 2) and they can have **different type** than the join

candidates of the same type of the join are called
matching split

Some suggested to have a flag that denotes the
corresponding split

Tagging corresponding splits

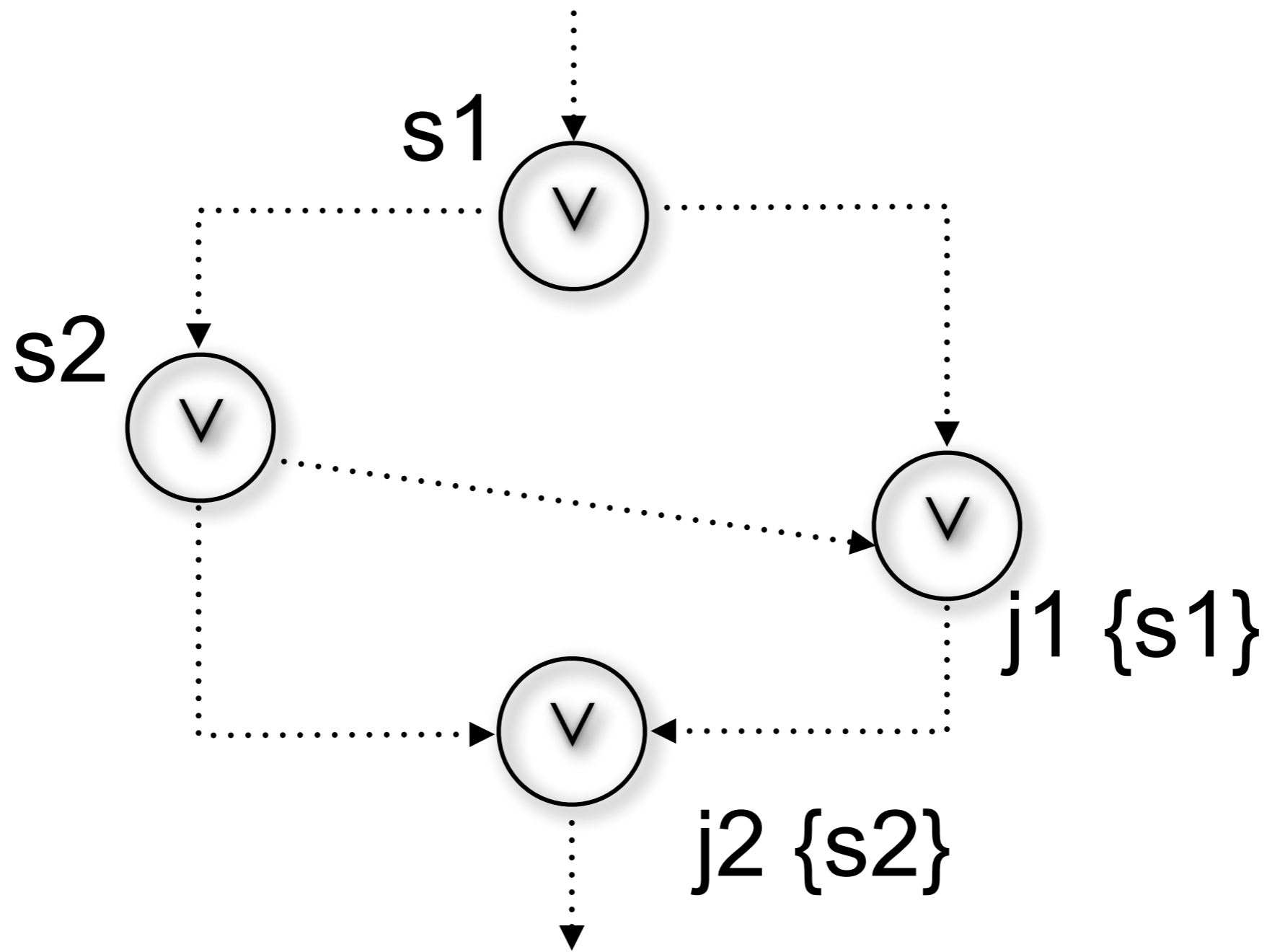

Problem with OR join

If an OR join has a matching split, the semantics is usually:
“wait for the completion of all paths activated by the matching split”

If there is no matching split, some policy must be applied:

wait-for-all: wait for the completion of all *activated* paths
(default semantics, because it coincides with that of a matched OR)

first-come: wait only for the path that is completed first
and ignore the second

every-time: trigger the outgoing path on each completion
(the outgoing path can be activated multiple times)

Some suggested to have different (trapezoid) symbols or
suitable flags to distinguish the above cases and allow them all

Problem with XOR join

Similar considerations hold for the XOR join

If a XOR join has a matching split, the semantics is intuitive:
“it blocks if both paths are activated and it is triggered by the completion of a single activated path”

If there is no matching split:

all feasible interpretations that do not involve blocking are already covered by the OR (wait-for-all, first-come, every-time)

and **contradict the exclusivity** of the XOR

(a token from one path can be accepted only if we make sure that no second token will arrive via the other path)

Some suggest to just forbid the use of XOR in the unmatched case
(the implicit start split is allowed as a valid match)

Translation of EPC to Petri nets

Idea

We transform EPC diagrams to Workflow nets

We exploit the formal semantics of nets
to give unambiguous semantics to EPC diagrams

We apply the verification tools we have seen
to check if the net is sound:

the EPC diagram is sound if its net is so

A note about the transformation

We first transform each event, function and connector separately in small net fragments

When translating the control flow arcs we may then introduce other places / transitions to preserve the bipartite structure in the net
(no arc allowed between two places,
no arc allowed between two transitions)

We show two translations, depending on whether joins are decorated or not

First attempt
(decorated EPC)

EPC

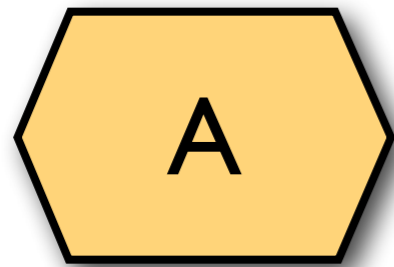

event

Petri net

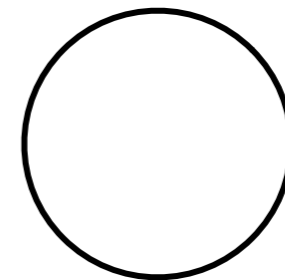

place

EPC



function

Petri net



transition

EPC

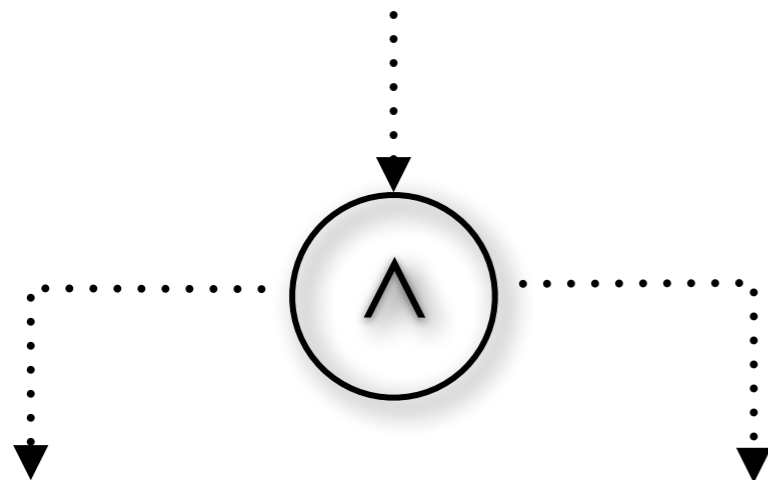

AND split

Petri net

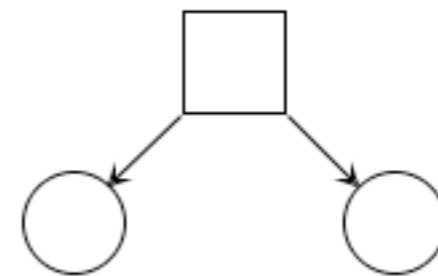

net

EPC

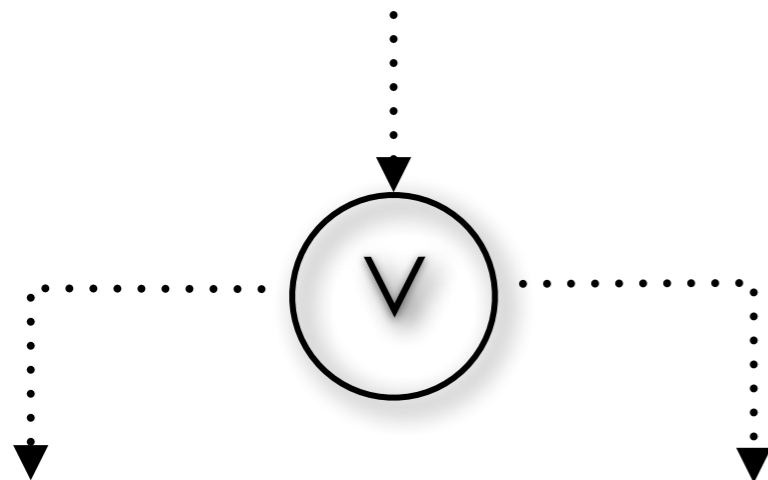

OR split

Petri net

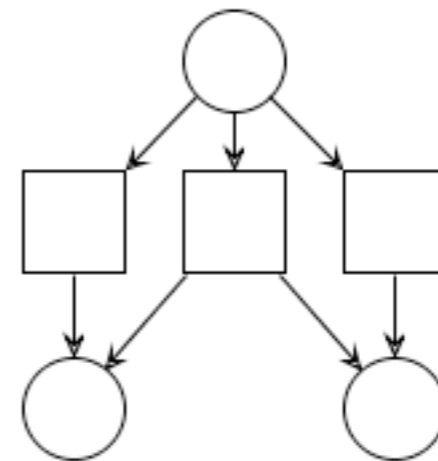

net

EPC

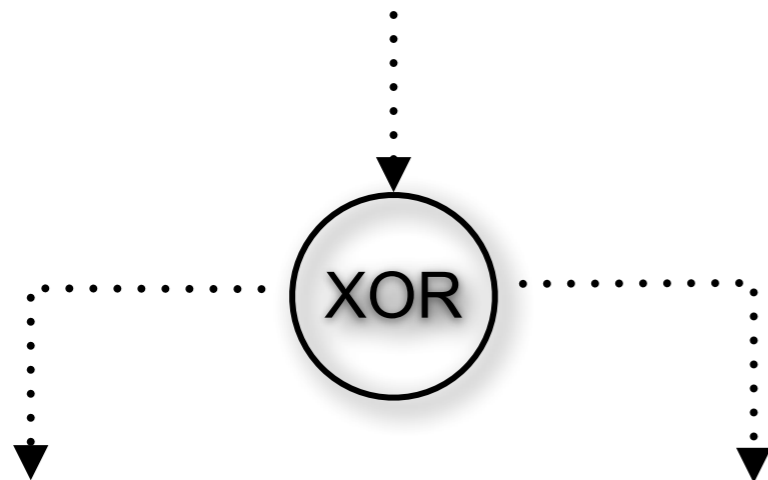

XOR split

Petri net

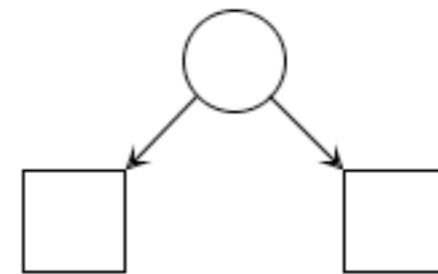

net

EPC

Petri net

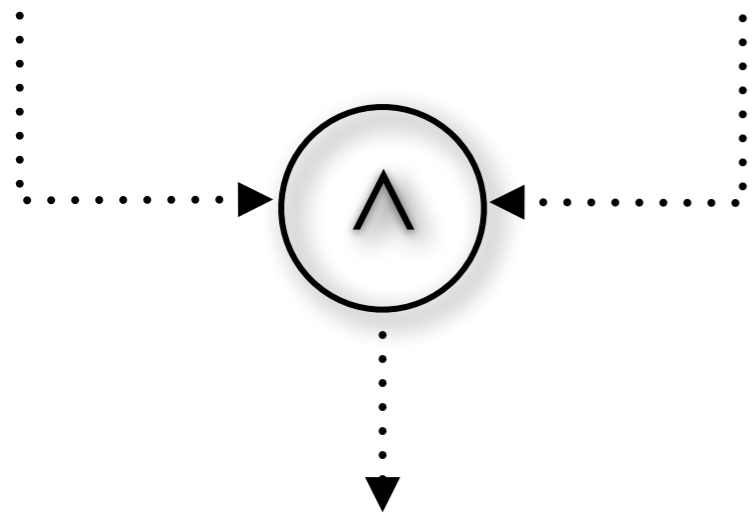

AND join

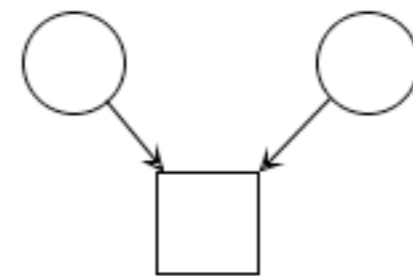

net

EPC

Petri net

corresponding
split

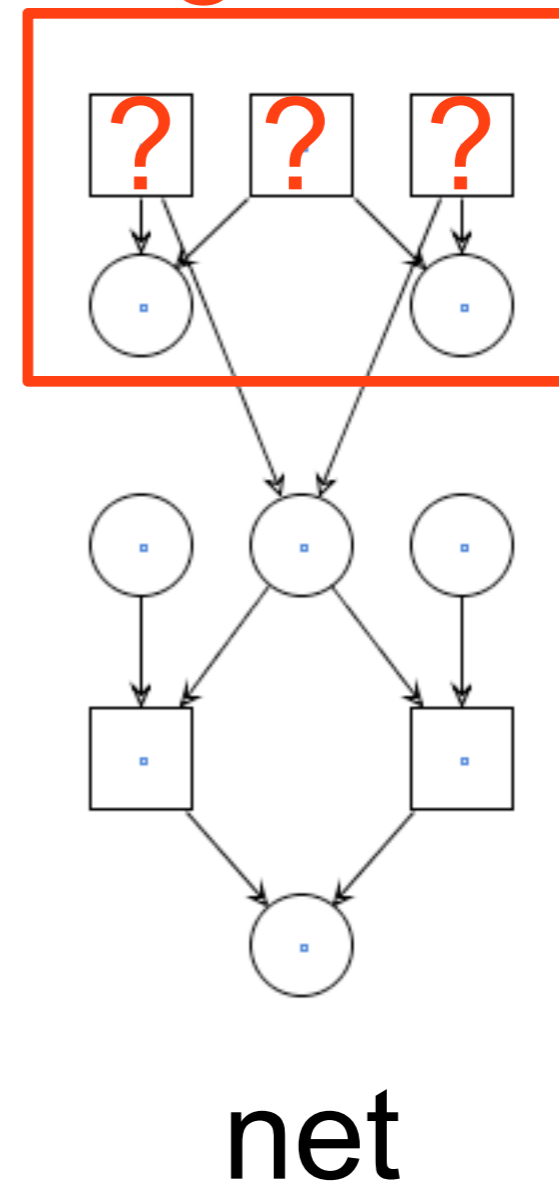
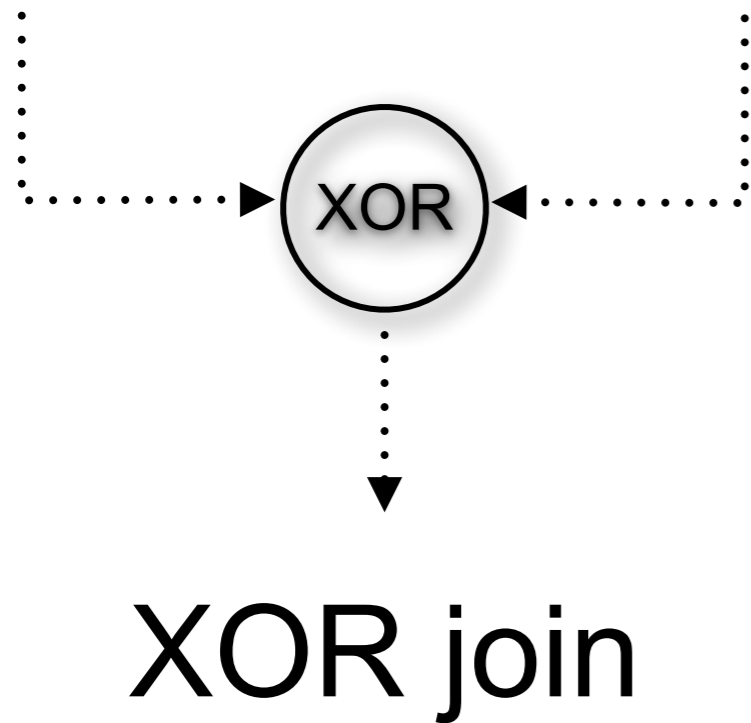

EPC

Petri net

corresponding
XOR/OR split

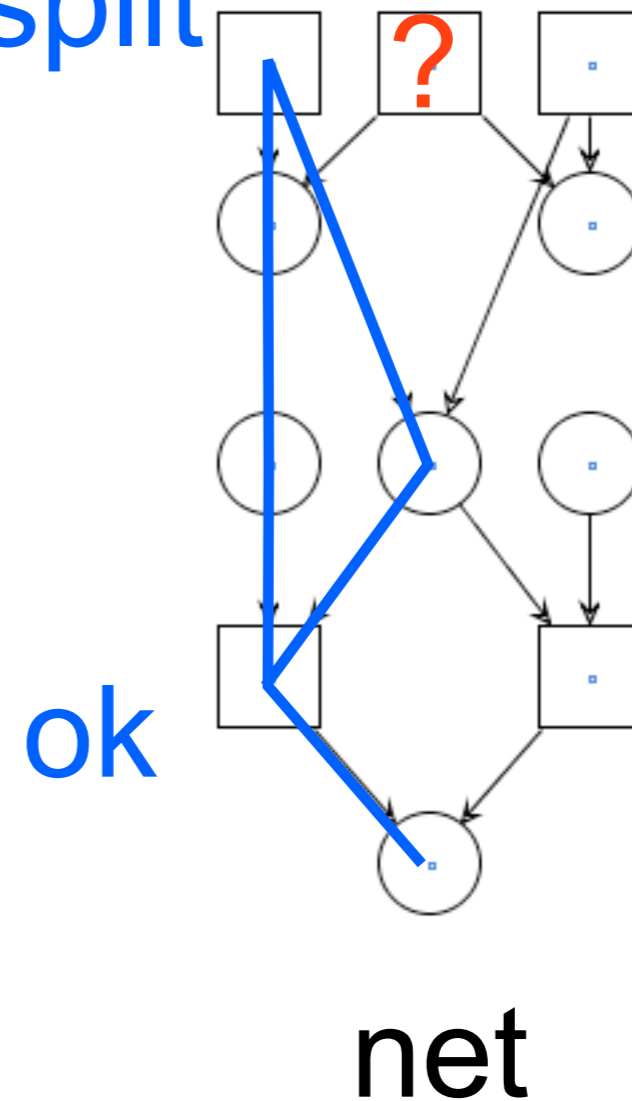
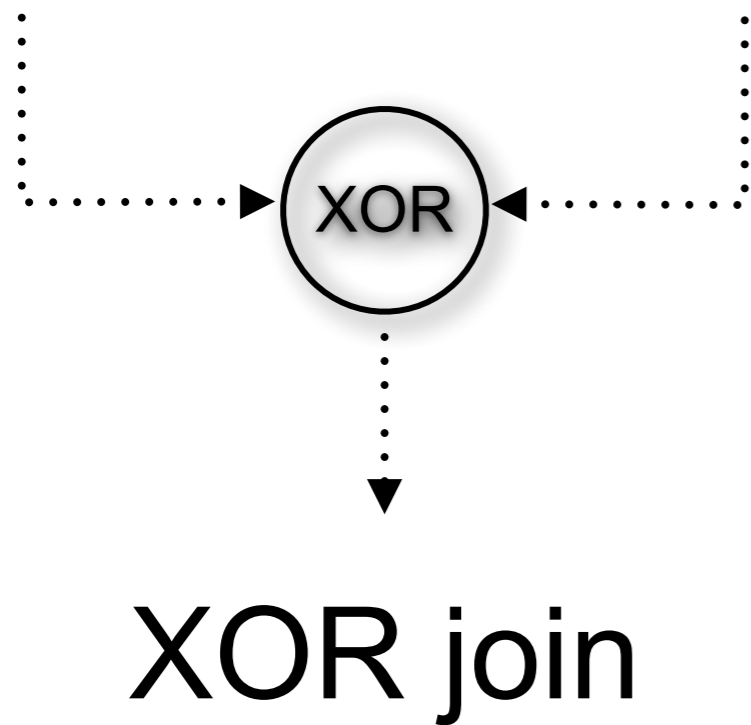

EPC

Petri net

corresponding
AND/OR split

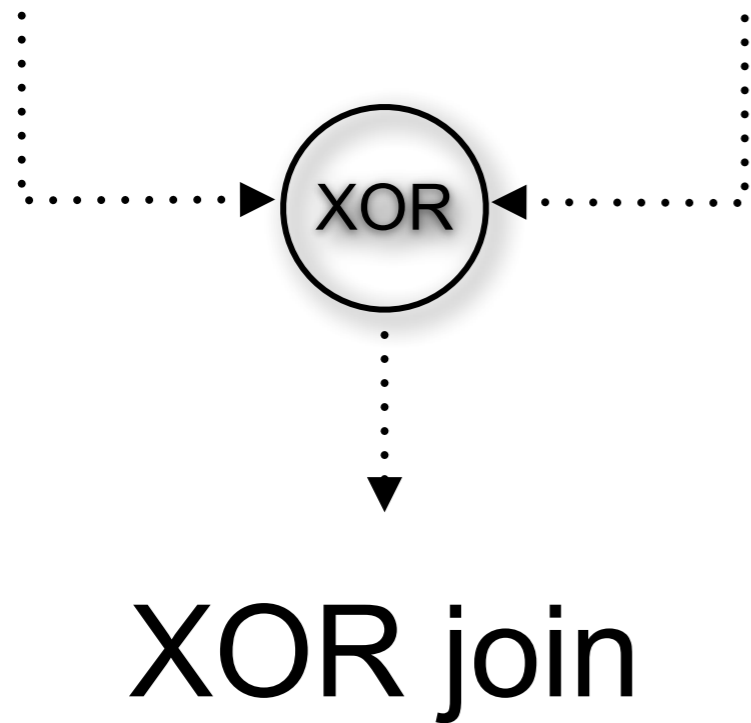

deadlock!

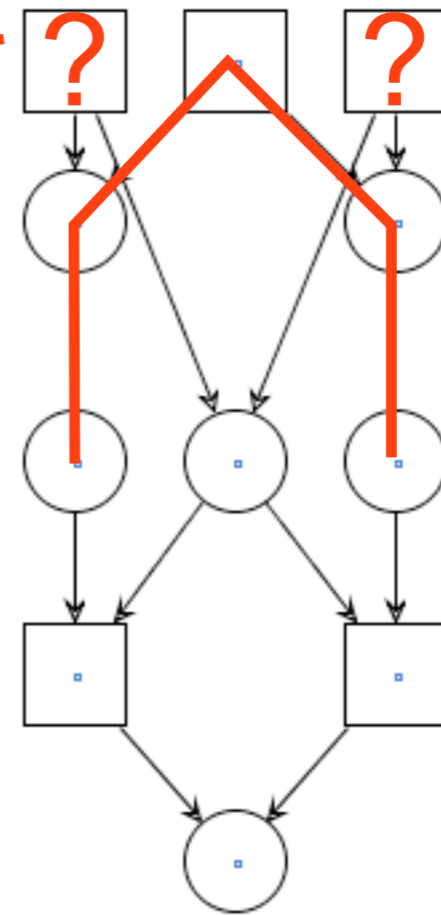

dangling
tokens!

net

EPC

Petri net

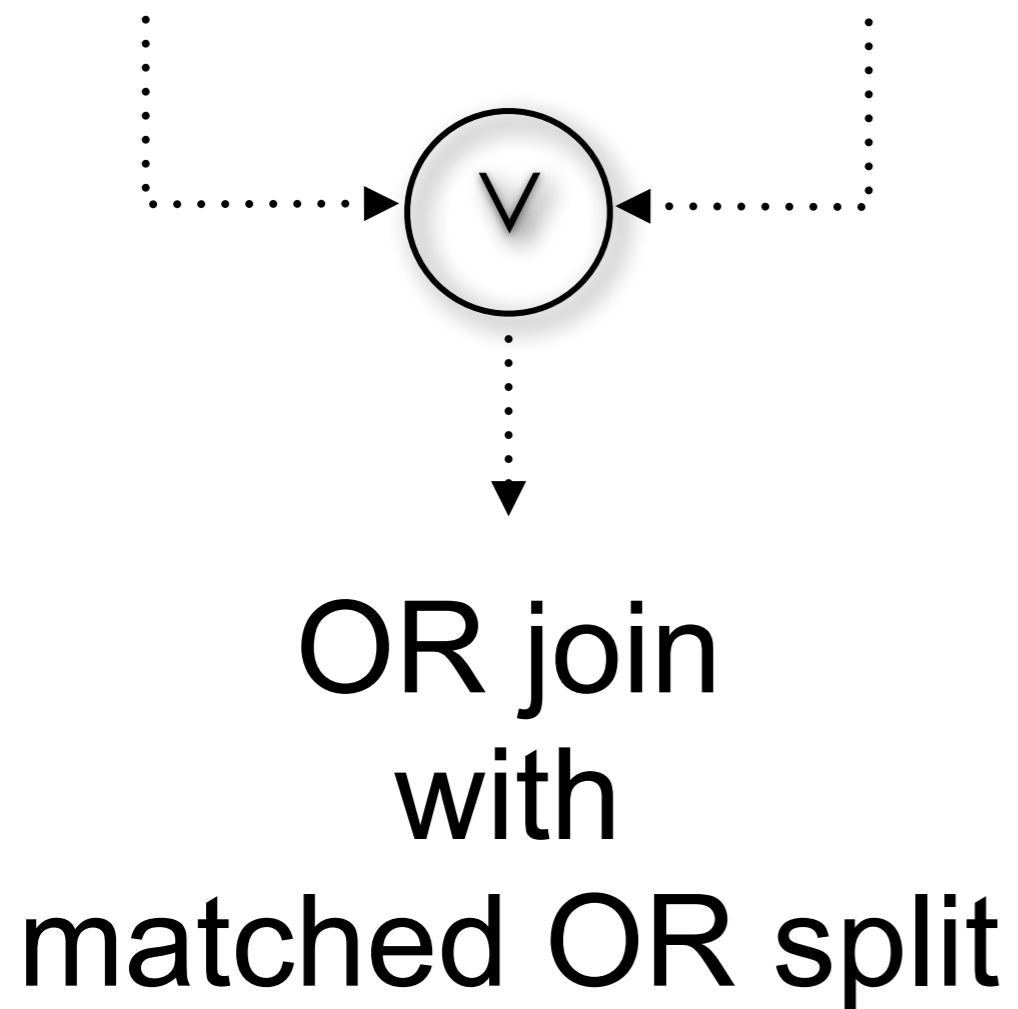

matched
part

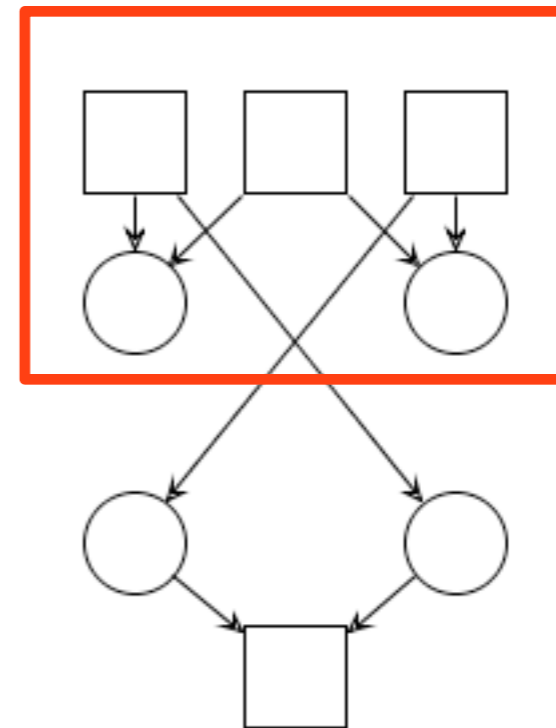

net

EPC

Petri net

corresponding
split

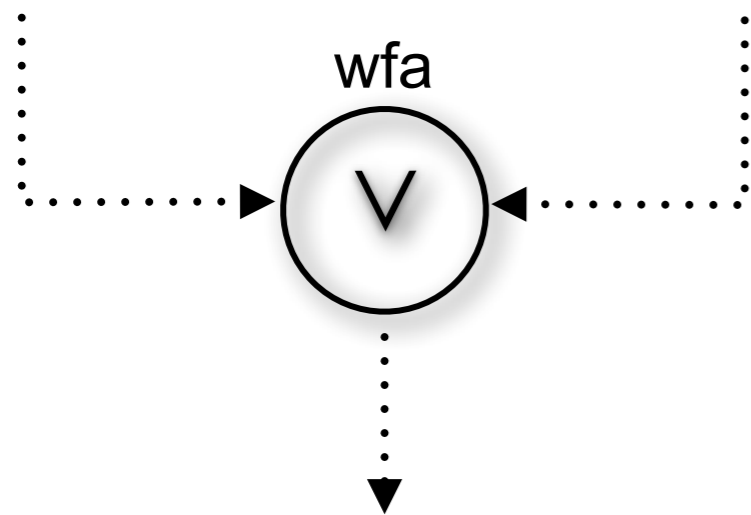

OR join
wait-for-all
(unmatched)

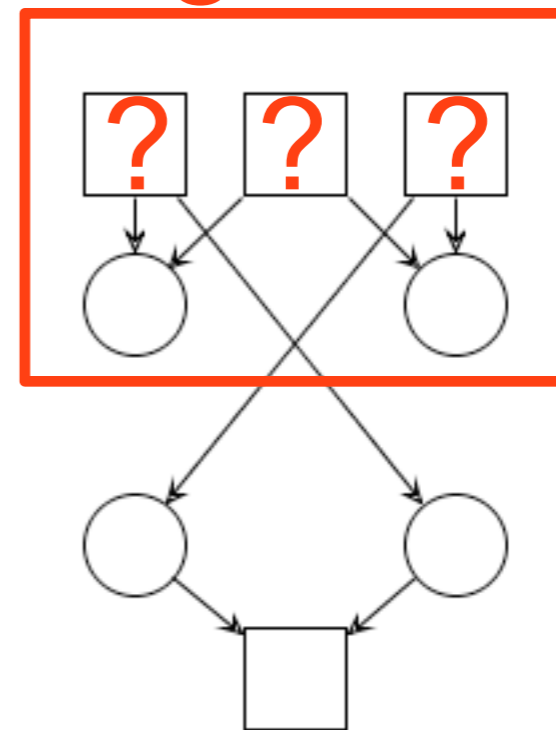

net

EPC

Petri net

corresponding
AND split

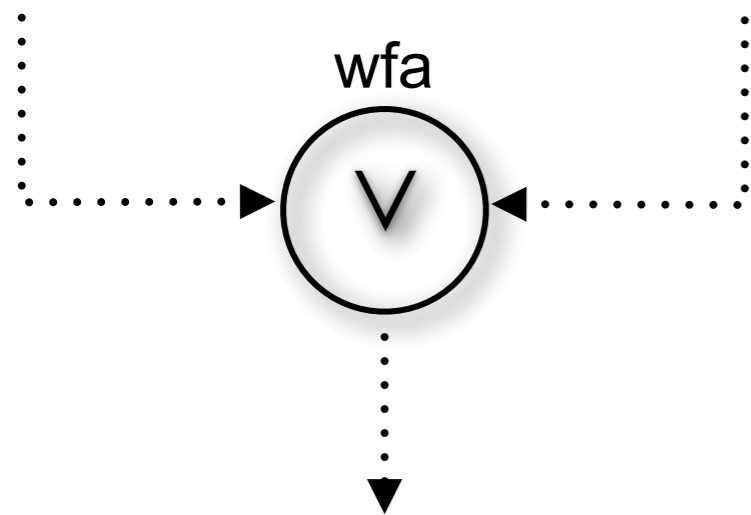

OR join
wait-for-all
(unmatched)

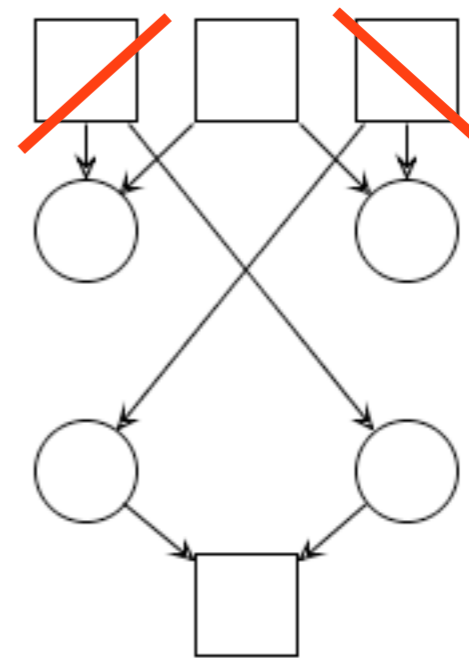

net

EPC

Petri net

corresponding
XOR split

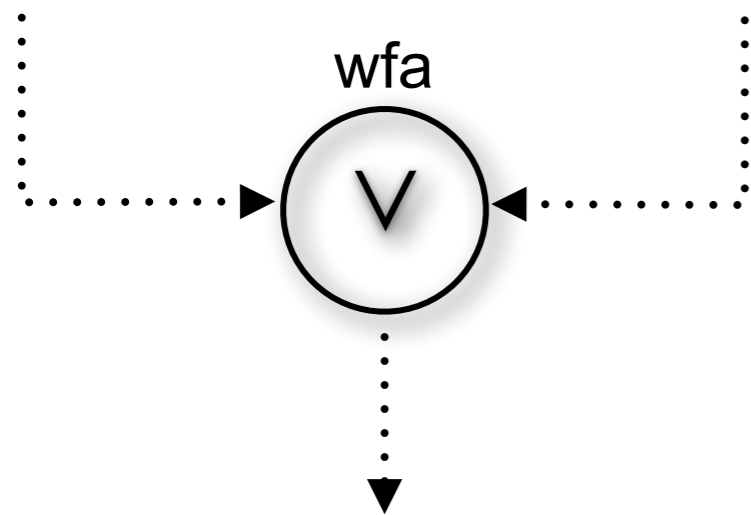

OR join
wait-for-all
(unmatched)

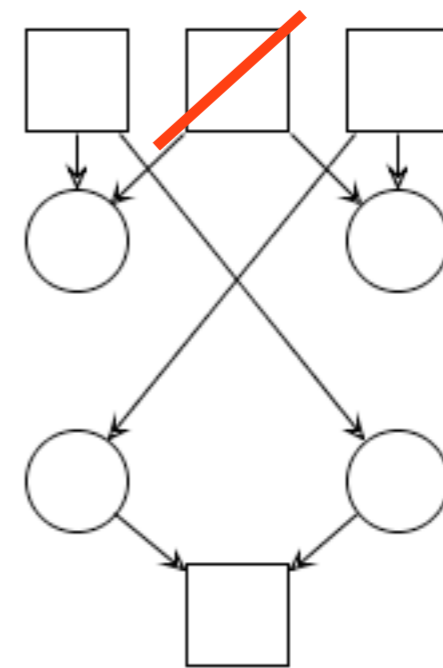

net

EPC

Petri net

corresponding
split

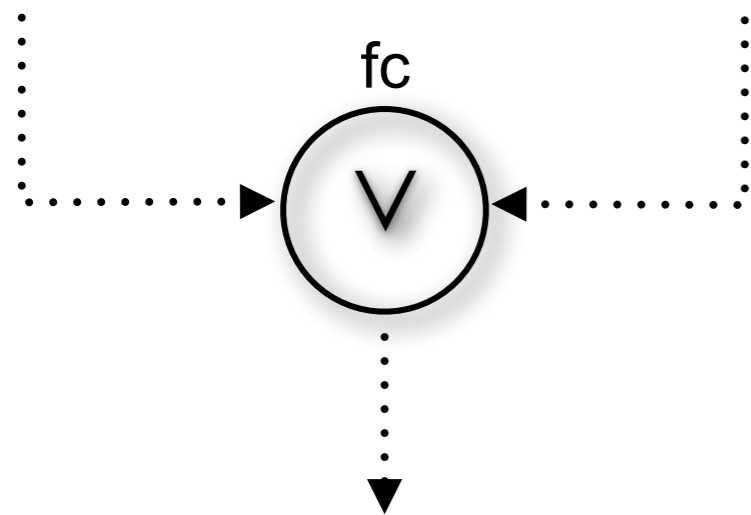

OR join
first-come
(unmatched)

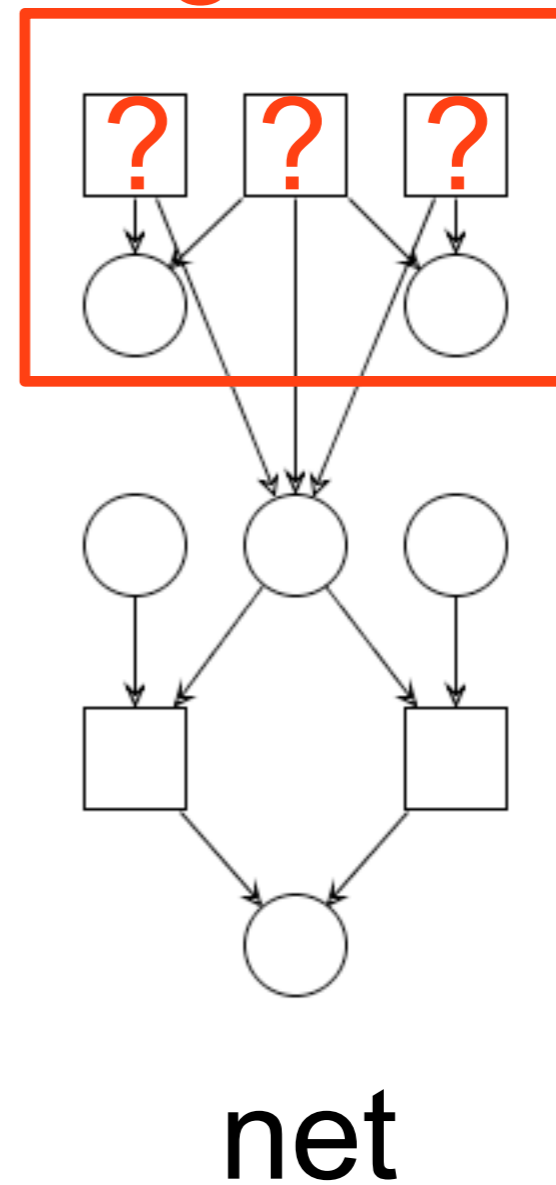

net

EPC

Petri net

corresponding
XOR split

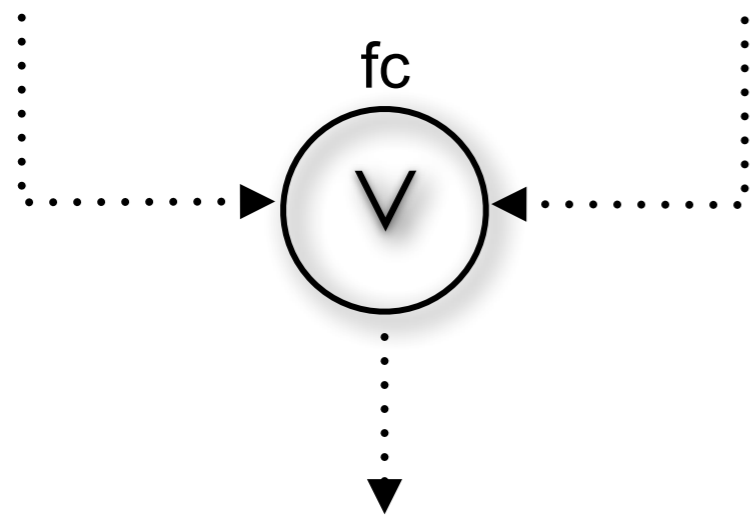

OR join
first-come
(unmatched)

ok

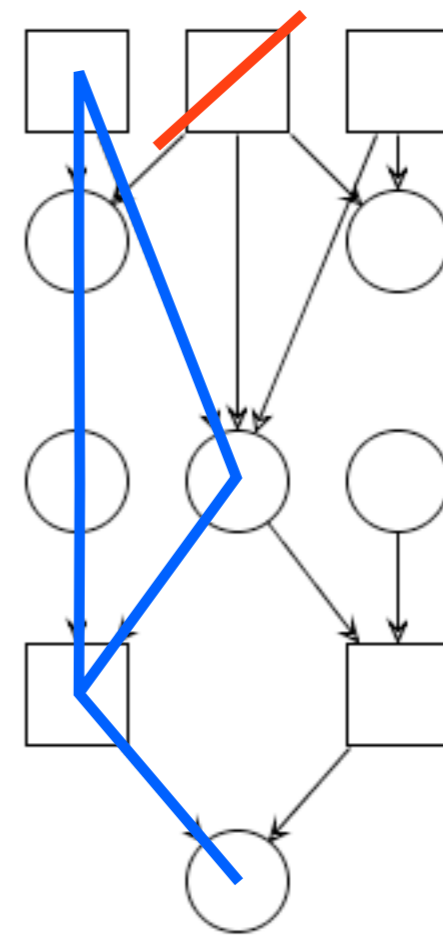

net

EPC

Petri net

corresponding
AND split

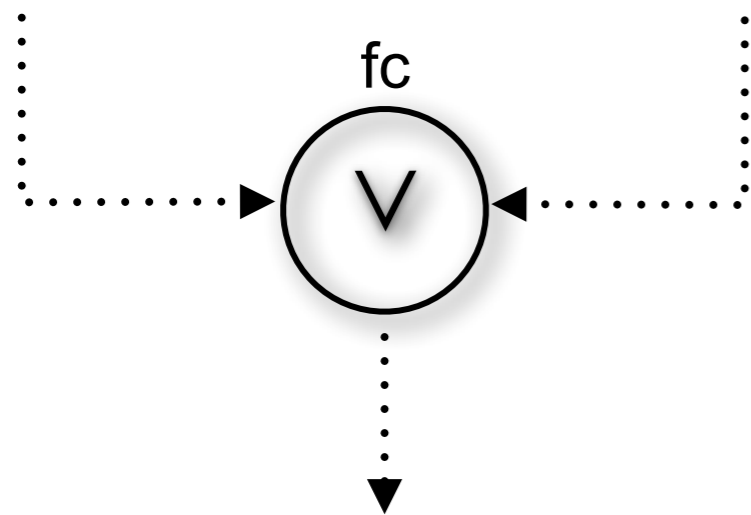

OR join
first-come
(unmatched)

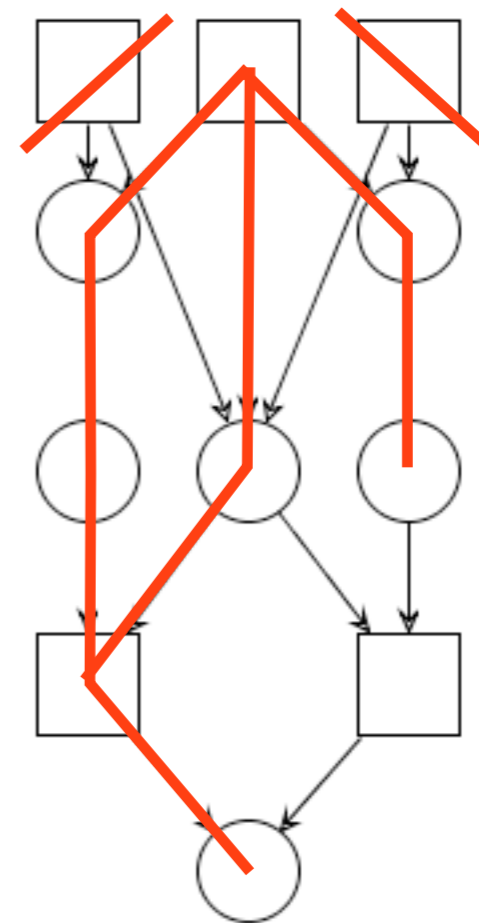

dangling
token!

net

EPC

Petri net

corresponding
split

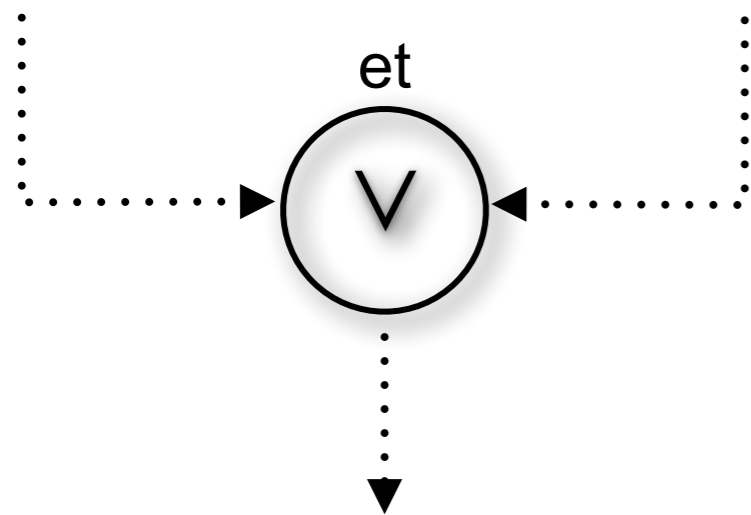

OR join
every-time
(unmatched)

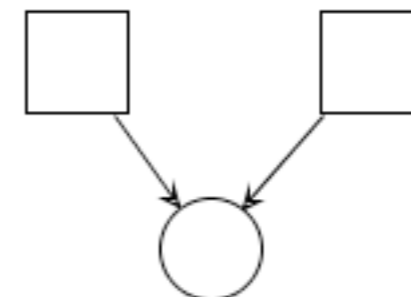
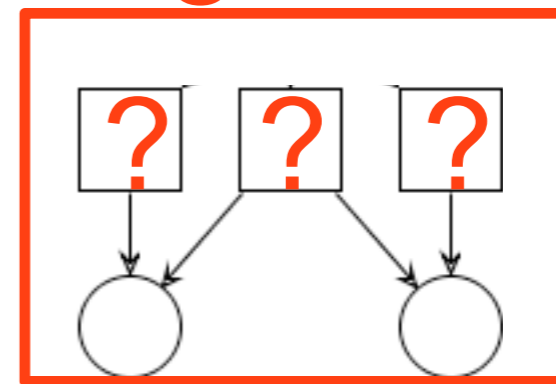

net

EPC

Petri net

corresponding
XOR split

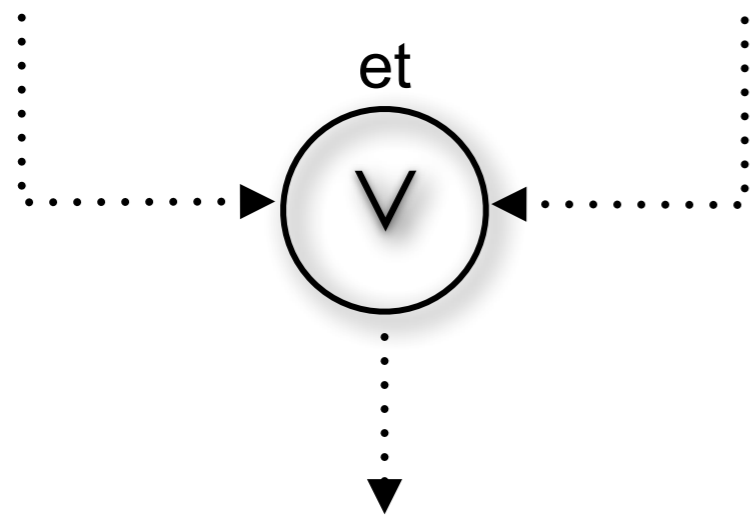

OR join
every-time
(unmatched)

ok

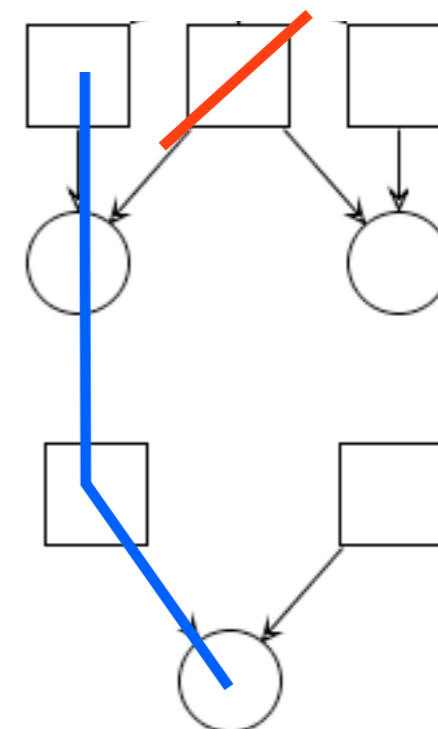

EPC

Petri net

corresponding
AND split

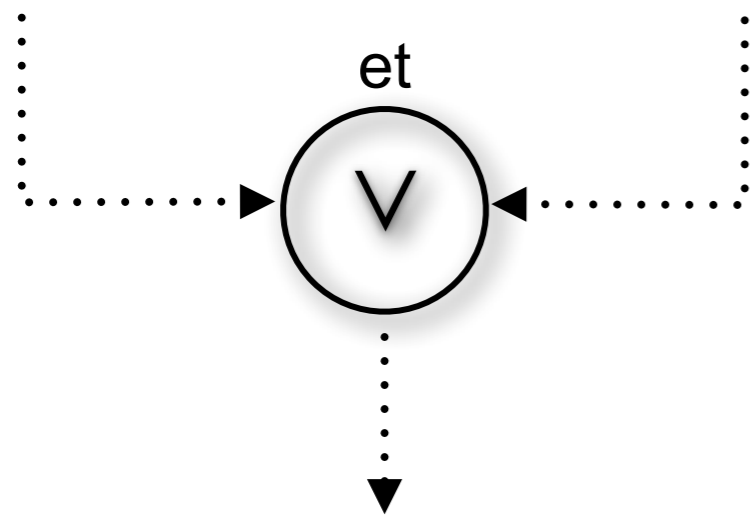

OR join
every-time
(unmatched)

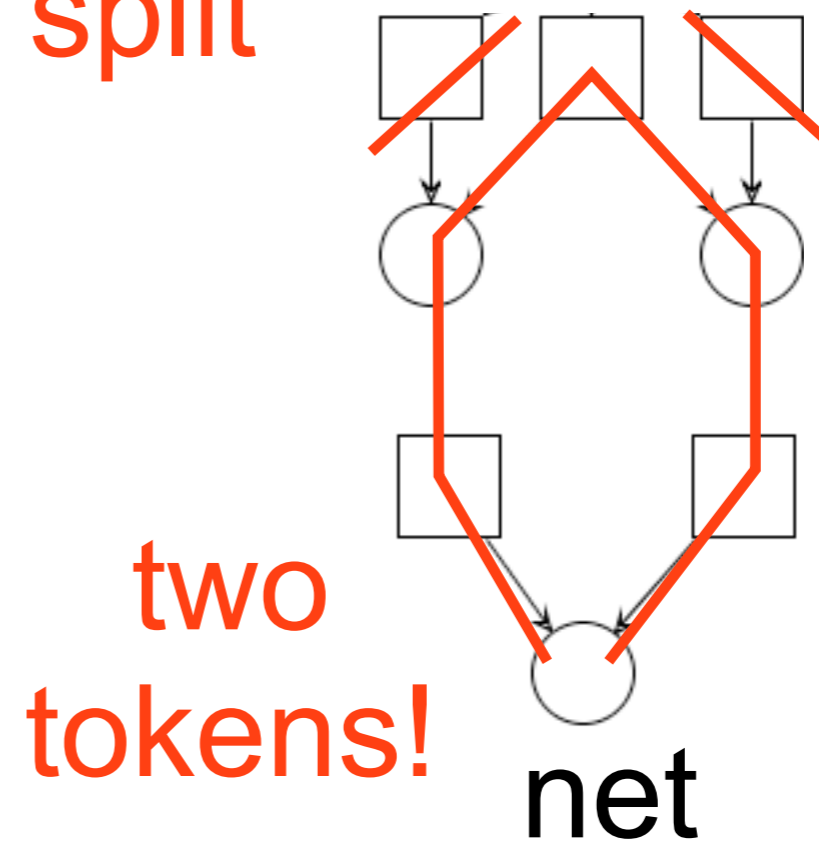

split

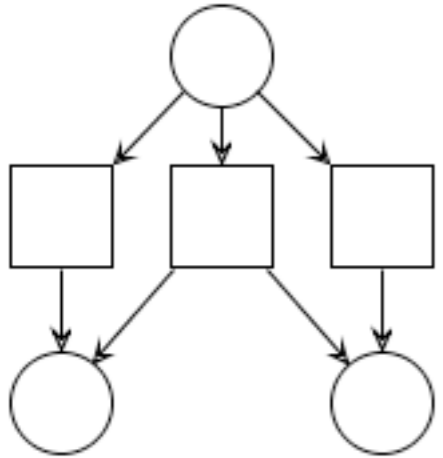
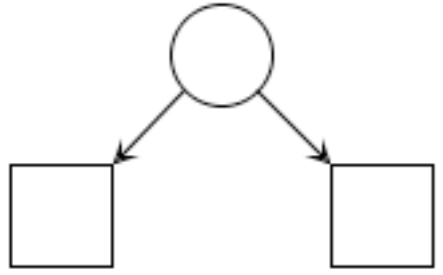
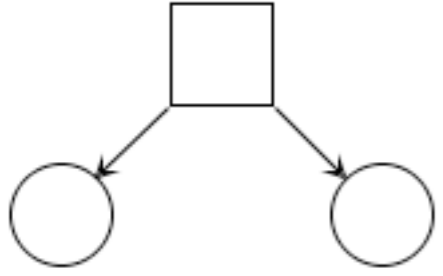

join

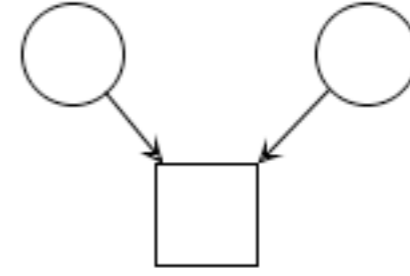

corresp.
split

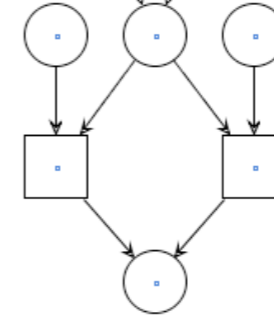
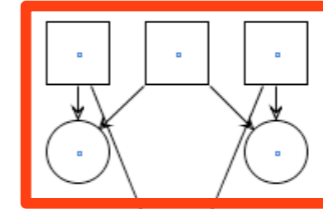

matched
OR split

corresp.
split: wfa

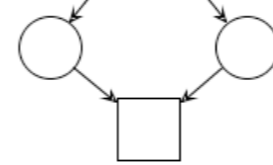
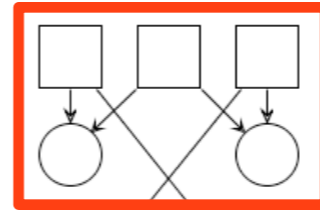

corresp.
split: fc

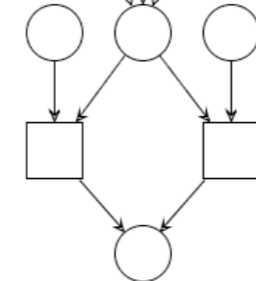
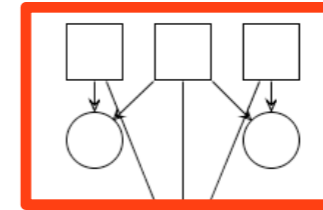

corresp.
split: et

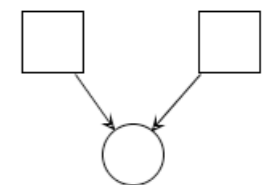
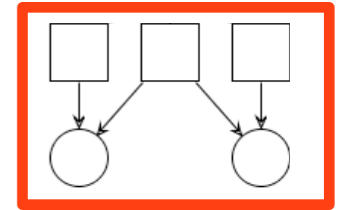

Ill-formed net

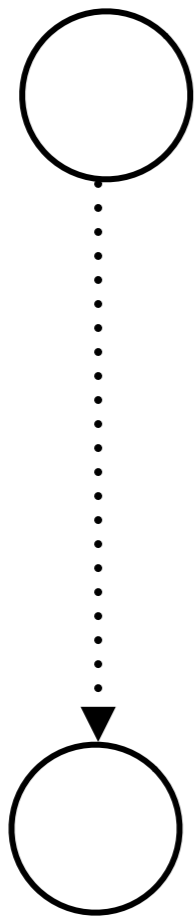

Petri net

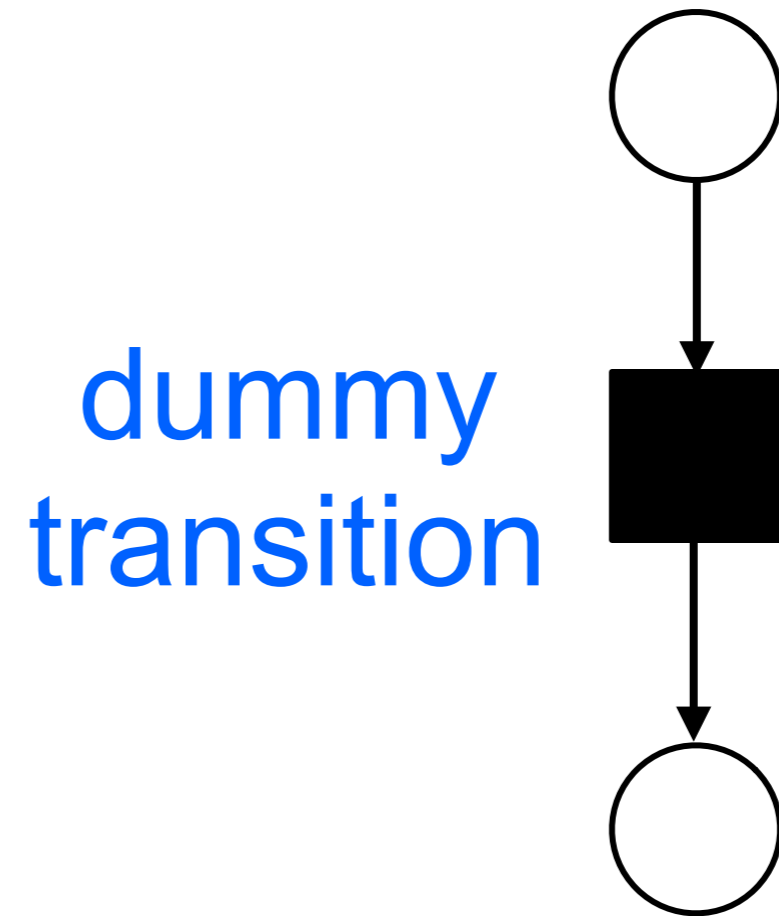

Ill-formed net

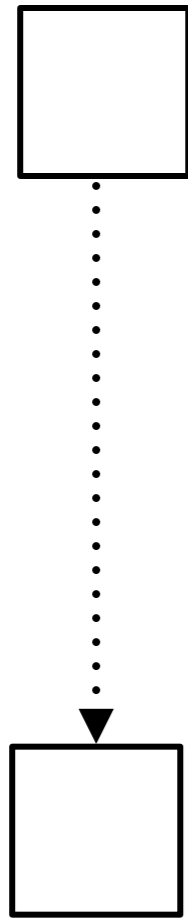

Petri net

dummy
place

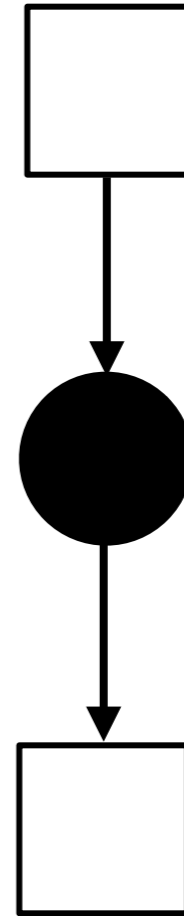

Exercise

Sound?

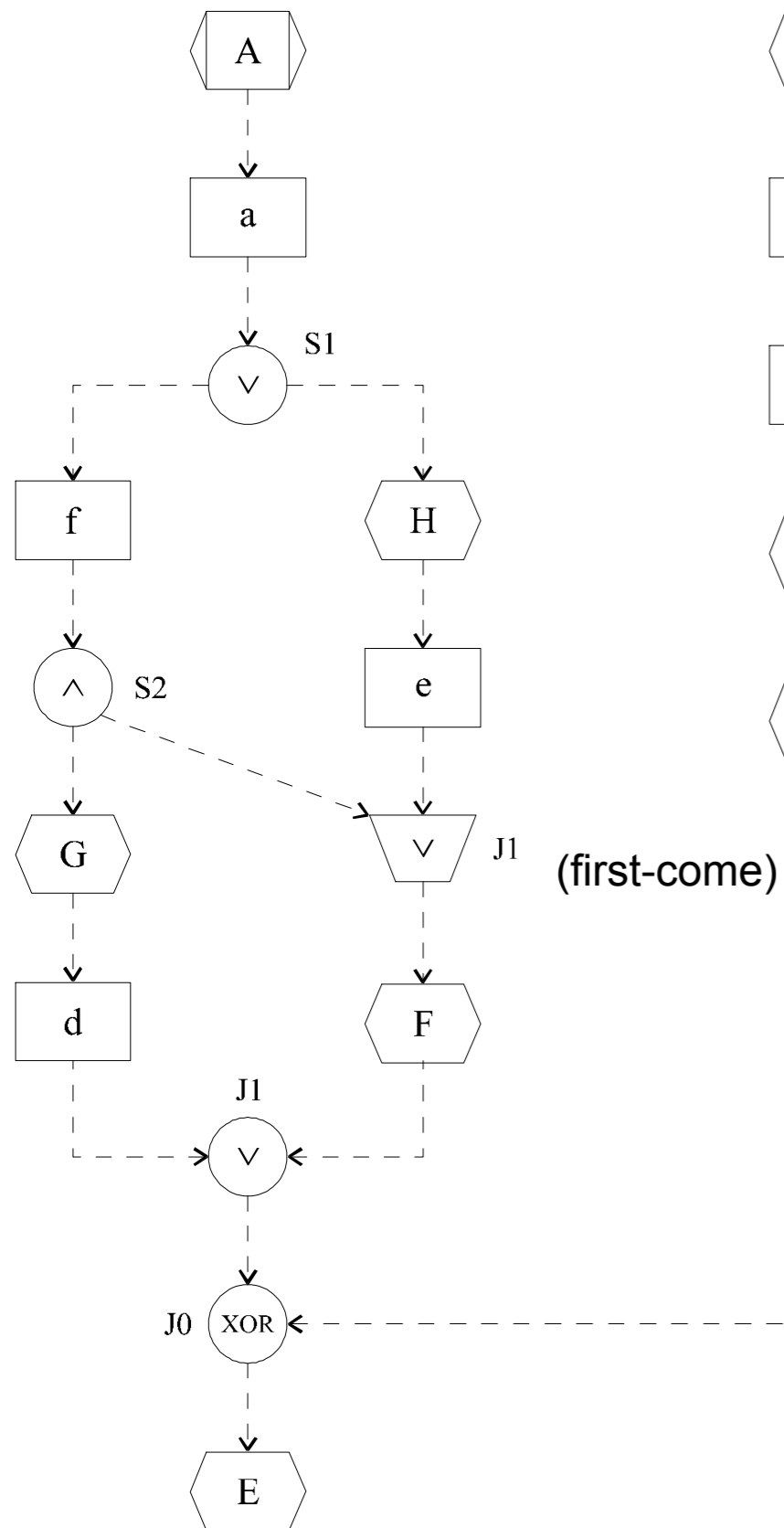

ZOOM IN

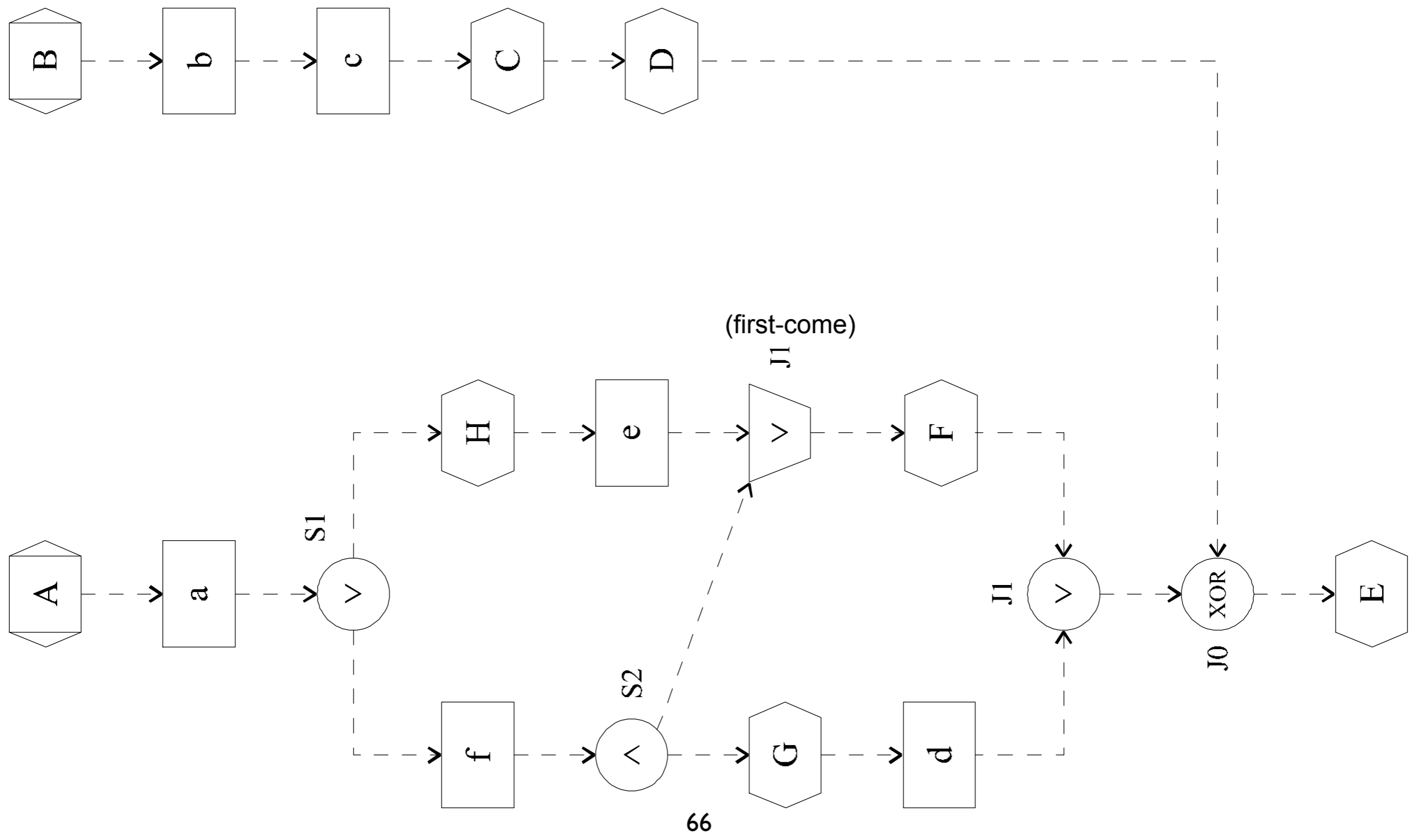

implicit XOR

matching split

Exercise

Sound?

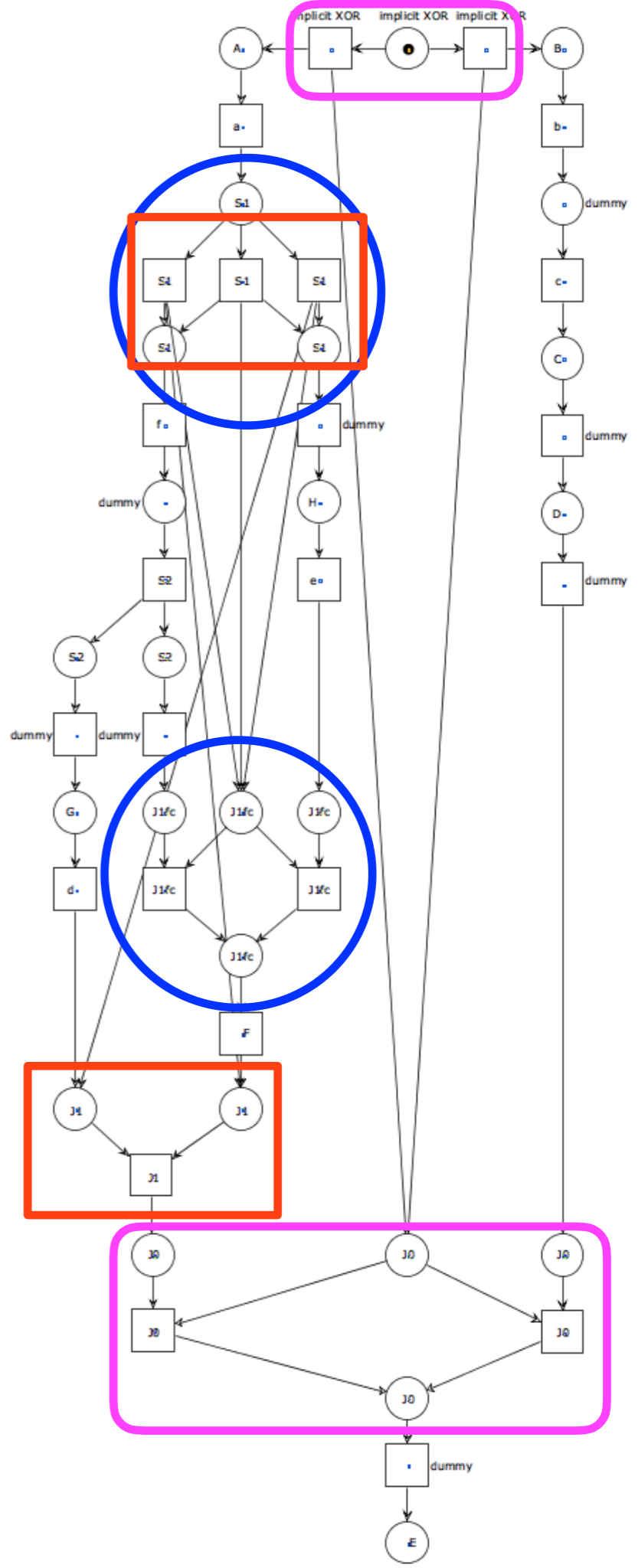
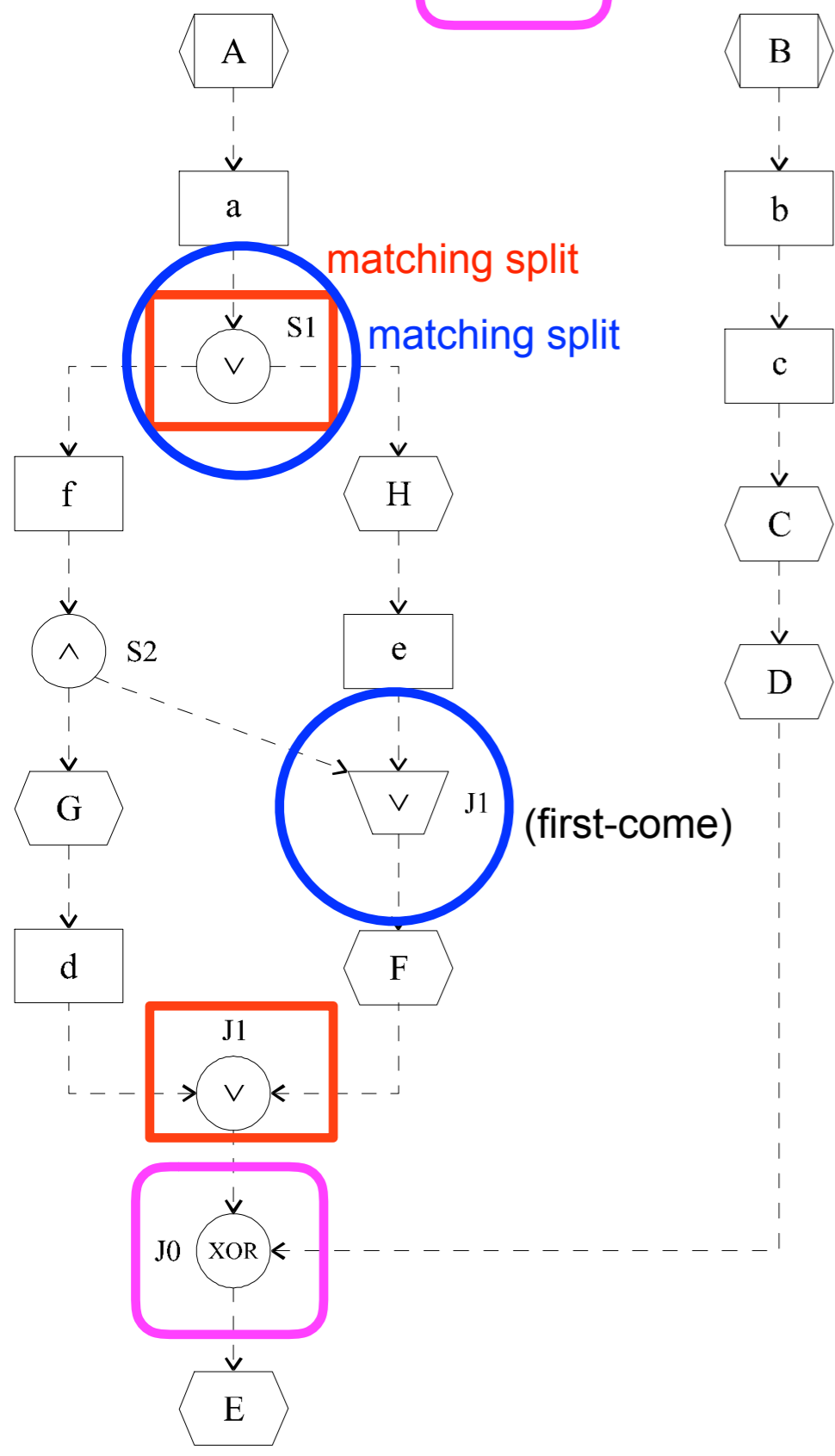

ZOOM IN

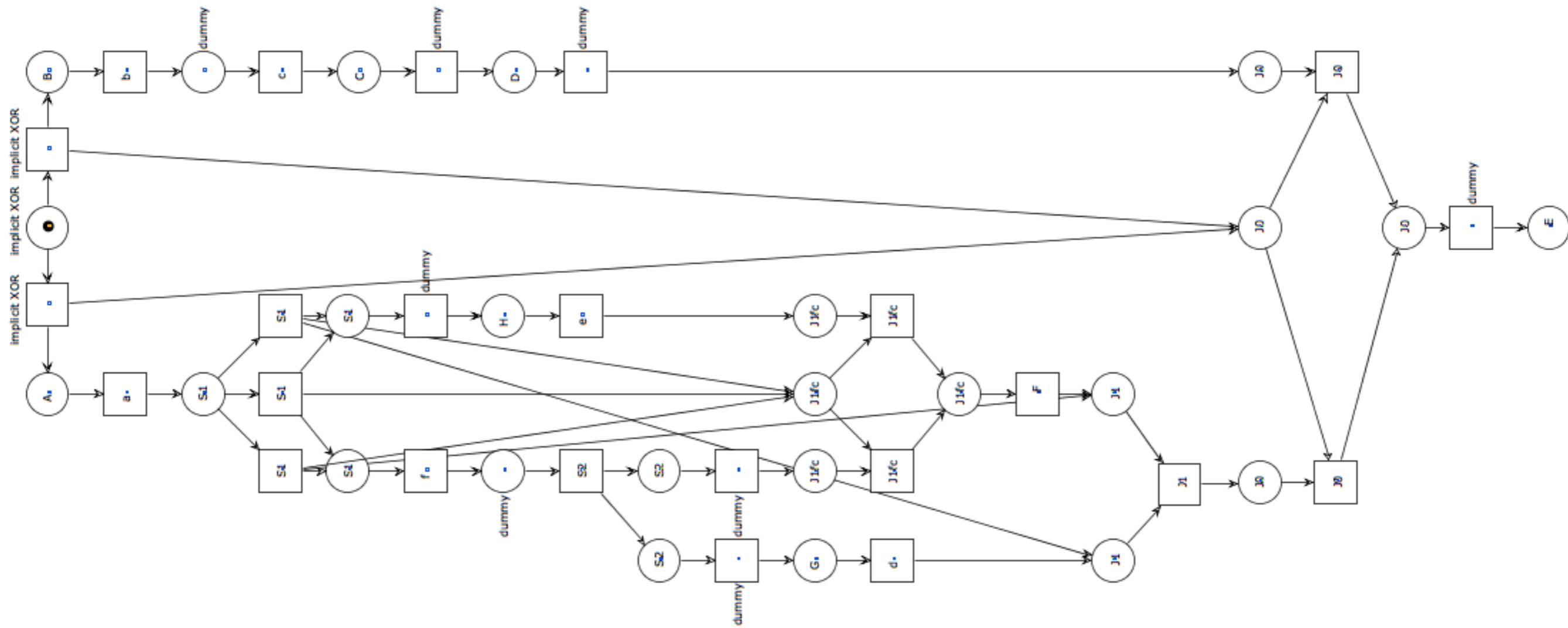

Exercise

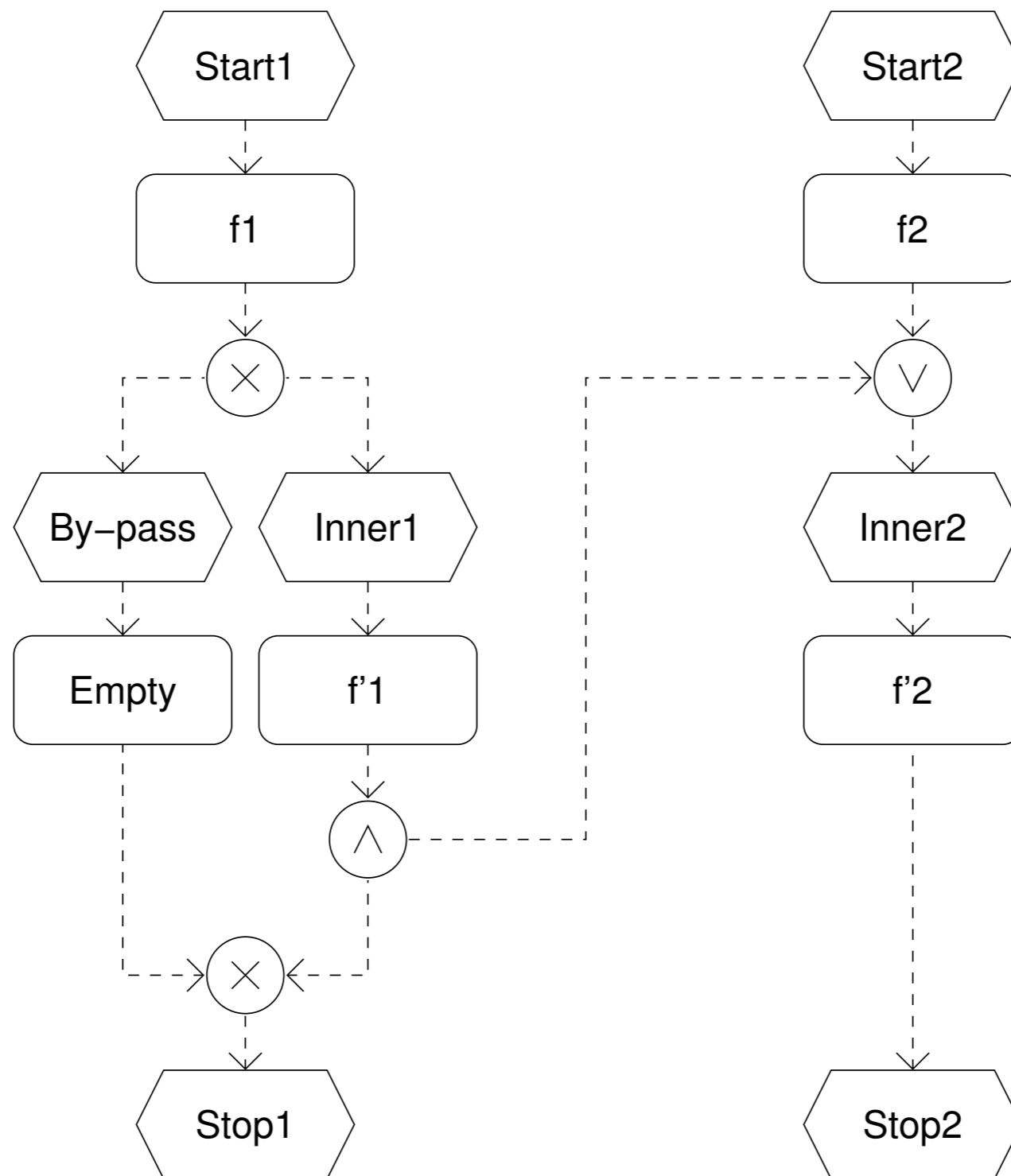

Sound?

Summary of problems

We need to decorate the EPC diagram
join decorated with matching/corresponding splits
OR-join decorated with policies

Split / join mismatch may induce unexpected behaviour

Possible introduction of dummy places and transitions

Second attempt
(no decoration available)

Simplified EPC

We rely on event / function alternation
along paths in the diagram
and also **along paths between two connectors**

OR-connectors are not considered

EPC 2 Petri nets: events and functions



event

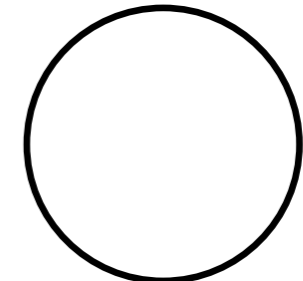
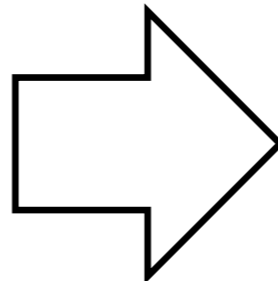

place



function

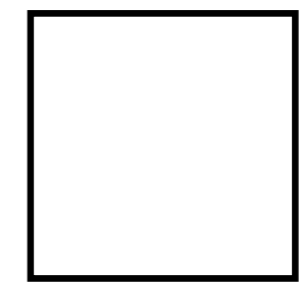
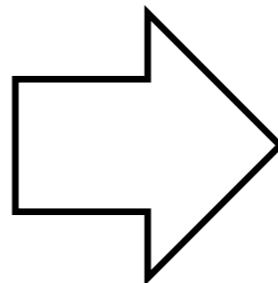

transition

EPC 2 Petri nets: split/join connectors

The translation of logical connectors
depends on the context:

if a connector connects **functions to events**
we apply a certain translation

if it connects **events to functions**
we apply a different translation

EPC 2 Petri nets: AND split

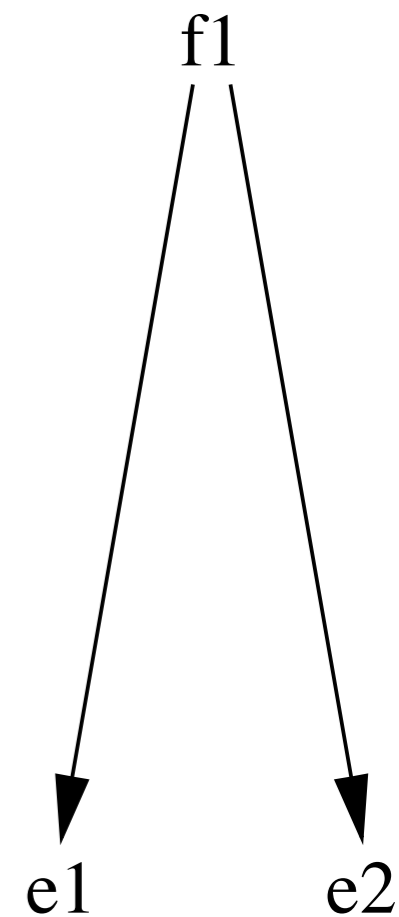
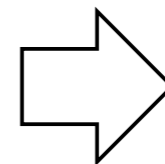
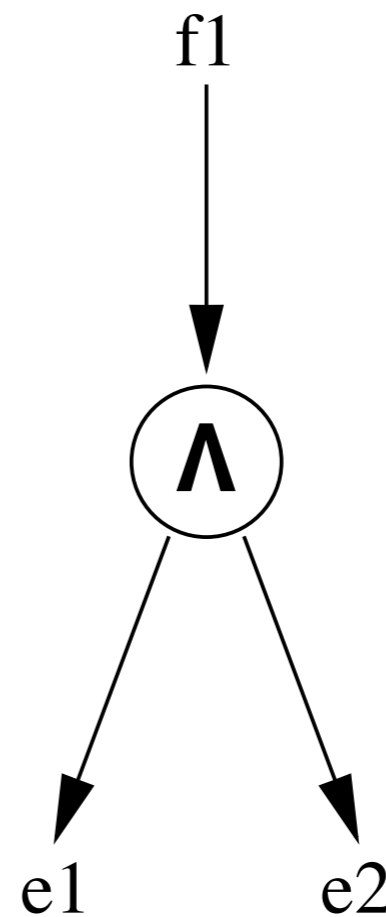
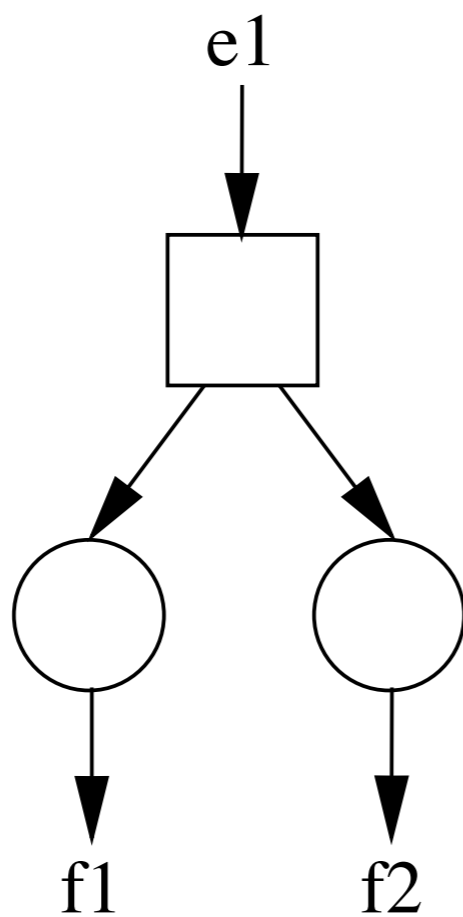
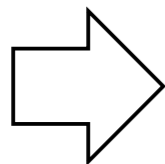
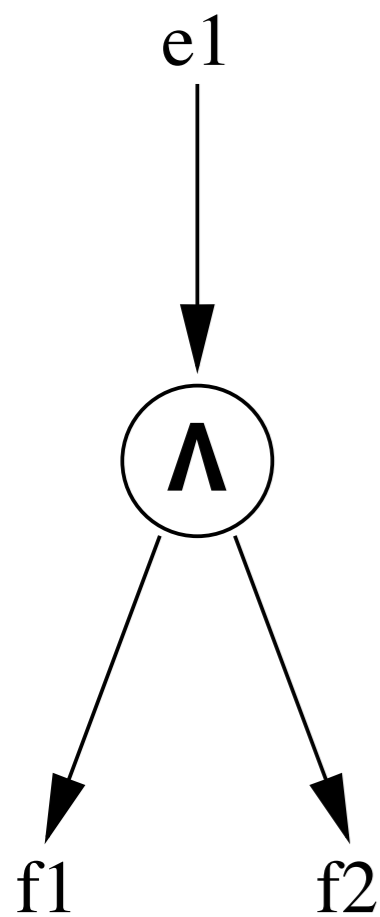

(event to functions)

(function to events)

EPC 2 Petri nets: AND-join

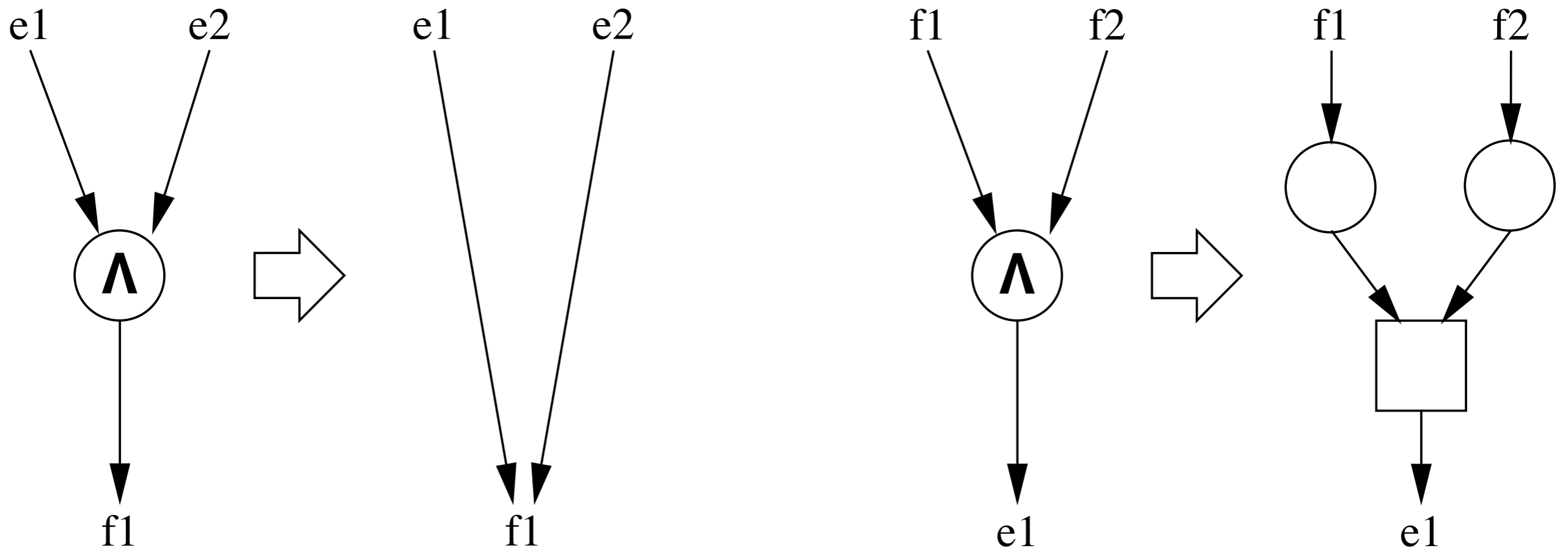

(events to function)

(functions to event)

EPC 2 Petri nets: XOR split

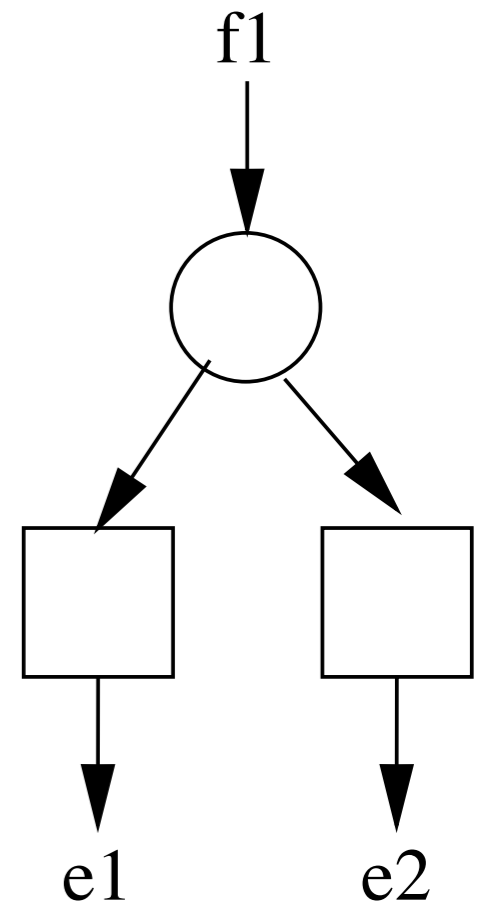
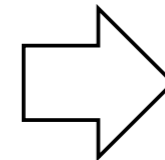
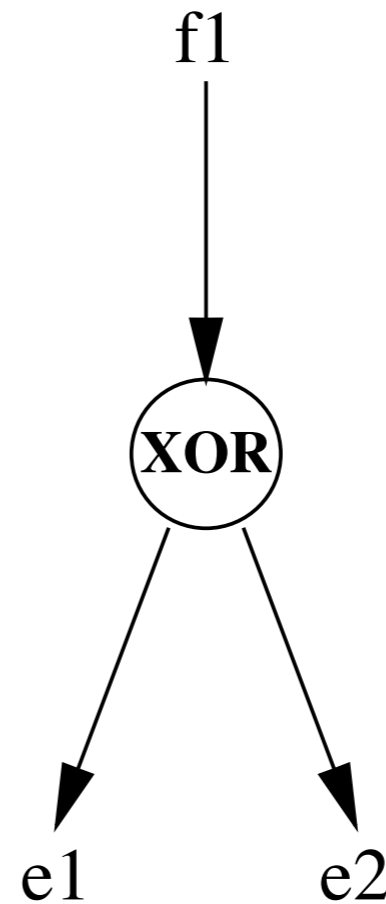
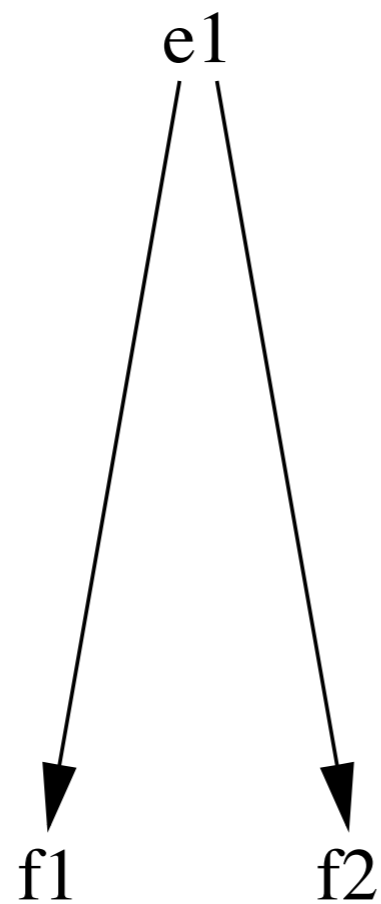
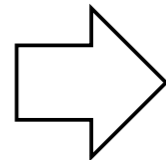
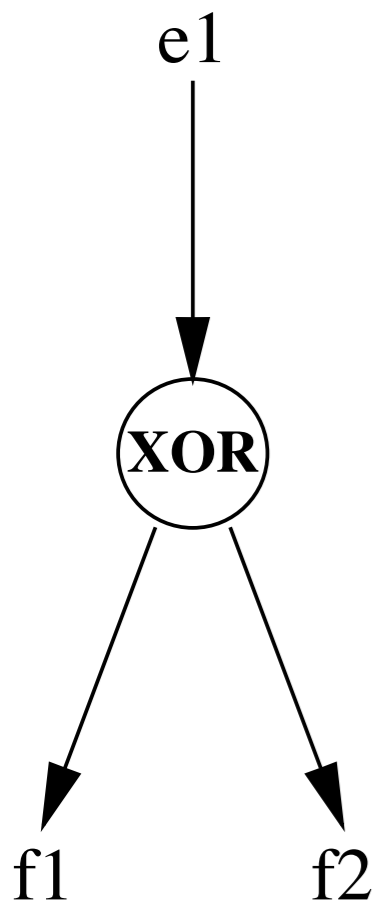

(event to functions)

(function to events)

EPC 2 Petri nets: XOR join

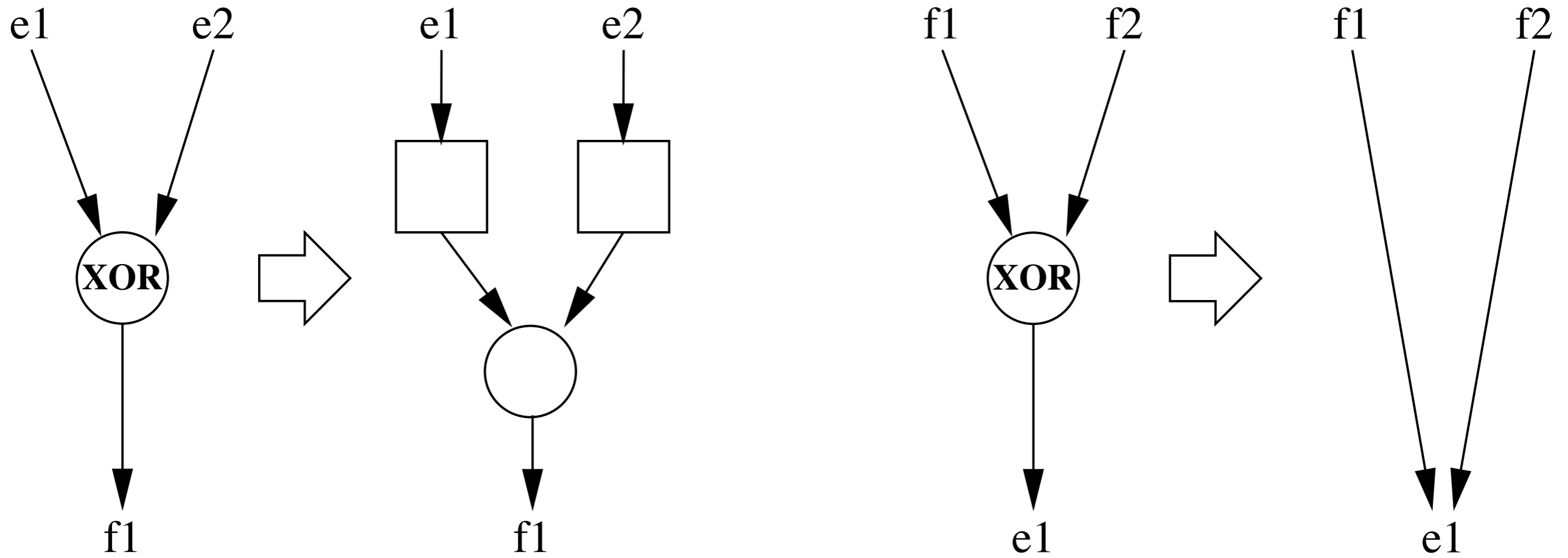

(events to function)

(functions to event)

EPC 2 Petri nets: at a glance

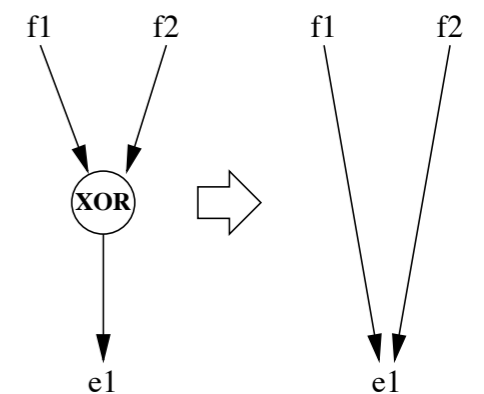
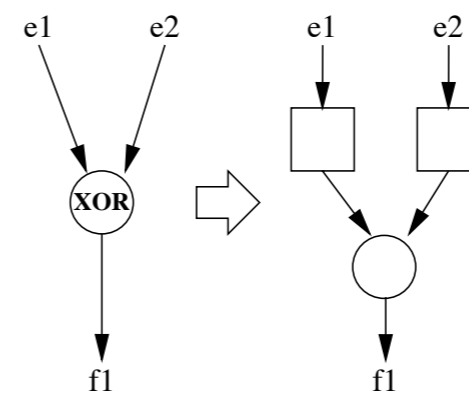
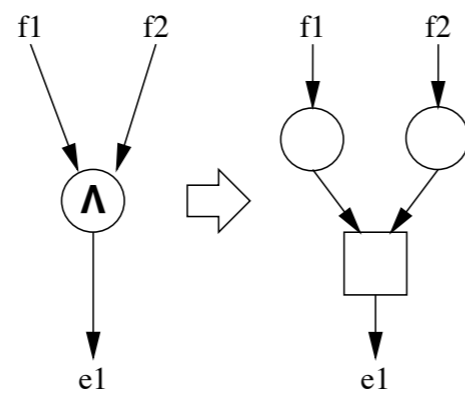
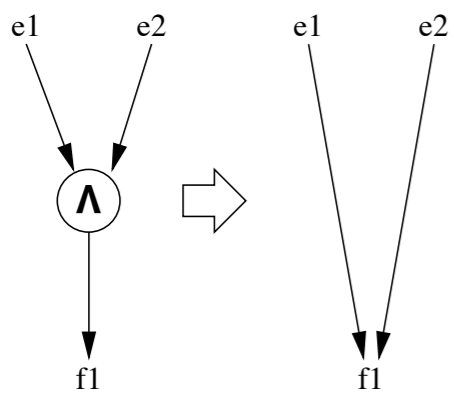
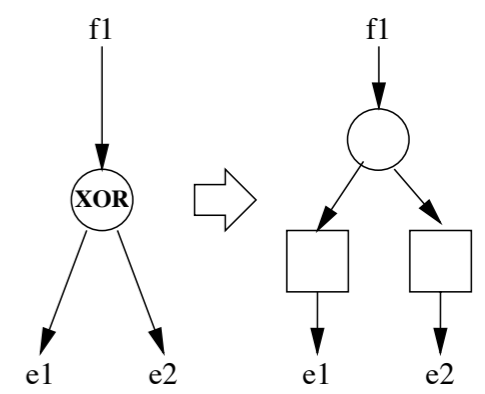
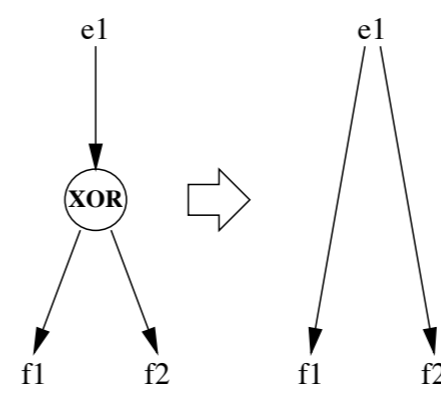
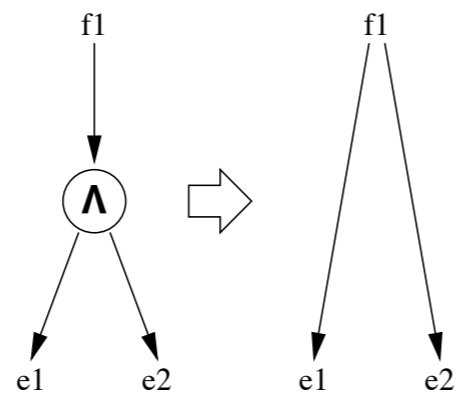
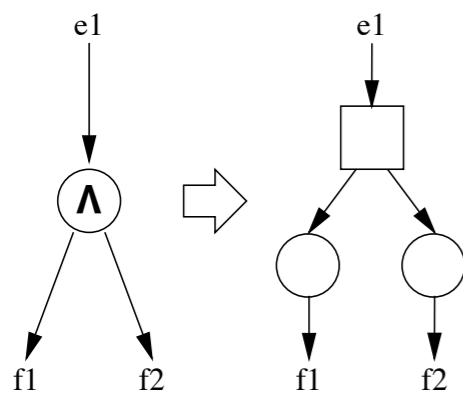
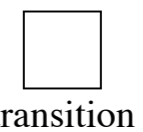
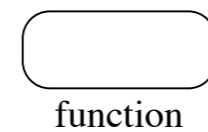
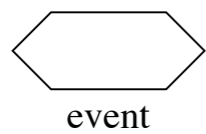

EPC 2 nets: Example

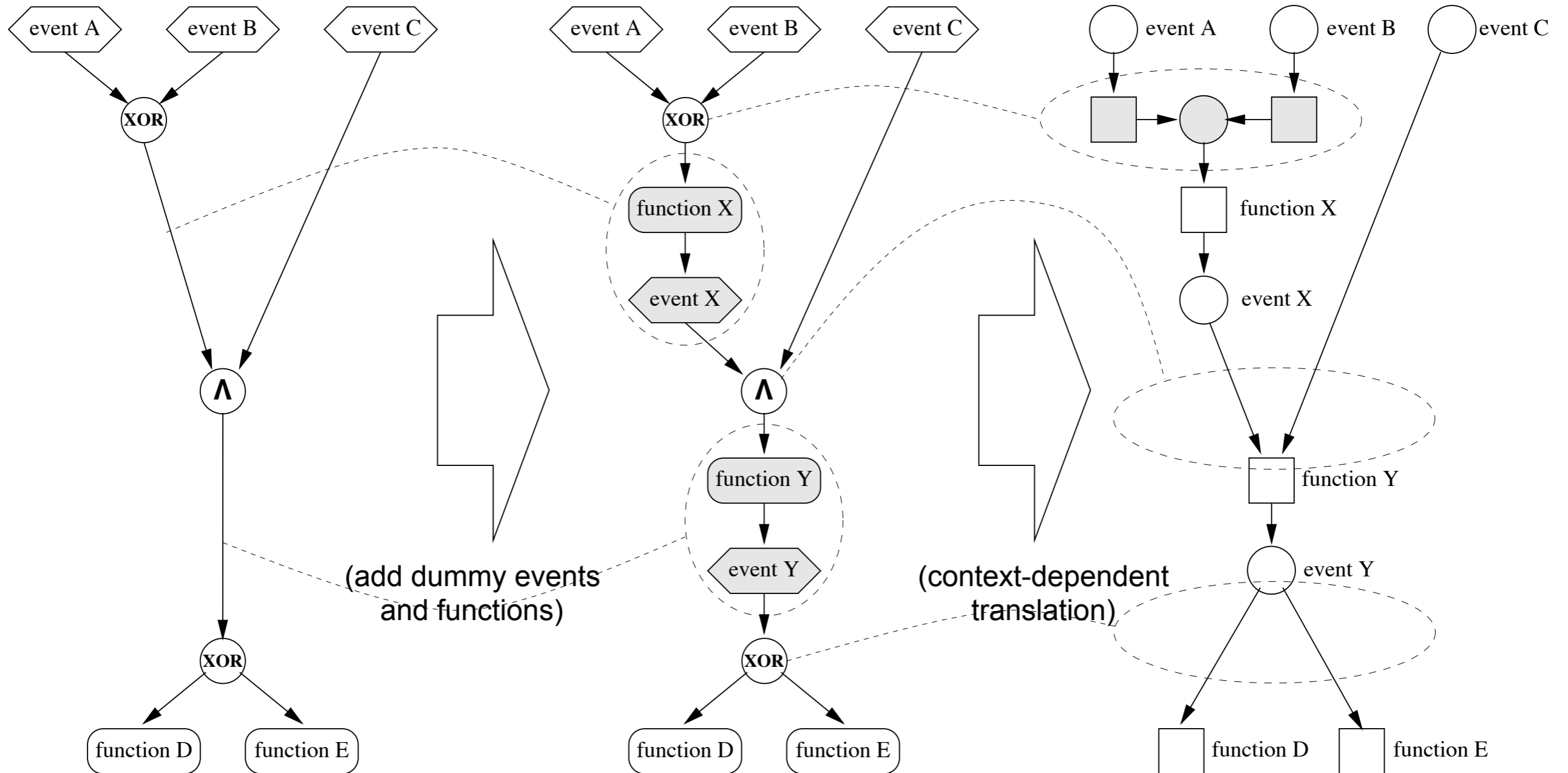

Outcome

From any EPC we derive a free-choice net

Moreover, if we add unique start / end events
(and suitable transitions attached to them)

the net is a workflow net

Exercise

Check it sound!

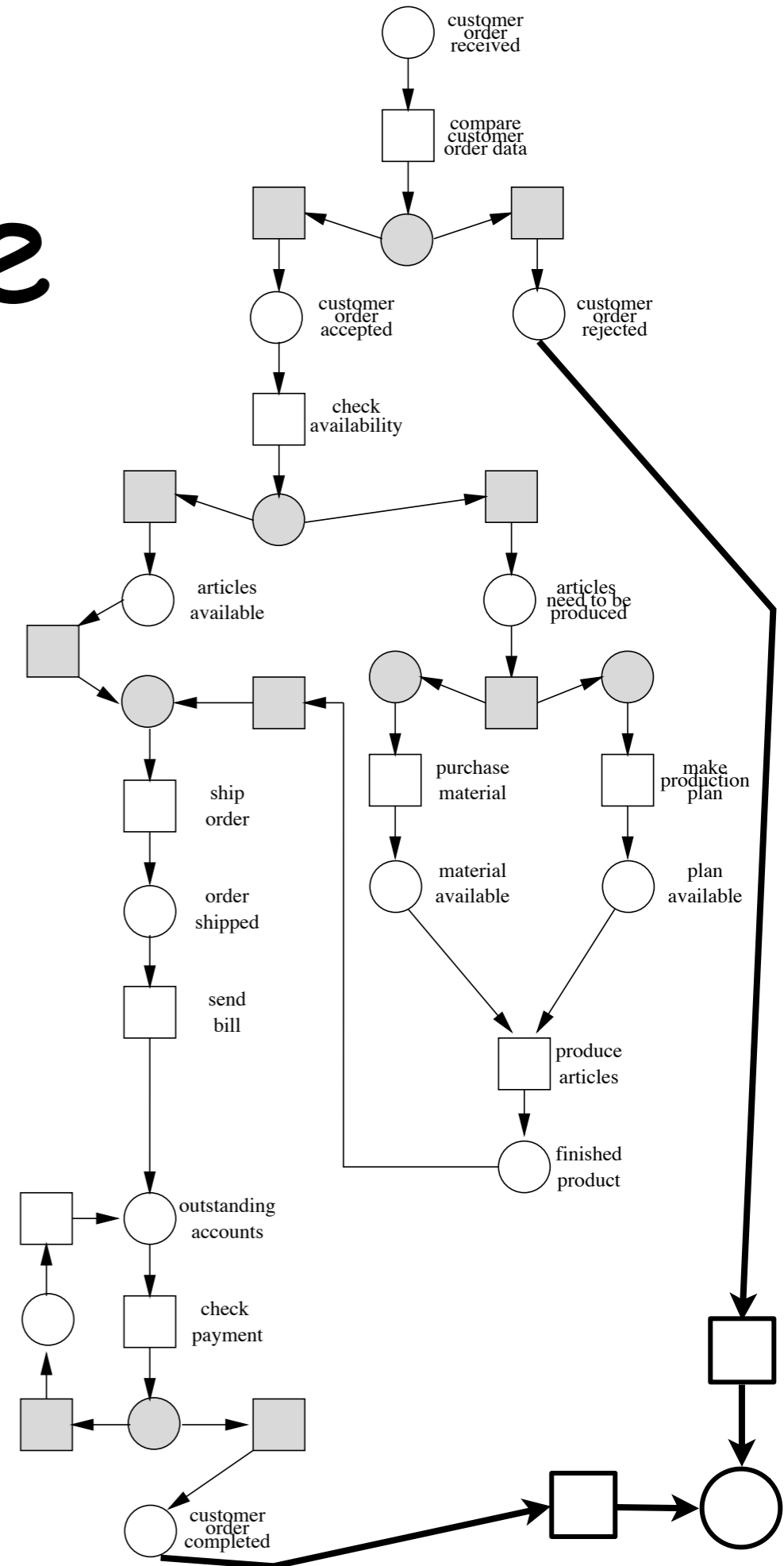
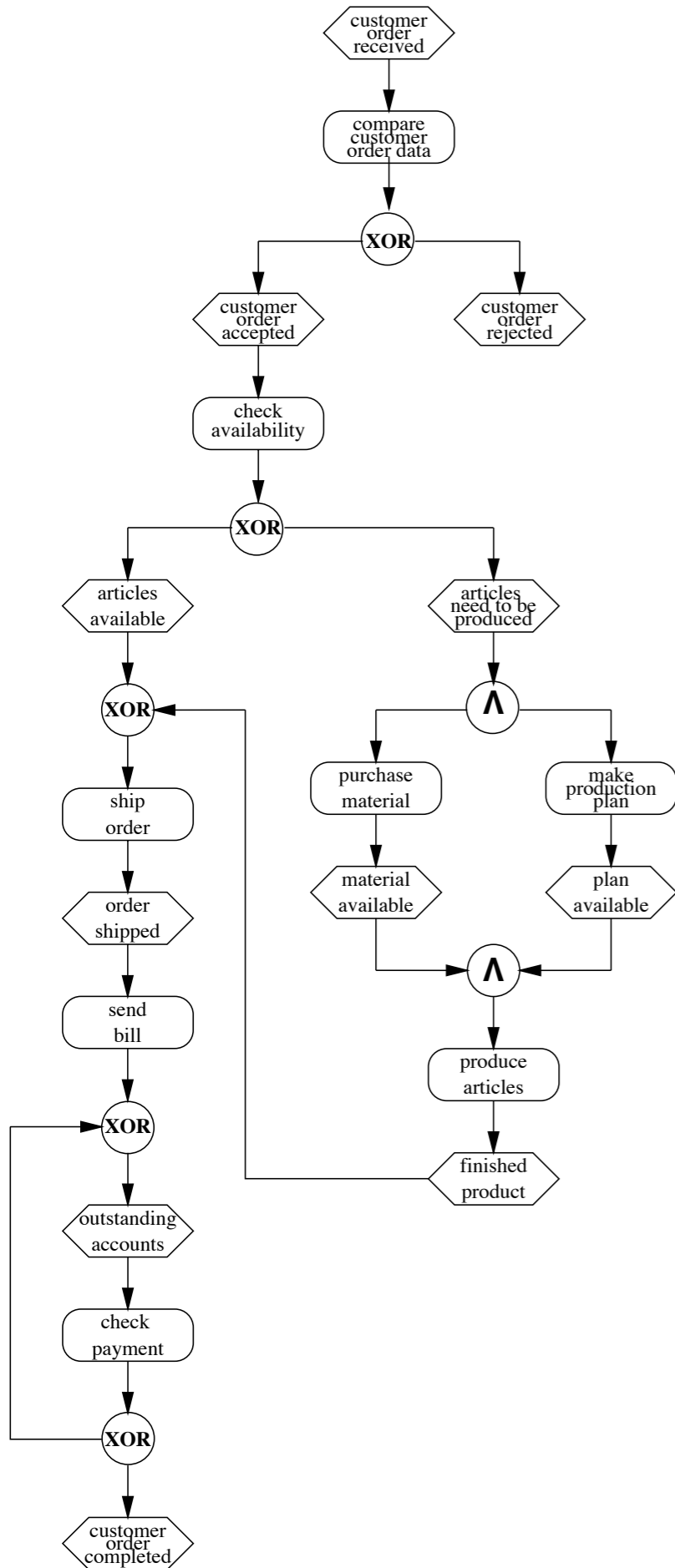

Exercise

Sound?

(remind
to add **dummy events and functions**
and
to guarantee **event/function alternation**)

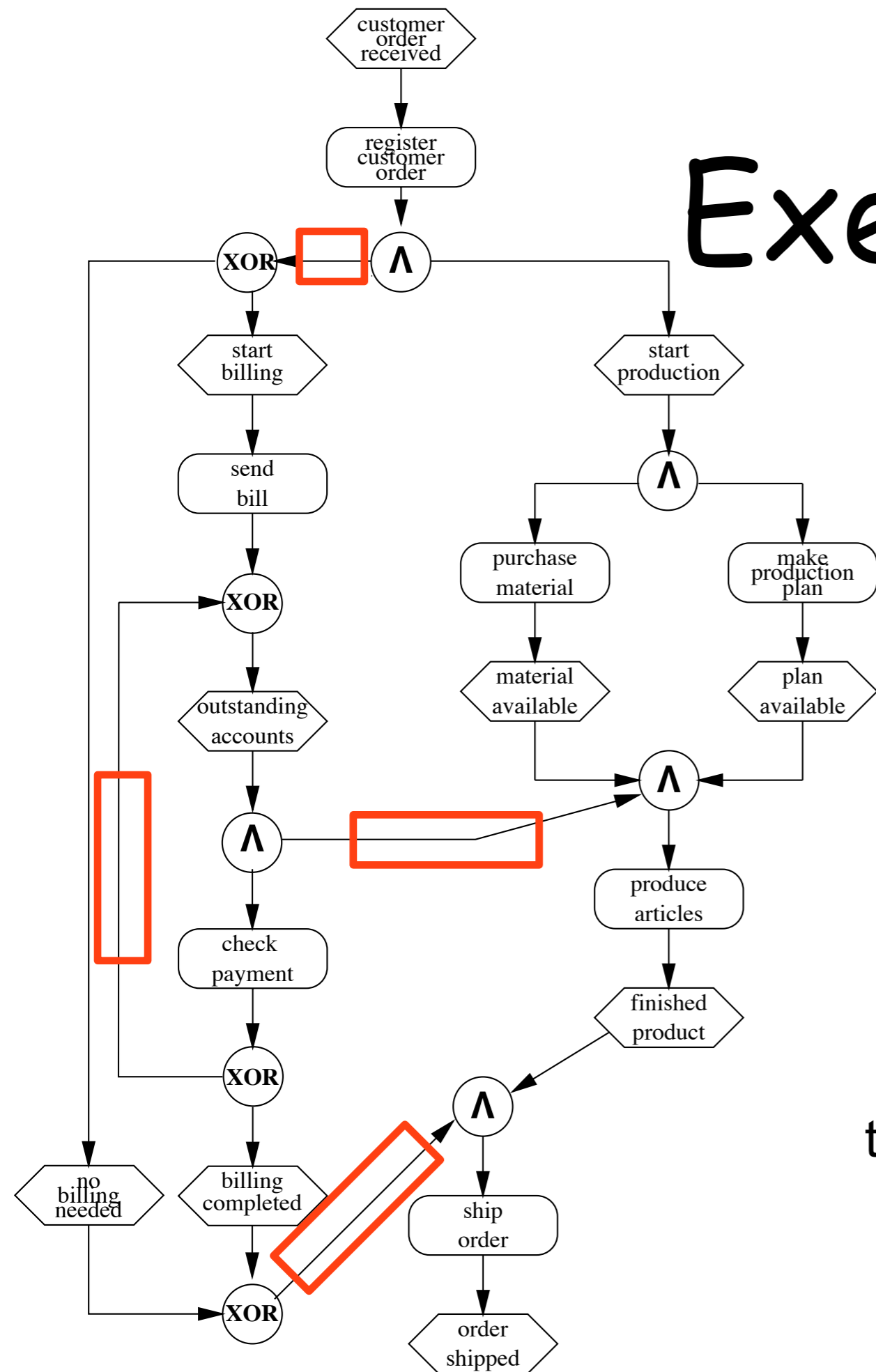

Relaxed soundness
(a third attempt)

Popularity vs superiority

EPC are a quite successful, semiformal notation

They lack a comprehensive and consistent syntax
They lack even more a corresponding semantics

You may **restrict the notation**, but people will prefer the more liberal (flexible) syntax and ignore the guidelines

You may **enrich the notation**, but people will dislike or misinterpret implementation policies

What are ultimately business process?

Graphical language to **communicate** concepts

Careful selection of symbols
shapes, colors, arrows

(the alphabet is necessary for communication)

Greatest common denominator of the people involved

Intuitive meaning

(verbal description, no math involved)

Remember some good old friends



Chief Process Officer

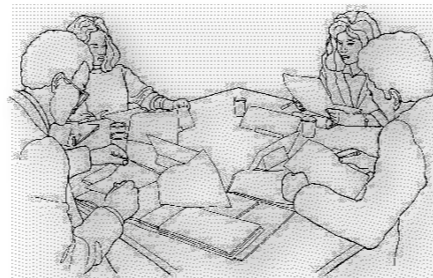

System architect



EPC

Process participants

Business engineer



Process responsible

WFnet



System developer



Process designer



Knowledge worker

A secret not to tell

Ambiguity is useful in practice!

The more ways are to interpret a certain construct
the more likely an agreement will be reached

A pragmatic consideration

Moreover

in the **analysis phase**
the participants may not be ready
to **finalise** the specification
and decide for the **correct interpretation**

Yet

it is important to find out **flaws** as **soon** as possible

Consequences

Ambiguous process description can constitute
a **major problem** in the **design phase**

Therefore

we need to fix a **formal representation**
that **preserves all ambiguities**

Problem

EPC is fine (widely adopted)

WF nets offer a useful tool

but

Soundness is too demanding at early stages

Relaxed soundness

A **sound** behaviour:

we move from a start event to an end event
so that nothing blocks or remains undone

Execution paths leading to **unsound** behaviour
can be used to infer potential mistakes in the EPC

If some unsound behaviour is possible
but **enough** sound paths exist
the process is called **relaxed sound**

A 3-steps approach
(keep it simple!)

Step 1: straightforward element map

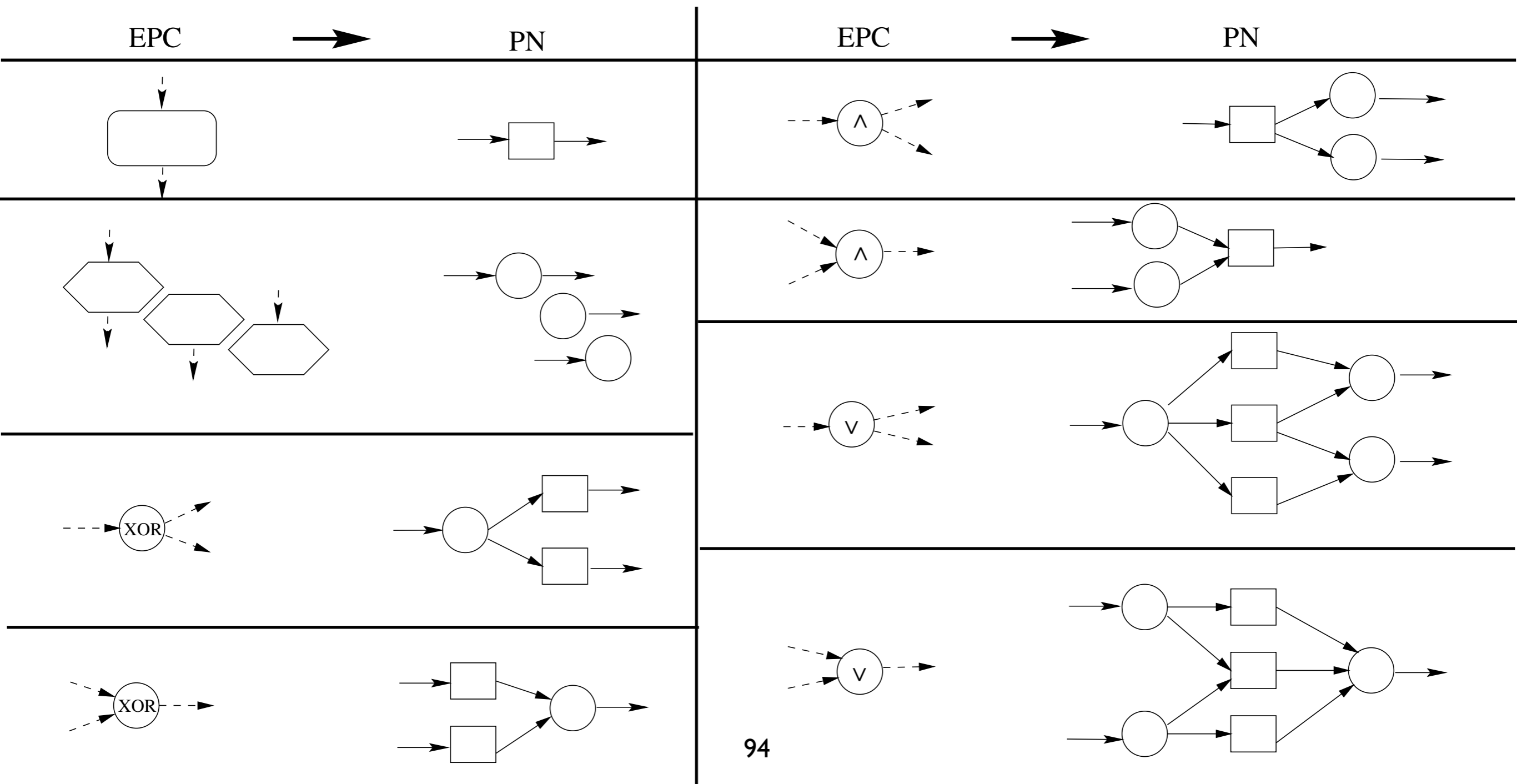

Step 2: element fusion

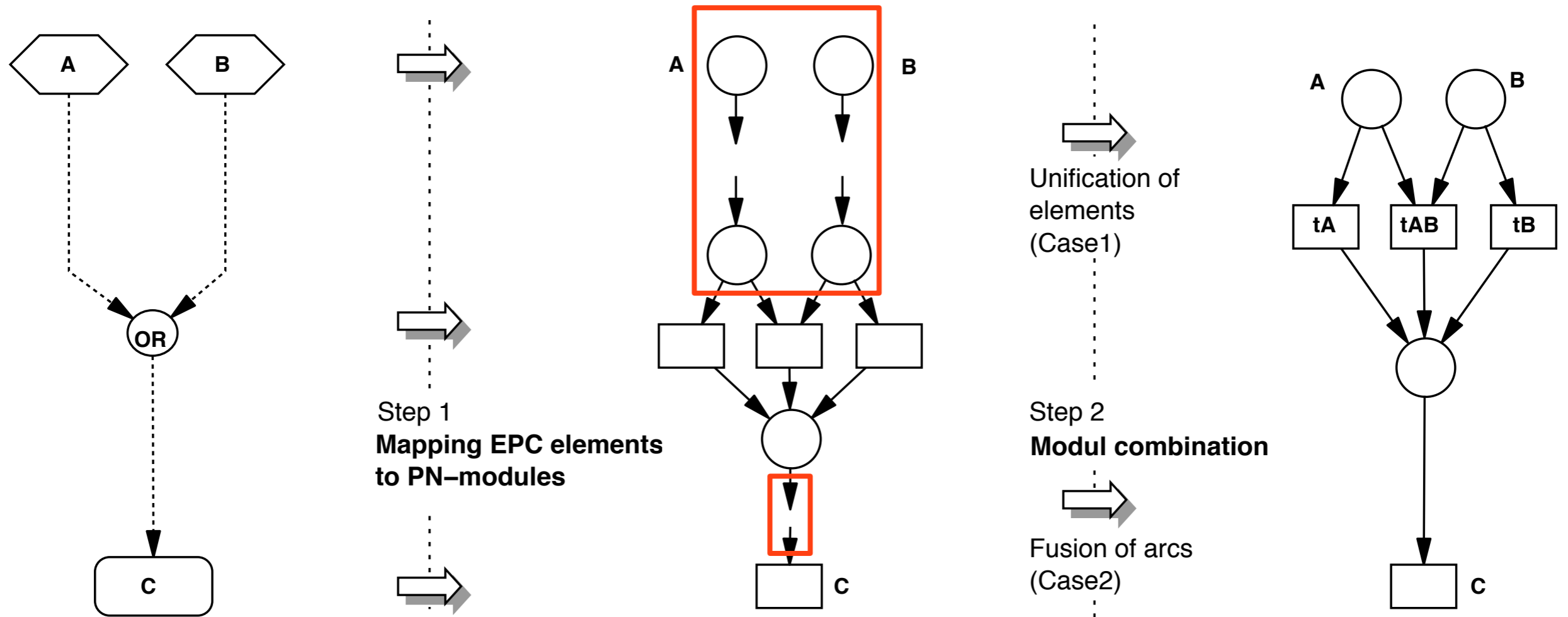

Step 3: add unique start / end

a)

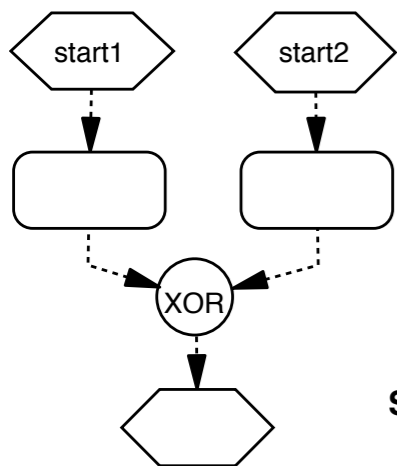

Step1 &
Step2

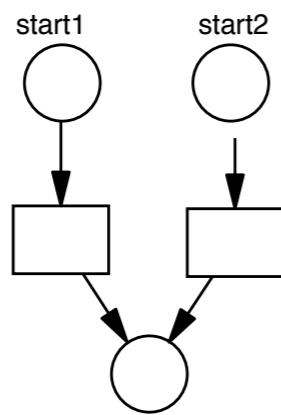
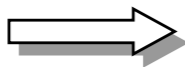

Step3

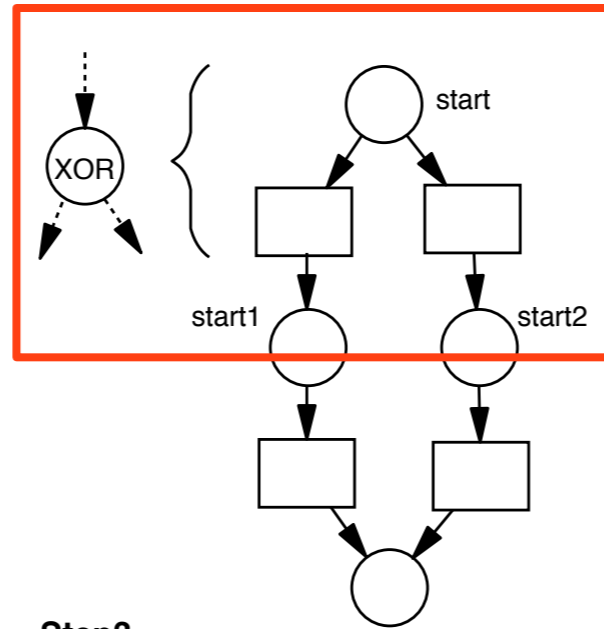
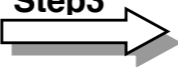

XOR start

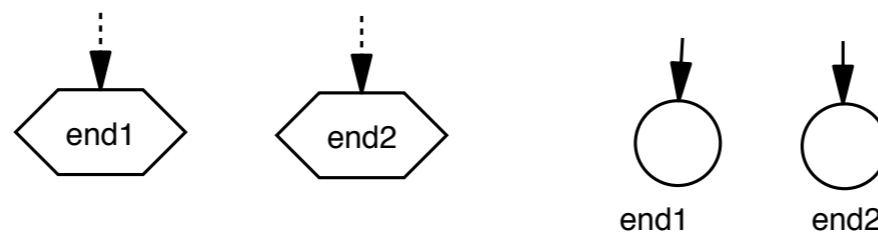

Step1 &
Step2

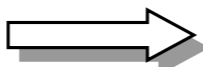

(sometimes XOR/AND can be preferred)

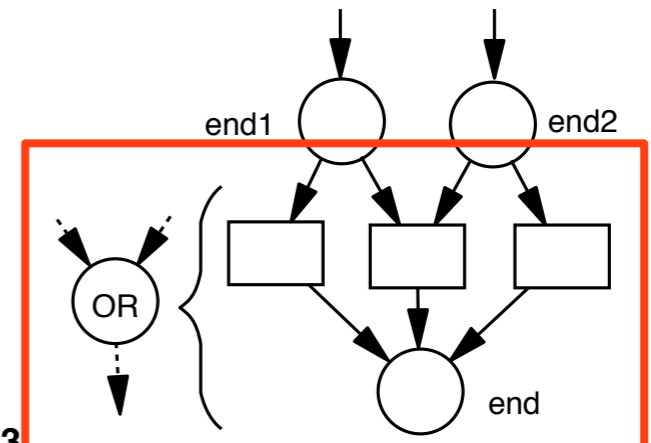

OR end

Example

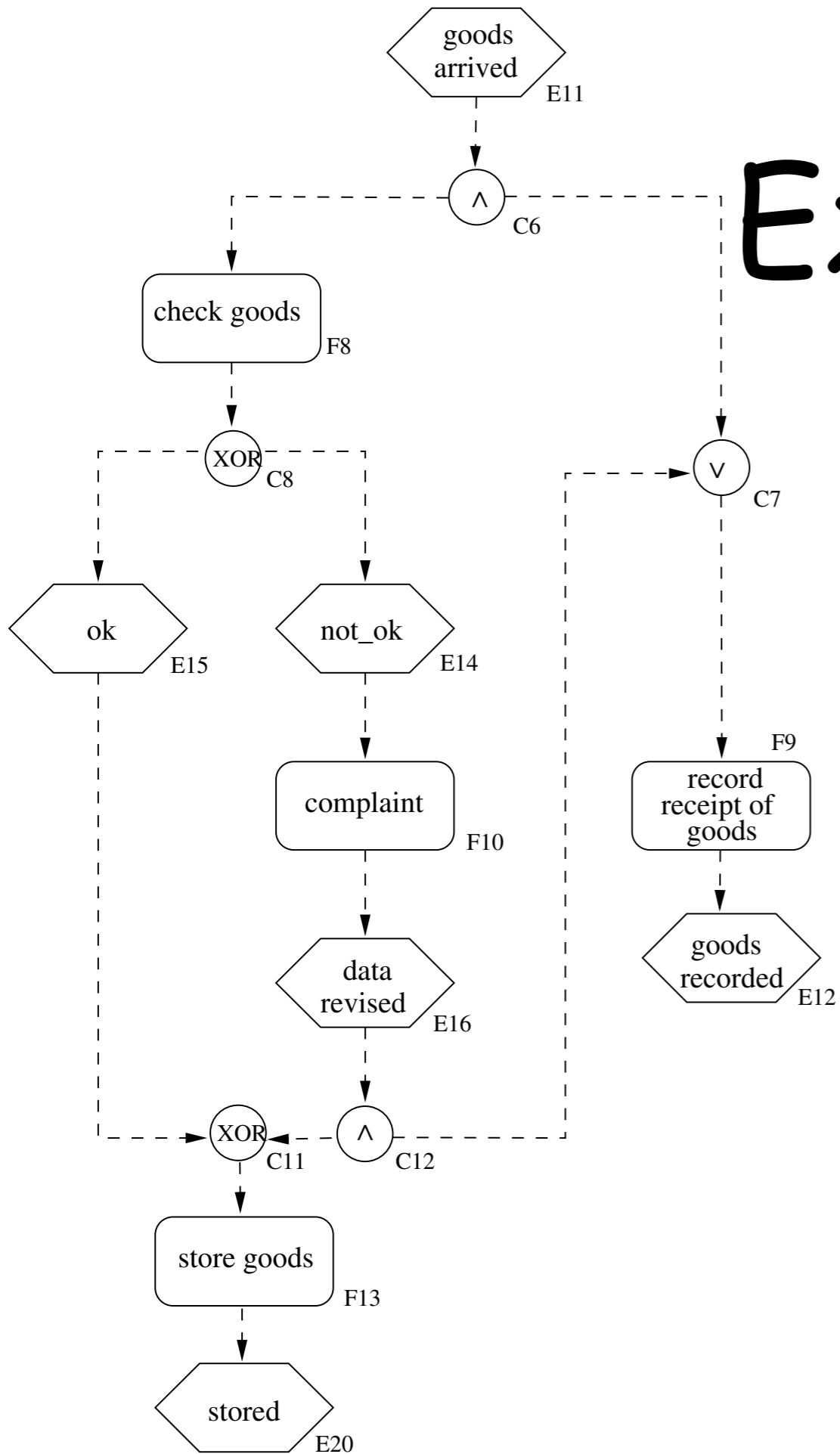

Sound?

Example

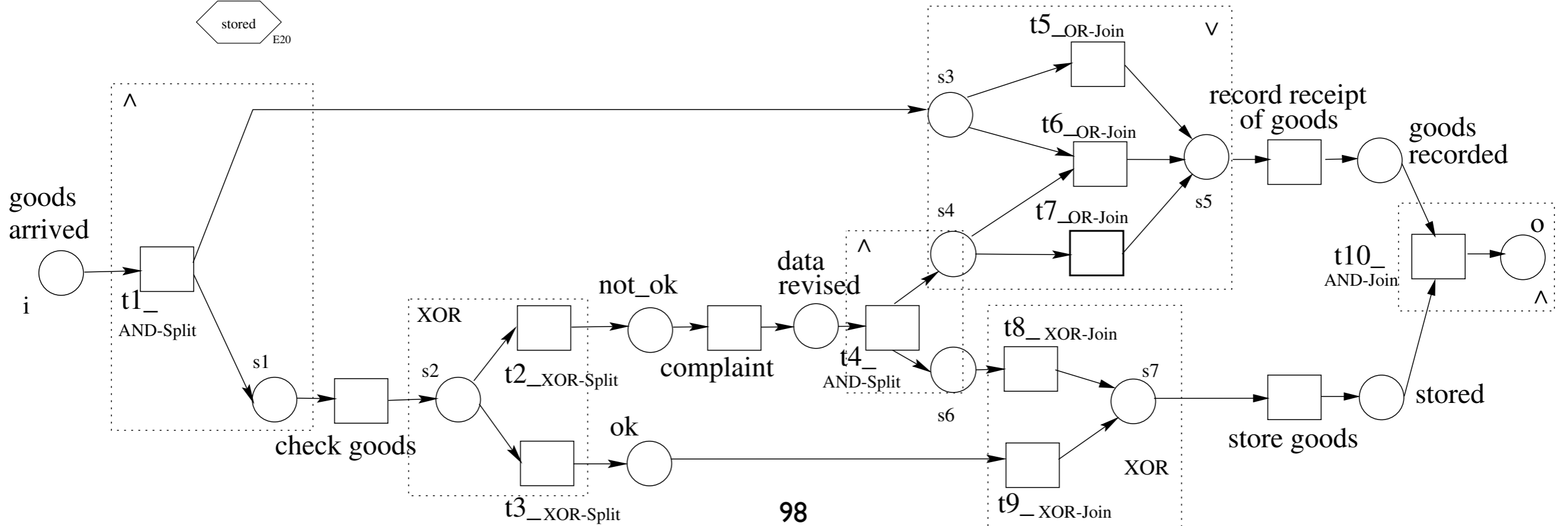
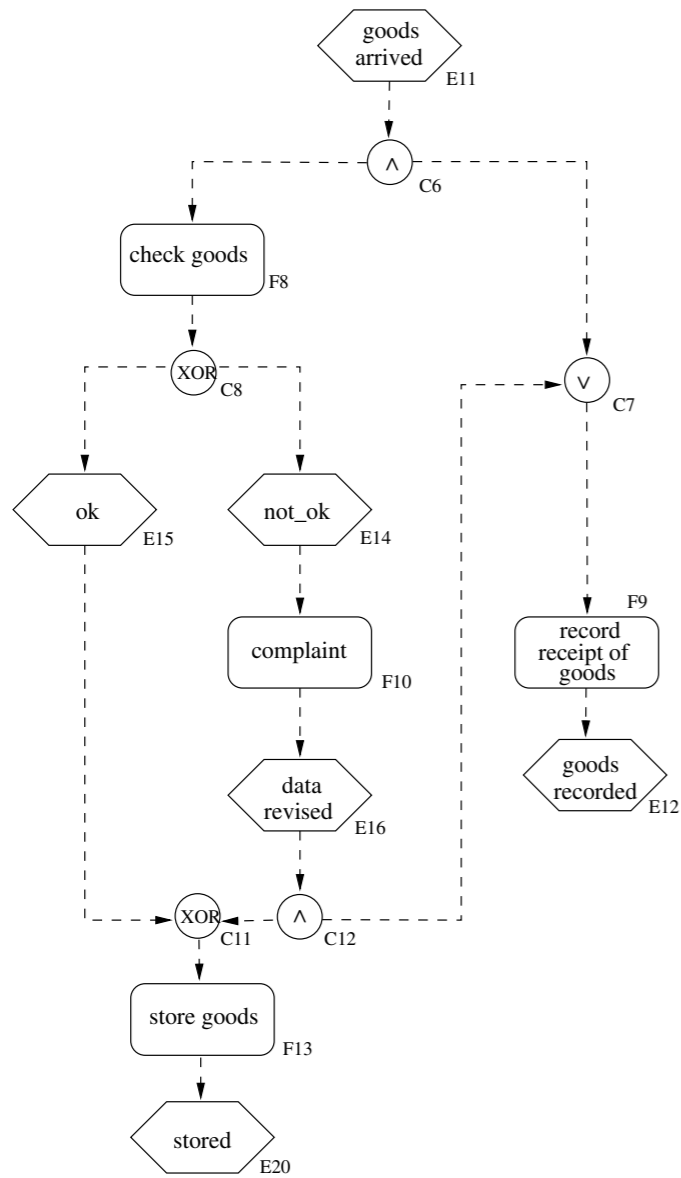

Example

Not sound!

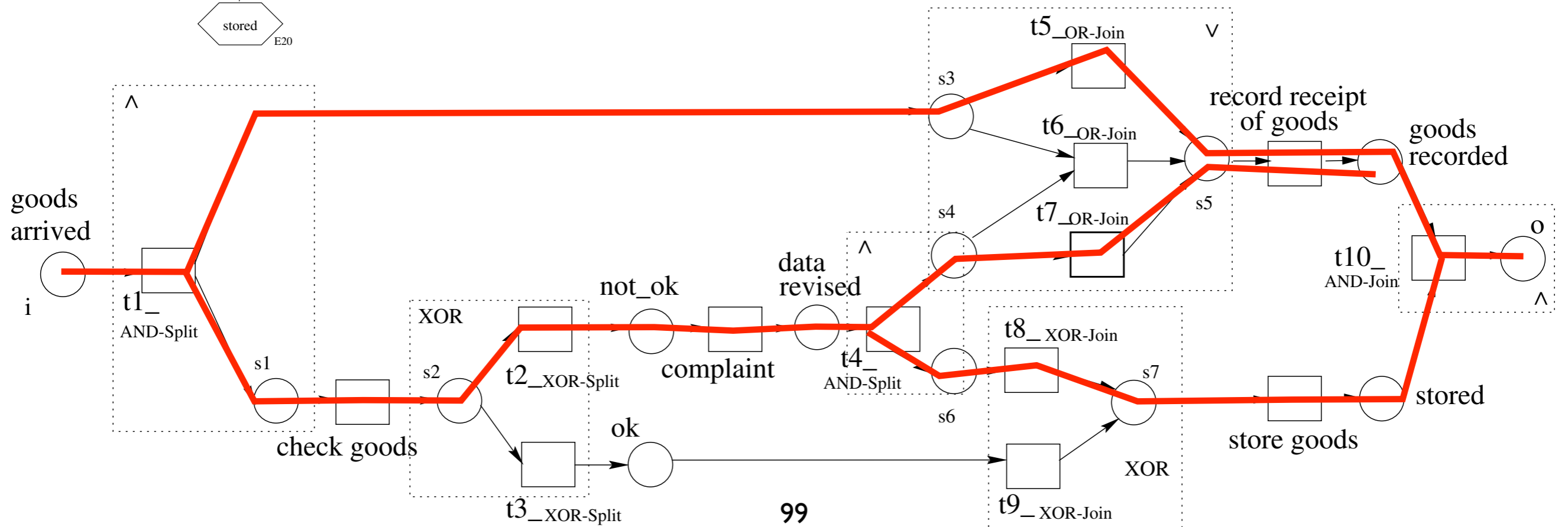
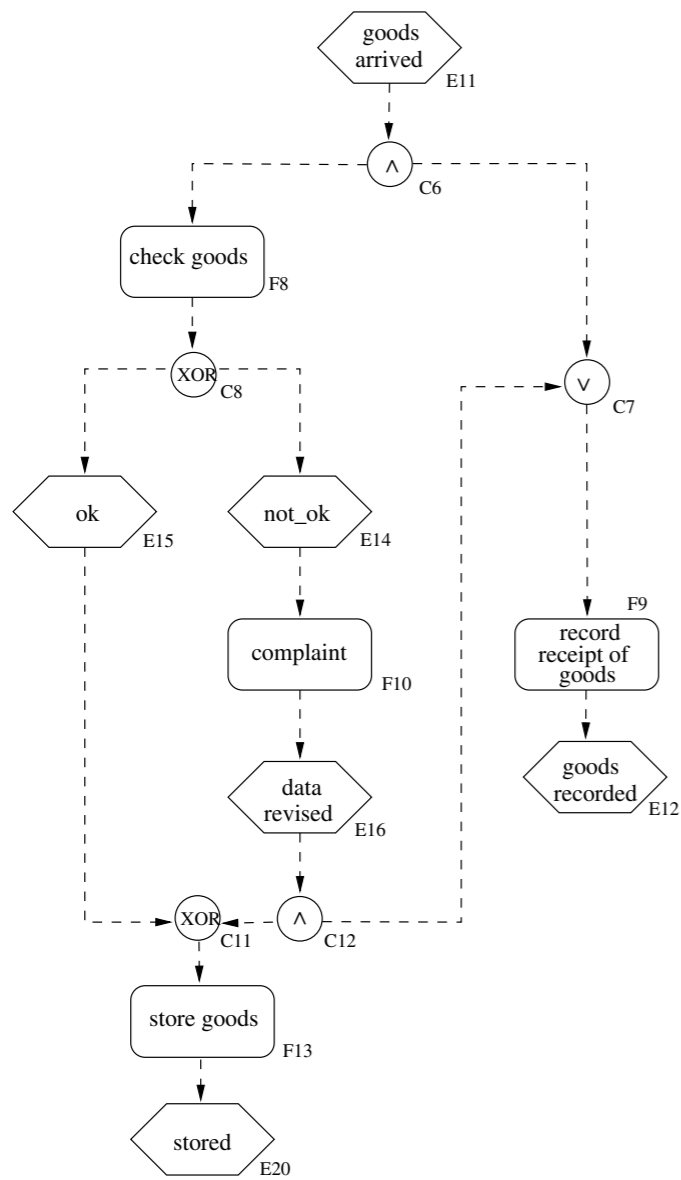

Example

We can turn it to sound, but:
small changes in the net, turn big in EPC

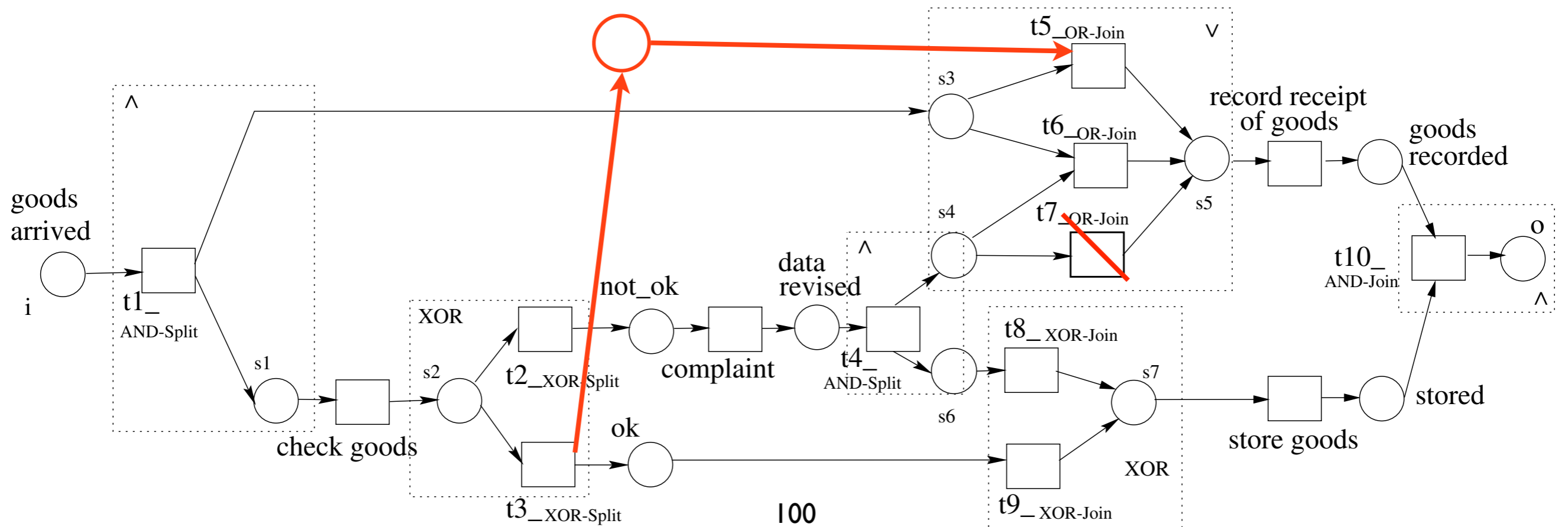

Relaxed soundness: formally

Definition: A WF net is **relaxed sound** if every transition belongs to a firing sequence that starts in state i and ends in state o

$$\forall t \in T. \exists M, M'. i \rightarrow^* M \xrightarrow{t} M' \rightarrow^* o$$

(it is sound “enough”, in the sense that all transitions are covered by at least one sound execution)

Example

Relaxed sound?

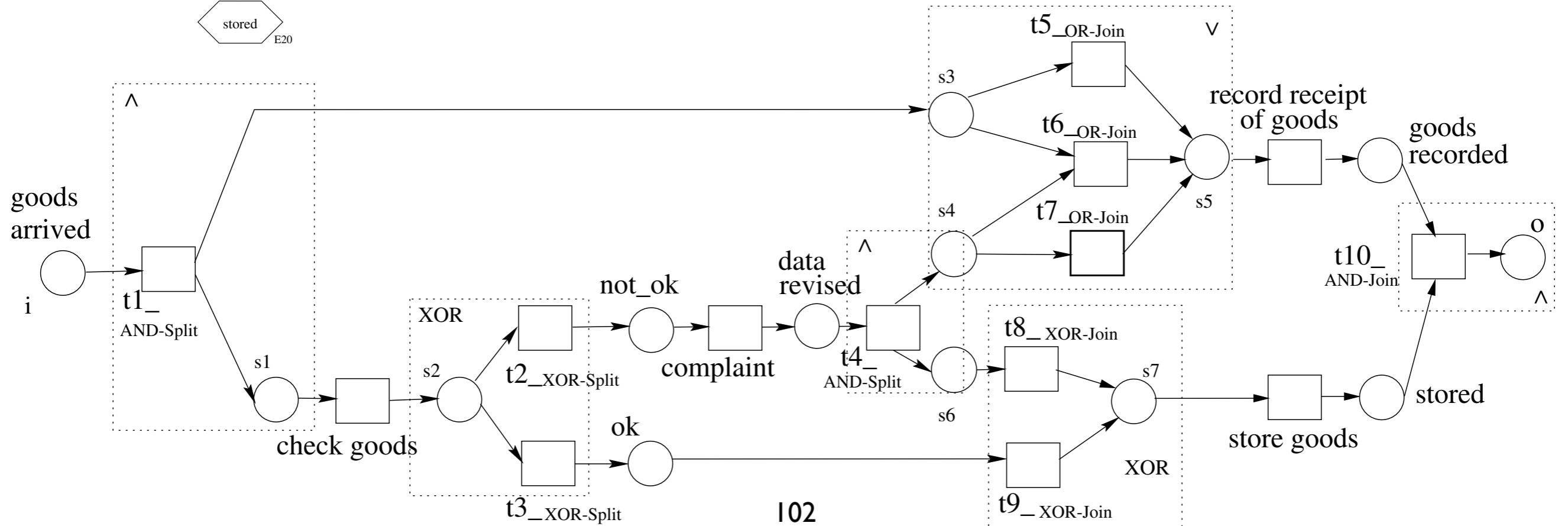
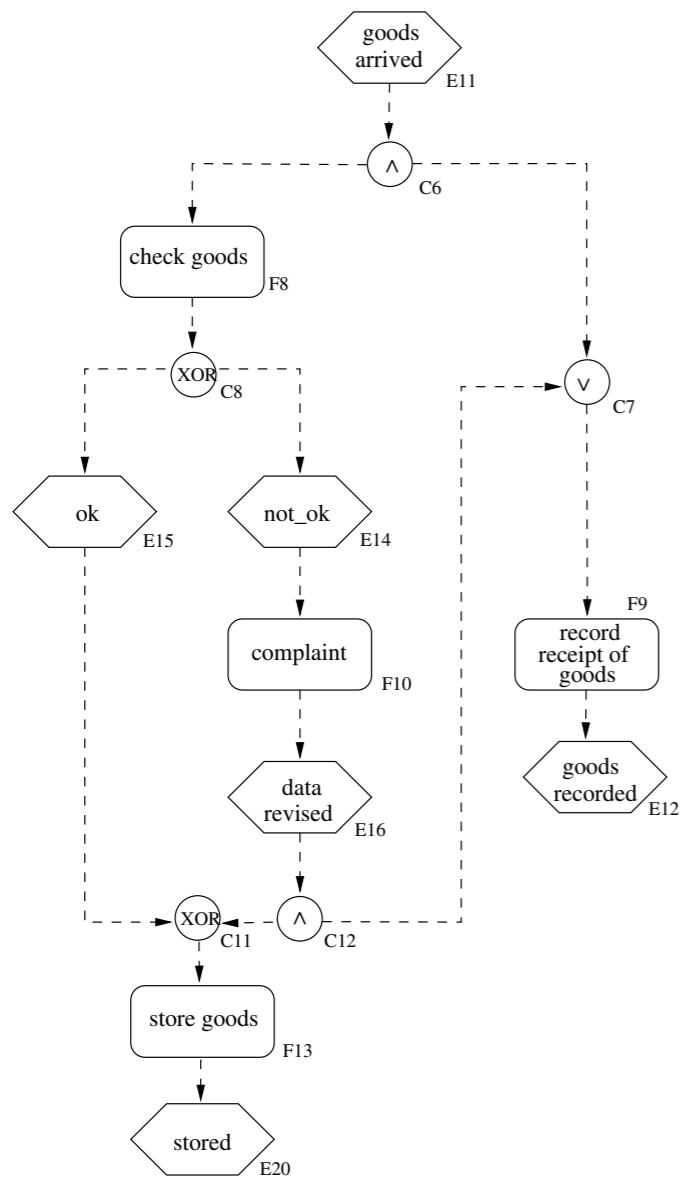

Example

Relaxed sound?

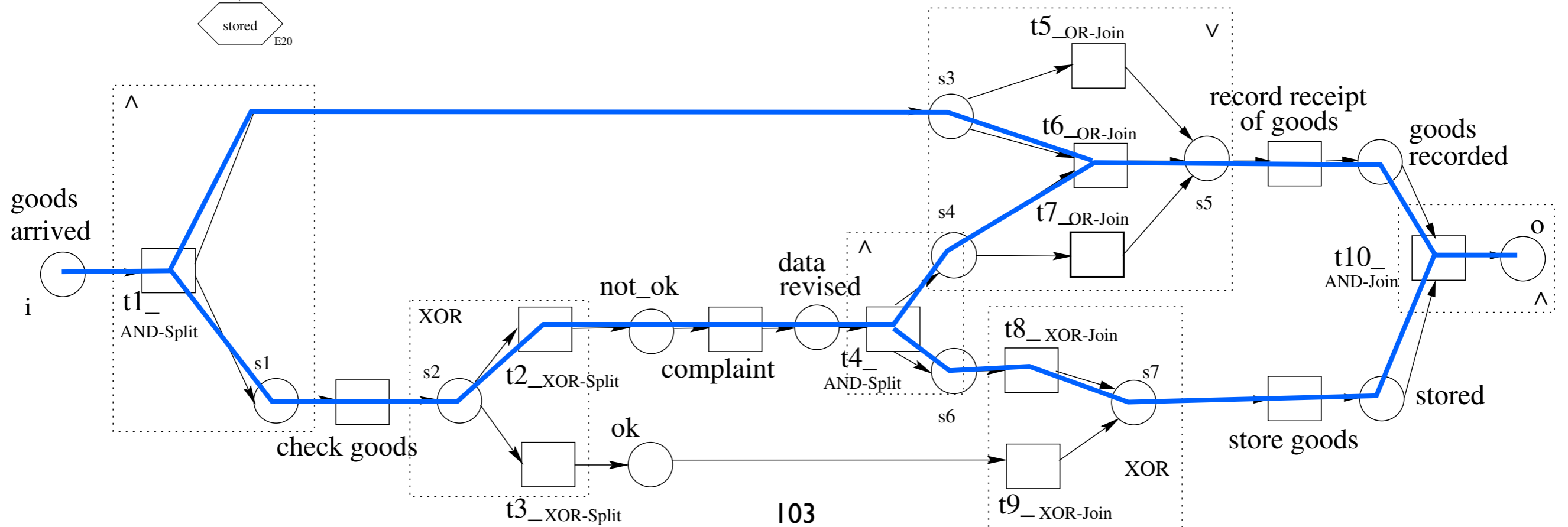
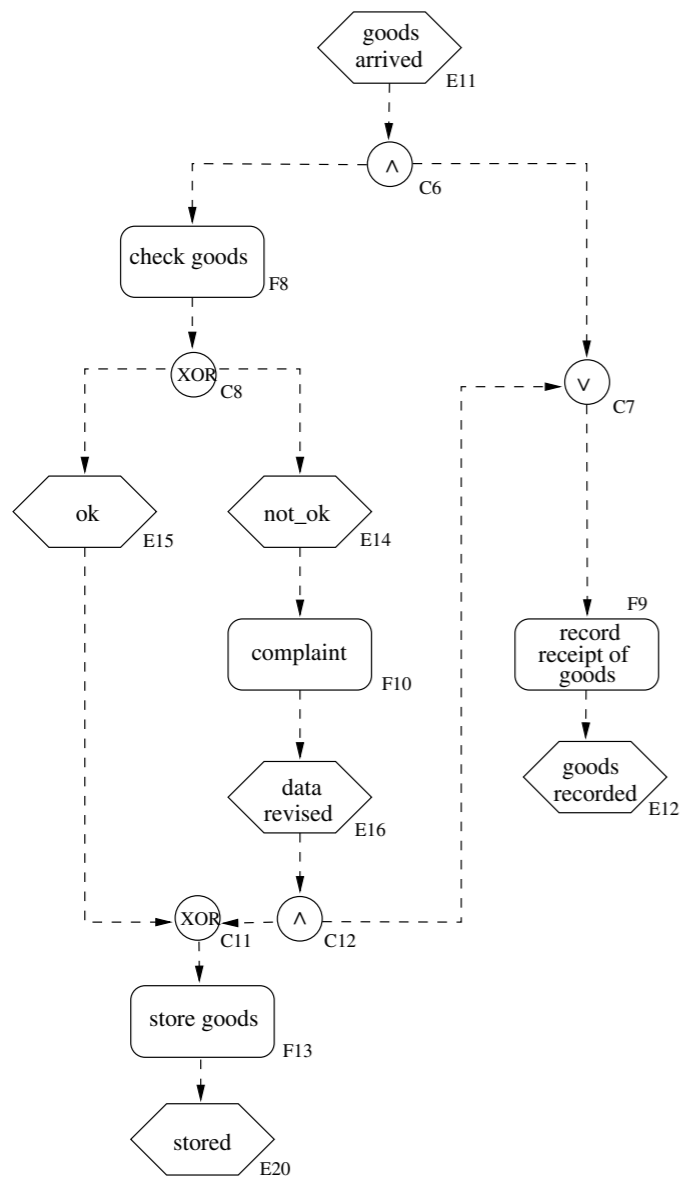

Example

Relaxed sound?

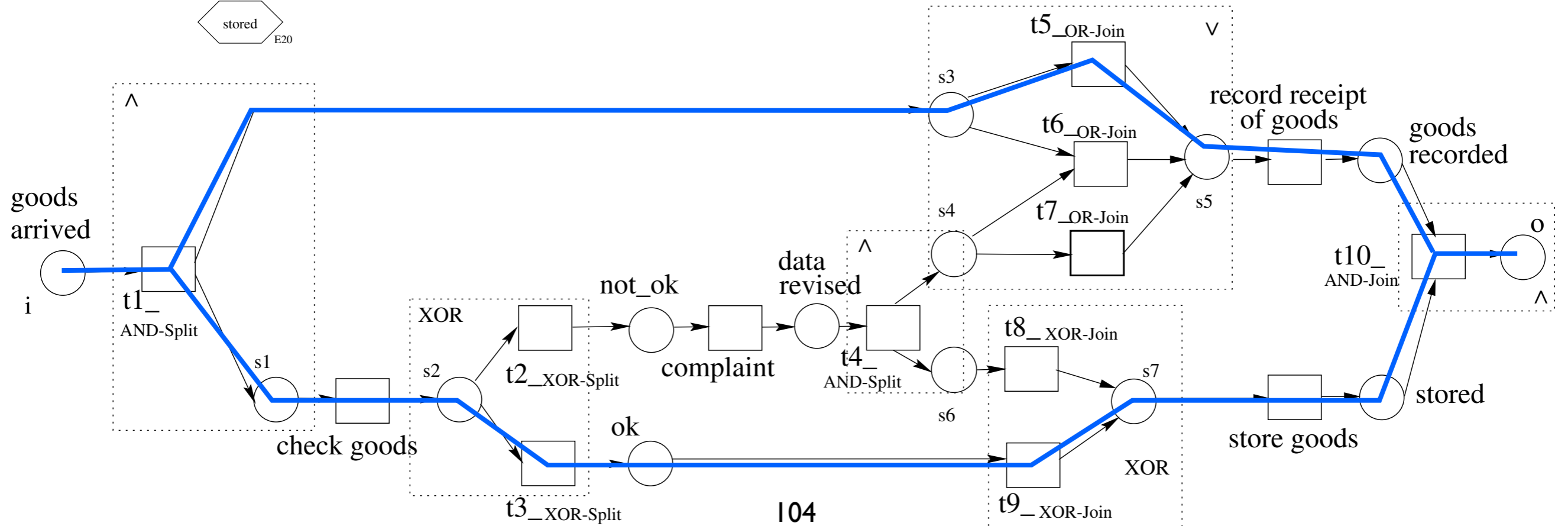
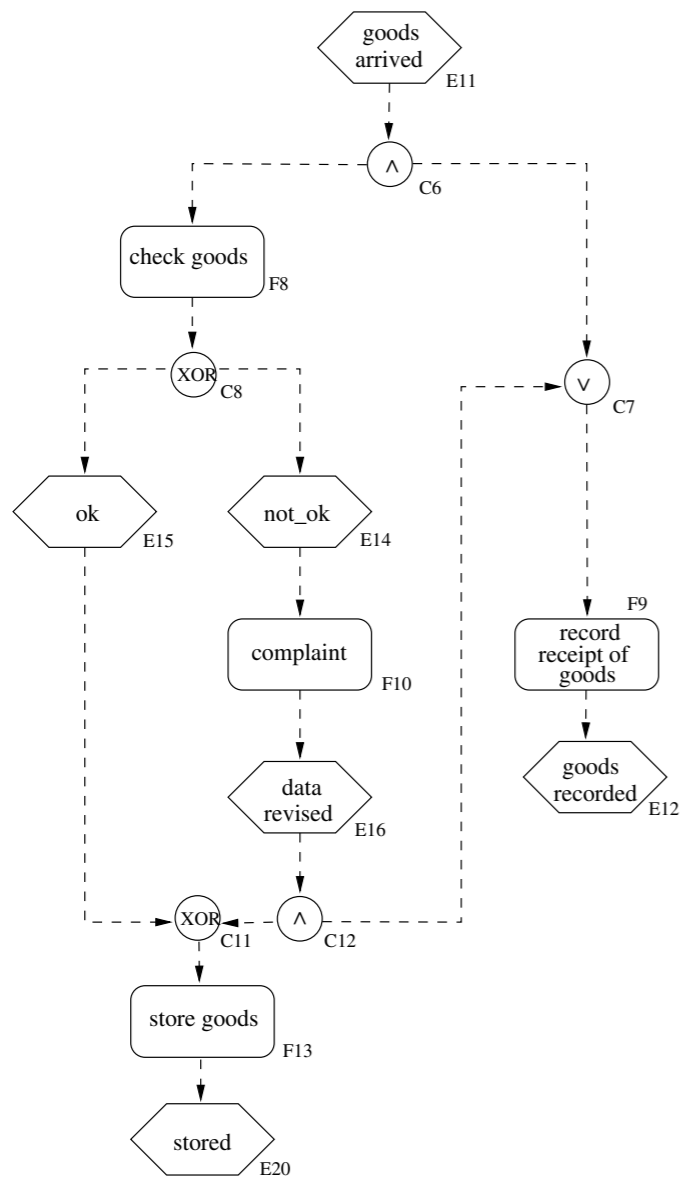

Example

Relaxed sound?

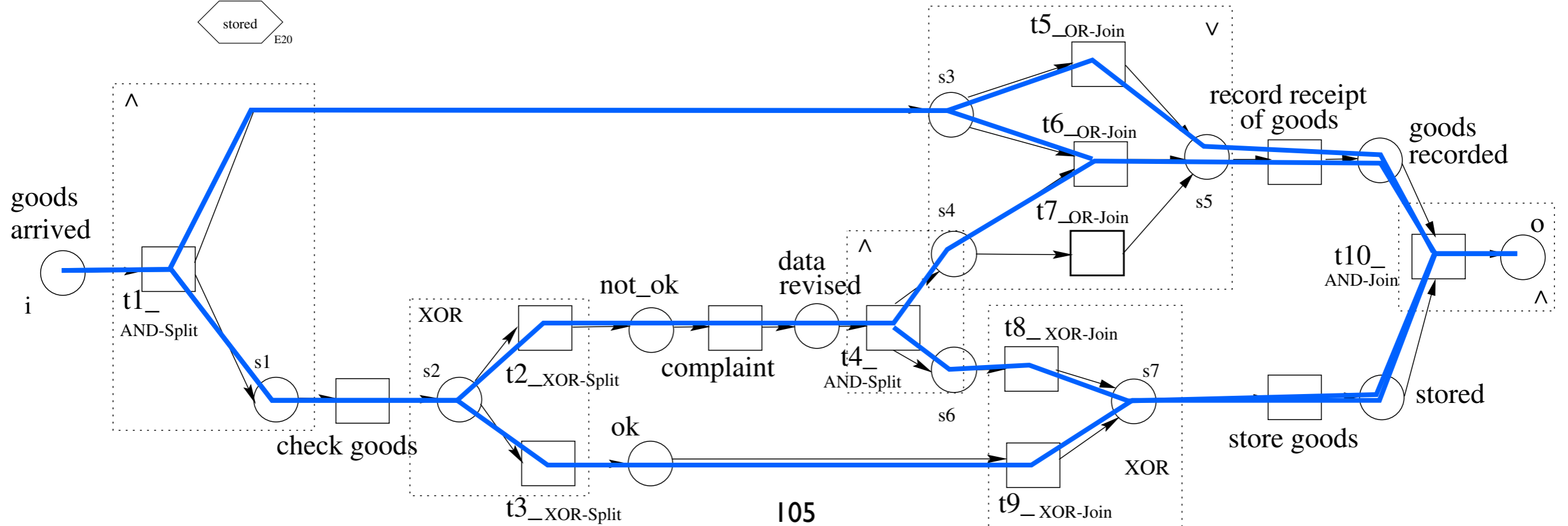
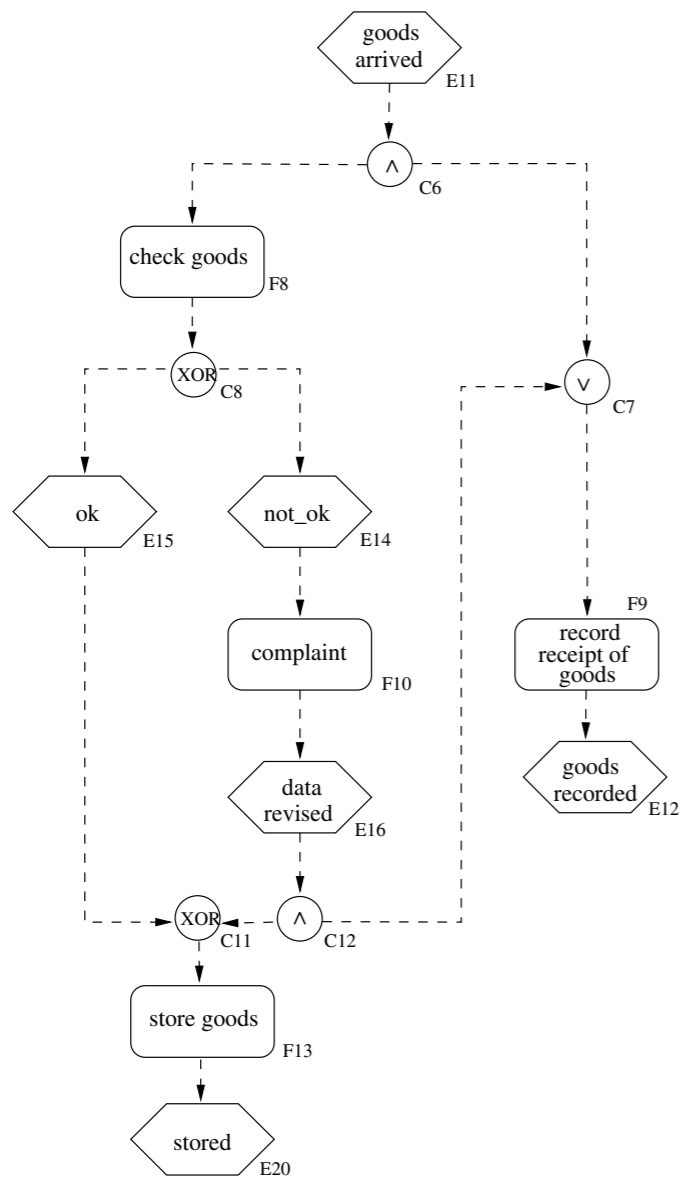

Example

Not relaxed sound (as WF net)!

But relaxed sound as EPC
(all nodes covered by some
sound execution)

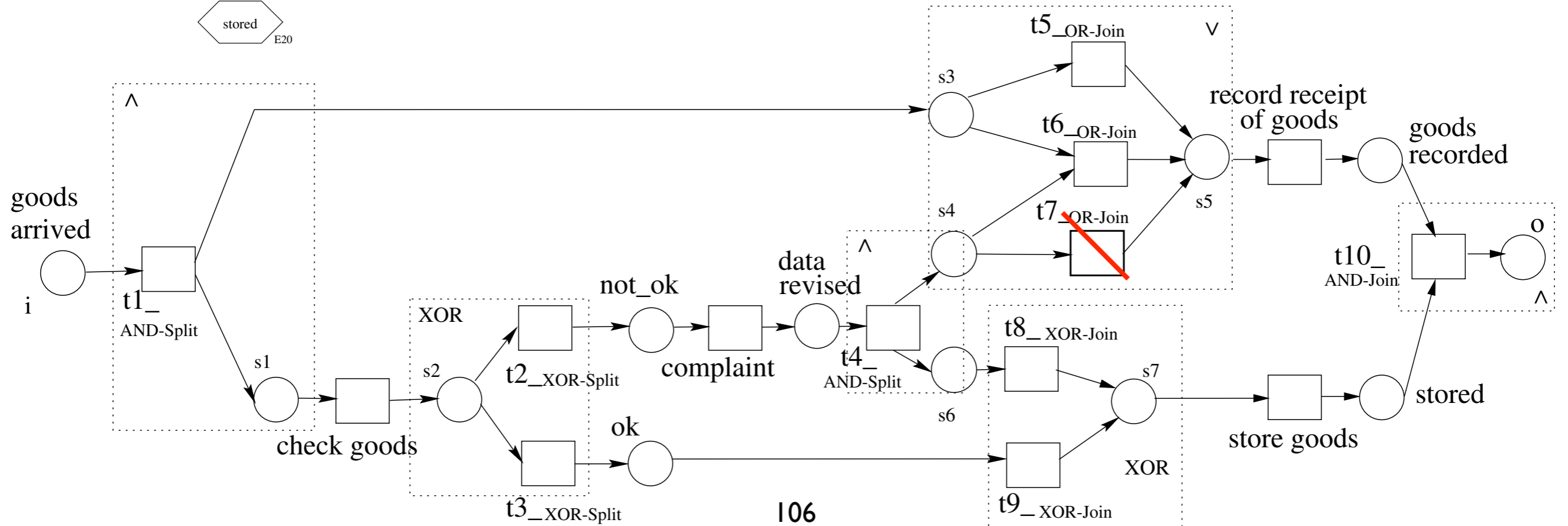
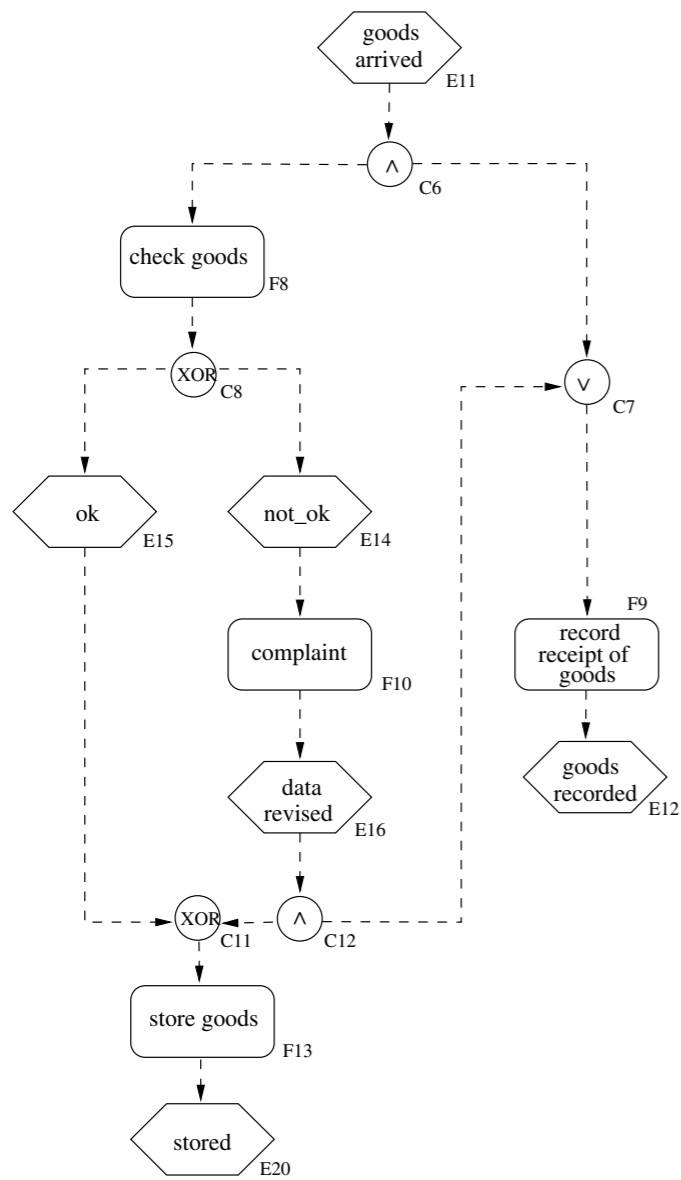

Pros and Cons

If the WF net is **not sound**:
there are transitions that are not contained in any sound firing sequence

Hence their EPC counterparts need improvements

Relaxed soundness can be proven only by enumeration
(of enough sound firing sequences)

No equivalent characterization is known
that is more convenient to check

Open research problem...