

*Corso di Percezione Robotica (PRo)*

*Prof.ssa Cecilia Laschi*

# Fondamenti di Robotica Biomimetica



Barbara Mazzolai



24 aprile, 2008

# Contenuti del modulo

## I Lezione:

- Introduzione alla biorobotica;
- Classificazione degli organismi viventi;
- Fondamenti della zoologia;
- 1° caso studio: robot bio-ispirati ai molluschi

## II Lezione:

- Artropodi
- 2° caso studio: robot bio-ispirati agli artropodi
- 3° caso studio: robot ispirato al geco
- Tecnologie di fabbricazione

**I PARTE**

**GLI ARTROPODI**

# The Animalia Kingdom



INVERTEBRATES

95%

(Animals without spinal cord)

*Sponges* (**phylum Porifera**)

*Jellyfish and sea anemones* (**phylum Cnidaria**)

*Flatworms* (**phylum Platyhelminthes**)

*Roundworms* (**phylum Nematoda**)

*Segmented worms* (**phylum Annelida**)

*Insects, spiders and crustaceans* (**phylum Arthropoda**)

*Snails, clams and squid* (**phylum Mollusca**)

*Starfish and sea urchins* (**phylum Echinodermata**)

VERTEBRATES

5%

(Animals with spinal cord)



# Phylum Arthropoda

✓ Subphylum Trilobito

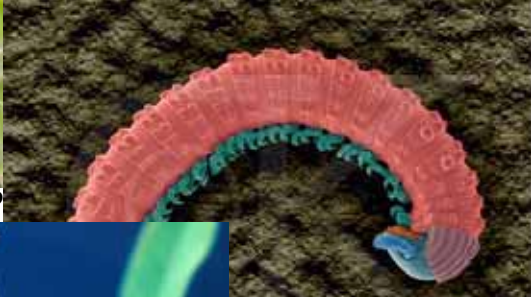
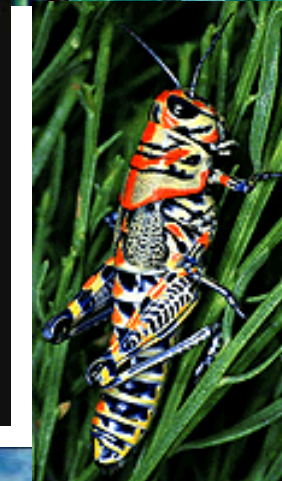

# PHYLUM ARTHROPODA

arthro = joint - poda = foot ----» jointed legs

- between 6-9 MILLION SPECIES
- 80% of described animal species are Arthropoda
- live in ALL environments and are tolerant of extremes

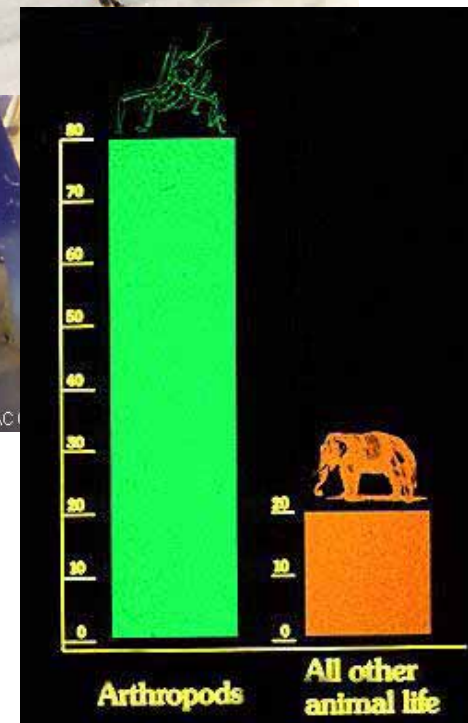

# Habitats

- 10,000 m deep in ocean – 6,000 high in mountains
- Air, land, fresh water, salt water, parasitic
- Some are social, live in groups



# Arthropoda - abundance

There are more species of insects than all other plants and animals together

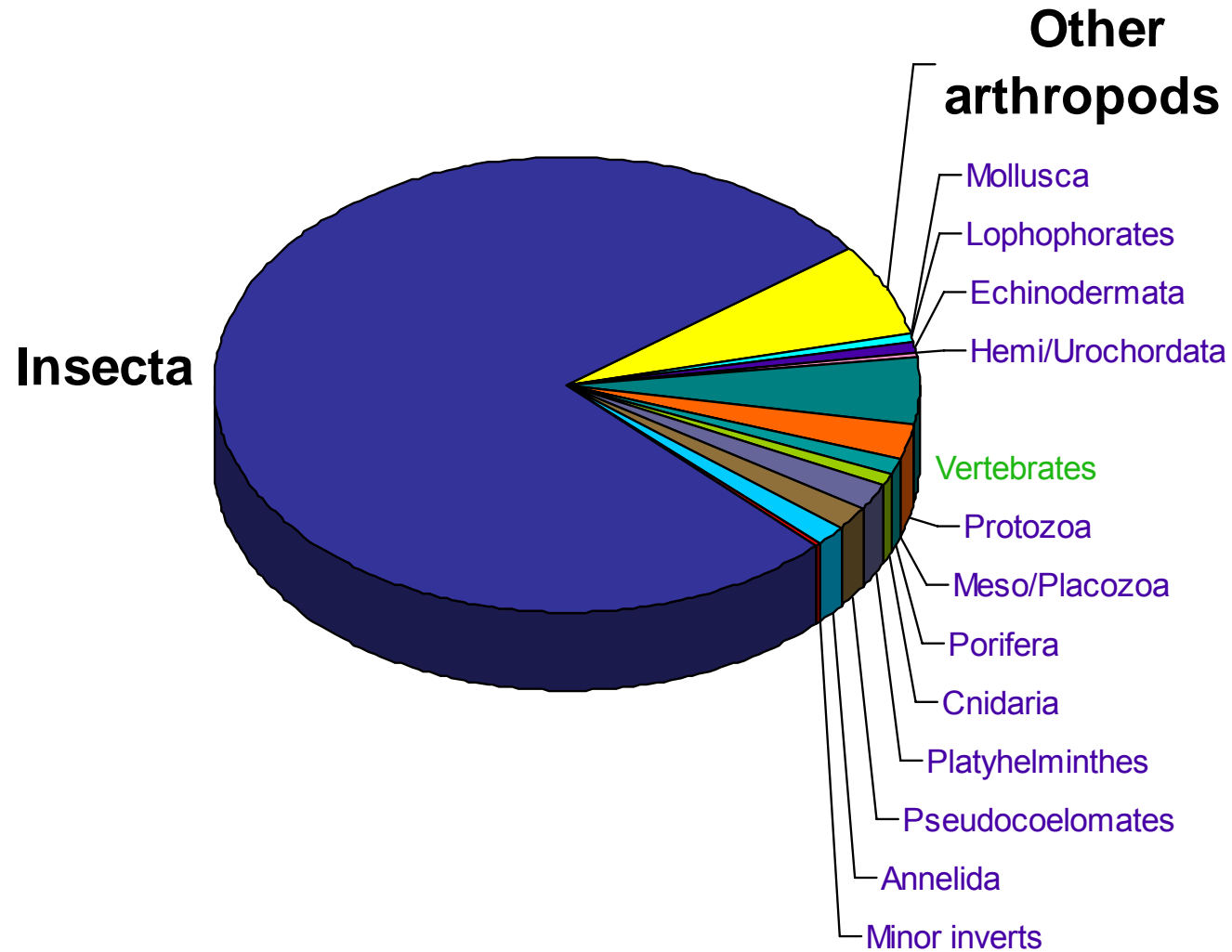



# Reasons for Success

1. Exoskeleton – protective, mobile
2. Segmentation & appendages – better locomotion
3. Tracheal system – more oxygen gets to cells
4. Sensory organs – highly developed to capture food, evade enemies
5. Complex behavior patterns/instincts – survival
6. Reduced competition for food – larvae eat different food than adult form eats

# Phylum Arthropoda

## How do Arthropods support themselves and move?

### 1. EXOSKELETON

The arthropod exoskeleton is made of **chitin** (N-acetylglucosamine, also found in the cell walls of fungi)

Secreted by **epidermis**.

In crustacea and millipedes, the cuticle is hardened by the addition of **calcium**; in insects, the cuticle is **tanned**, chemically bonded with protein.

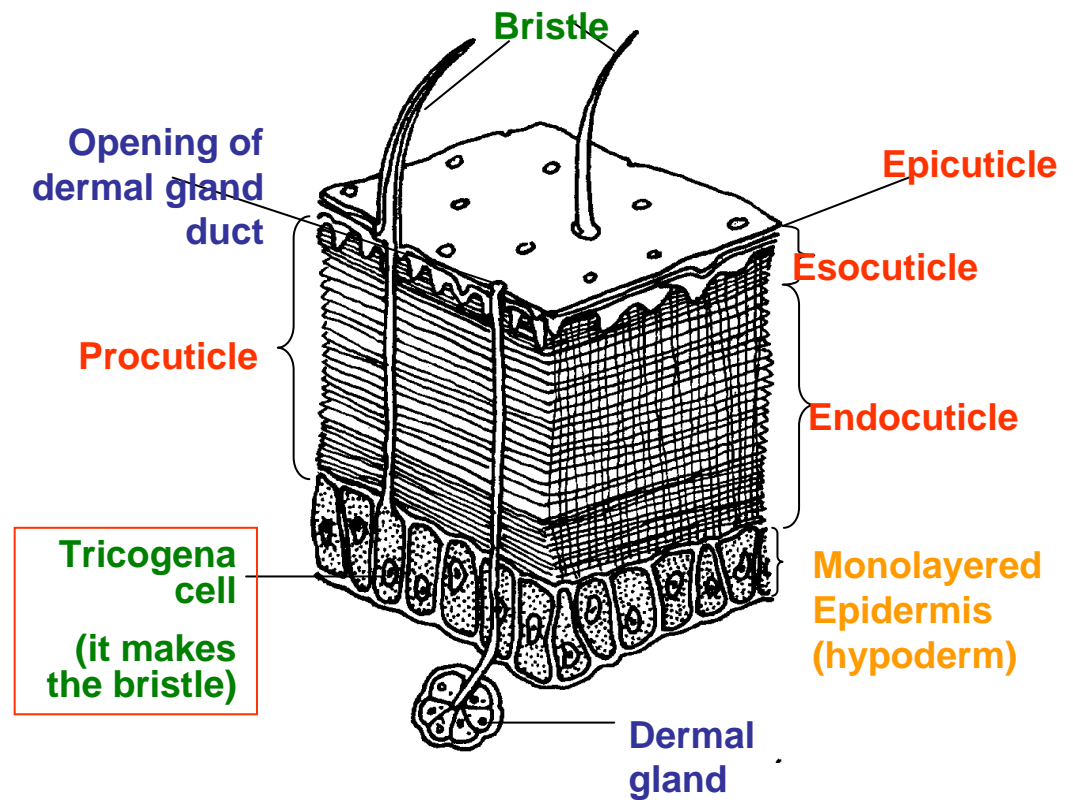

# Arthropoda - Exoskeleton

## Advantages:

1. Protection from drying - allowed invasion of land
2. Protection from predators

## Disadvantages:

1. Does not permit growth - have to moult
2. Does not bend - need to insert breaks (joints) in it to permit movement



# Phylum Arthropoda

2/6

## Characteristics

### 2. BODY SECTIONS

**METAMERISM** Body composed of **numerous segments** (somites), segmented condition may be concealed. In the primitive Arthropod, the body was thought to be a series of **metameres, each, except for the first and last, with a pair of appendages**. Metamerism is an example of an important biological trait, that of replication and modification to develop new traits and capabilities.

# Phylum Arthropoda

2/6

## Characteristics

### 2. BODY SECTIONS

Abdomen - digestion  
and reproduction

Thorax - locomotory

Head - sensory and  
feeding

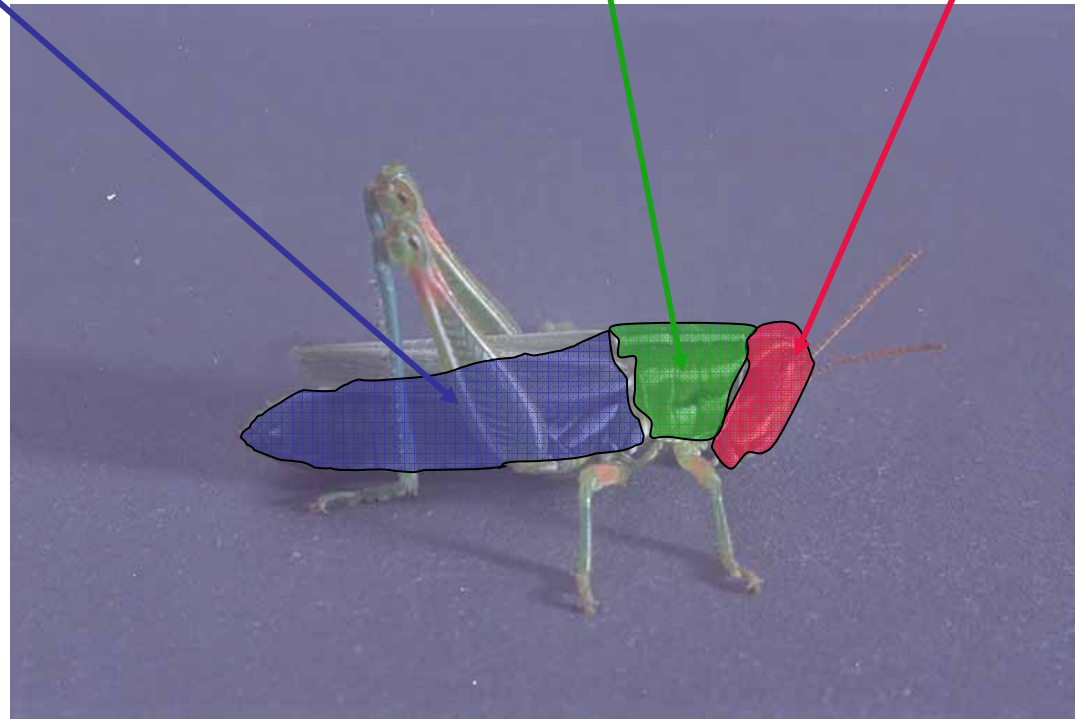

# Phylum Arthropoda

## Characteristics

- 3. JOINTED APPENDAGES.** Jointed appendages give arthropods numerous, generalized appendages which were modified into numerous specialized organs for **walking, swimming grasping, and eating**. These modifications account for much of the diversity and success of arthropods.
- 4. NERVOUS SYSTEM.** A complex nervous system with a brain (2-3 ganglia with specific functions) connected to a ventral solid nerve cord. Sensory information is processed in a central nervous system.

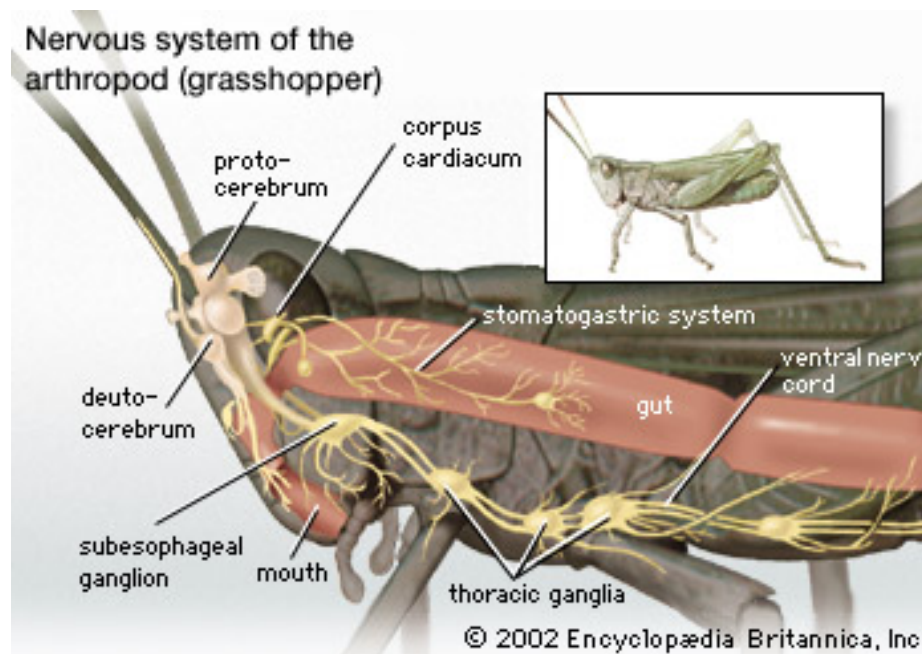
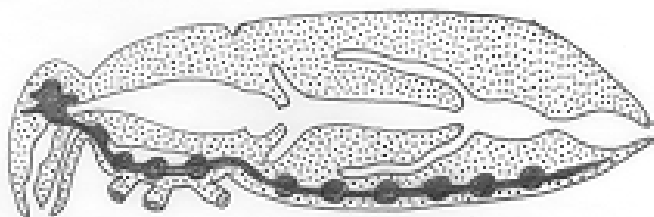

# Phylum Arthropoda

4/6

5. **SENSE ORGANS.** Exoskeletal sense organs include hairs sensitive to sound, touch, odour, taste, humidity or temperature, and often 2 compound eyes and 1 or more simple eyes.



Sense organs (**sensilla**) protrude out of cuticle.

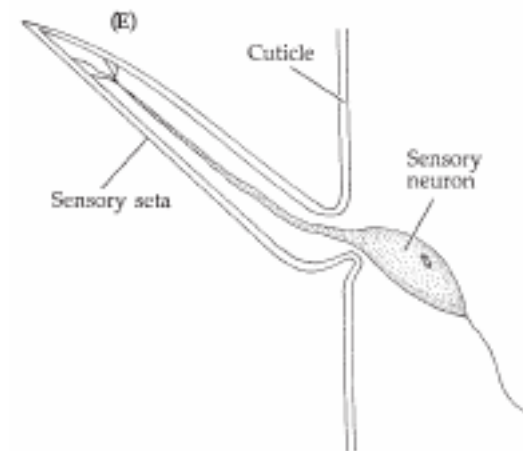

# Sense Organs

- Tactile hairs – on antennae, mouth parts, telson function in taste receptors (eg. pectines, tactile hairs, sensilla = mechanoreceptors)
- Chemoreceptors for olfaction (smell) on or near mouthparts
- Statocyst – located on first pair of antenna, for determining changes in body position (equilibrium)
- Simple or Compound eyes (photoreceptors) – made up of units called ommatidia





# Sense Organs

- Most arthropoda have sensory organs called statocysts
  - That contain mechanoreceptors and function in their sense of equilibrium

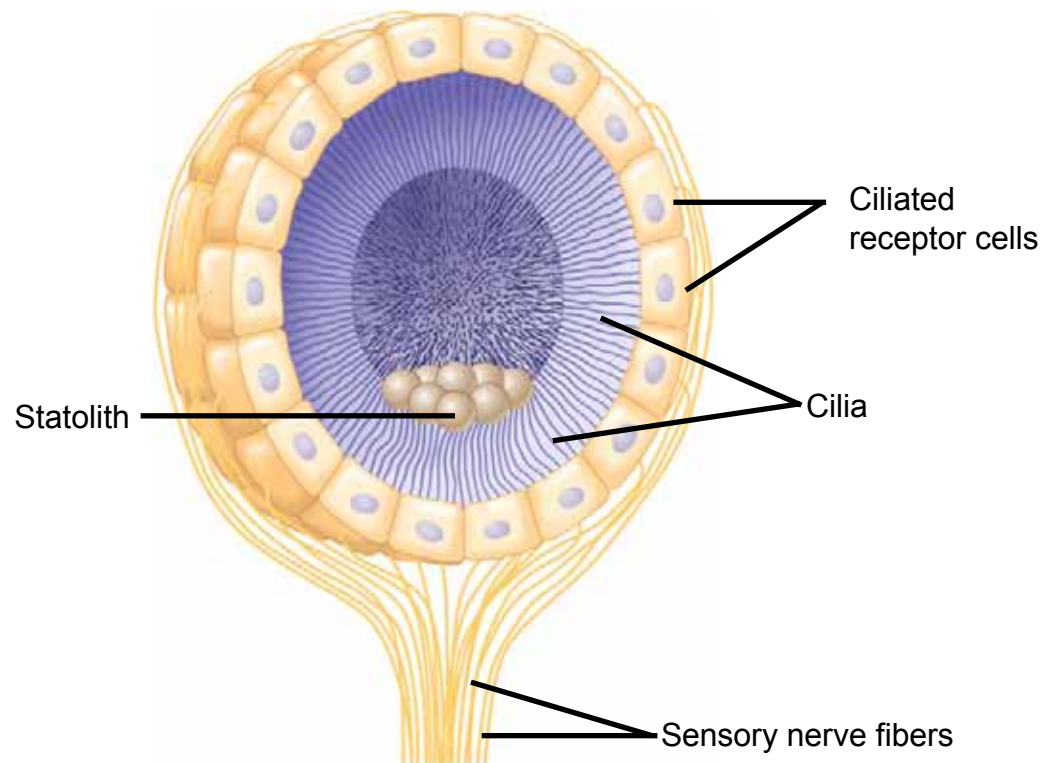

# Sense Organs

- Many arthropods sense sounds with body hairs that vibrate
  - Or with localized “ears” consisting of a tympanic membrane and receptor cells

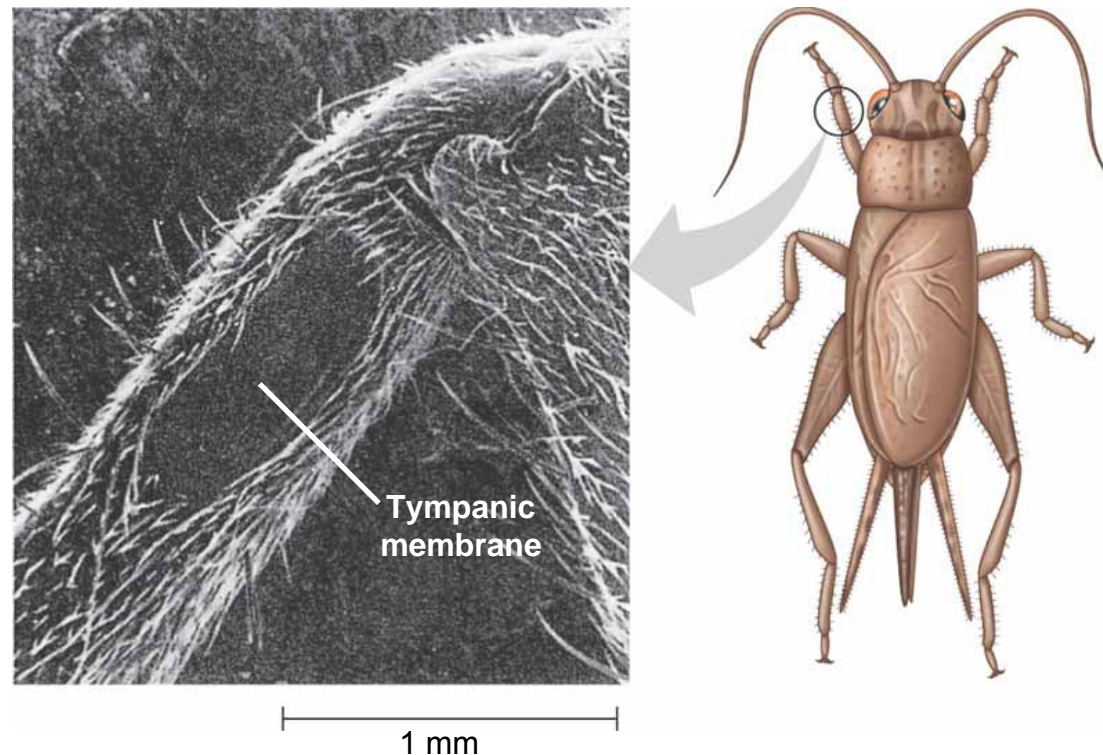

# Sense Organs

Compound eyes are found in insects and crustaceans

and consist of up to several thousand light detectors called ommatidia

(a) The faceted eyes on the head of a fly, photographed with a stereomicroscope.



(b) The cornea and crystalline cone of each ommatidium function as a lens that focuses light on the rhabdom, a stack of pigmented plates inside a circle of photoreceptors. The rhabdom traps light and guides it to photoreceptors. The image formed by a compound eye is a mosaic of dots produced by different intensities of light entering the many ommatidia from different angles.

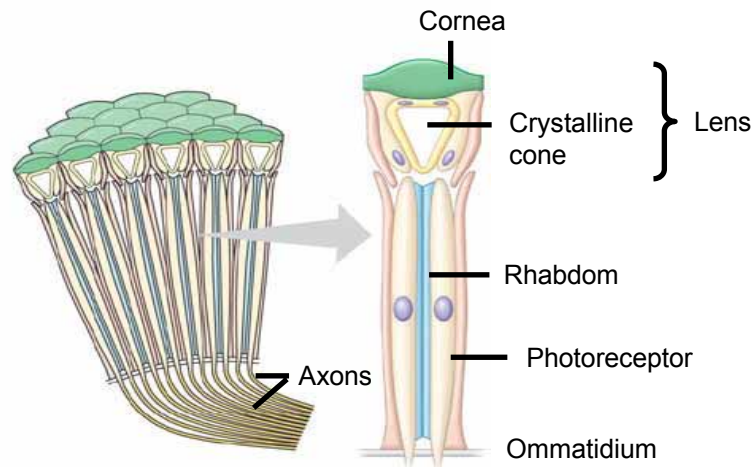

# Phylum Arthropoda

## Characteristics

- 6. RESPIRATORY SYSTEM.** A unique respiratory system that employs a variety of respiratory organs. Marine arthropods utilize **gills** composed of a vascularized, thin-walled tissue specialized for gas exchange. Terrestrial forms have **book lungs** (e.g., spiders) or **tracheae** (e.g., insects). Book lungs are invaginations to serve in gas exchange between air and blood. Tracheae are air tubes that serve as ways to deliver oxygen directly to cells.
- 7. OPEN CIRCULATORY SYSTEM** A dorsal (upper) vessel directs blood forward toward the brain, an open system allows the blood to circulate back through the body.

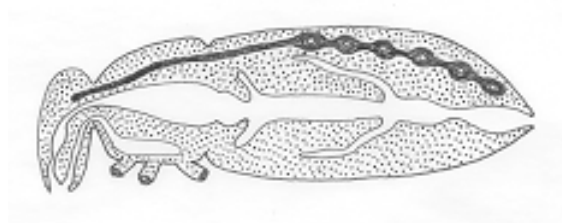

- 8. BILATERAL SYMMETRY** Body can be divided into two equal halves through one plane. This promotes **forward movement**, allowing the **head's sensory organs, the eyes and antennae, meet the world first. Most animal groups that are very active are bilaterally symmetrical.** But not all animals have bilateral symmetry, some have radial symmetry, e.g. jellyfish.

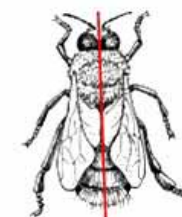

# Phylum Arthropoda

## Characteristics

9. **ENDOSKELETON.** At certain precise points or lines on the surface of the body, **integumental invaginations** extend into the haemocoel, forming either simple apodemes, or well-developed plates, or even more complex cuticular structures, all used for muscle attachments. These structures form part of the endoskeleton.
10. **MOLTING.** In order to grow, an arthropod must shed its old exoskeleton and secrete a new one. This process, molting, is expensive in energy consumption. During the molting period, an arthropod is **vulnerable**. Once their cuticle hardens they can't grow ever again. Their cuticles slowly expand as they increase in mass. They breakdown (digest) their cuticle every now and then when they need to grow. Their cuticle hardens at their adult size and they slowly grow to fill it up.
11. **LIFE CYCLE.** A complex, yet adaptable, life cycle. **Metamorphosis** is a drastic change in form and physiology that occurs as an immature stage becomes an adult. **Metamorphosis contributes to the success of arthropods because the larval stage eats food and lives in environments different from the adult; reducing competition between immature and adults of a species.** Reduction in competition thus allows more members of the species to exist at one time.

# Complete Metamorphosis (Holometabolous)

- Each of the developmental stages is structurally and functionally very different
- The egg develops into an immature **larva**; eats voraciously
- Followed by a transitional stage - **pupa**, contained within cocoon
- Metamorphosis occurs within the pupal exoskeleton, yielding a sexually mature **adult**

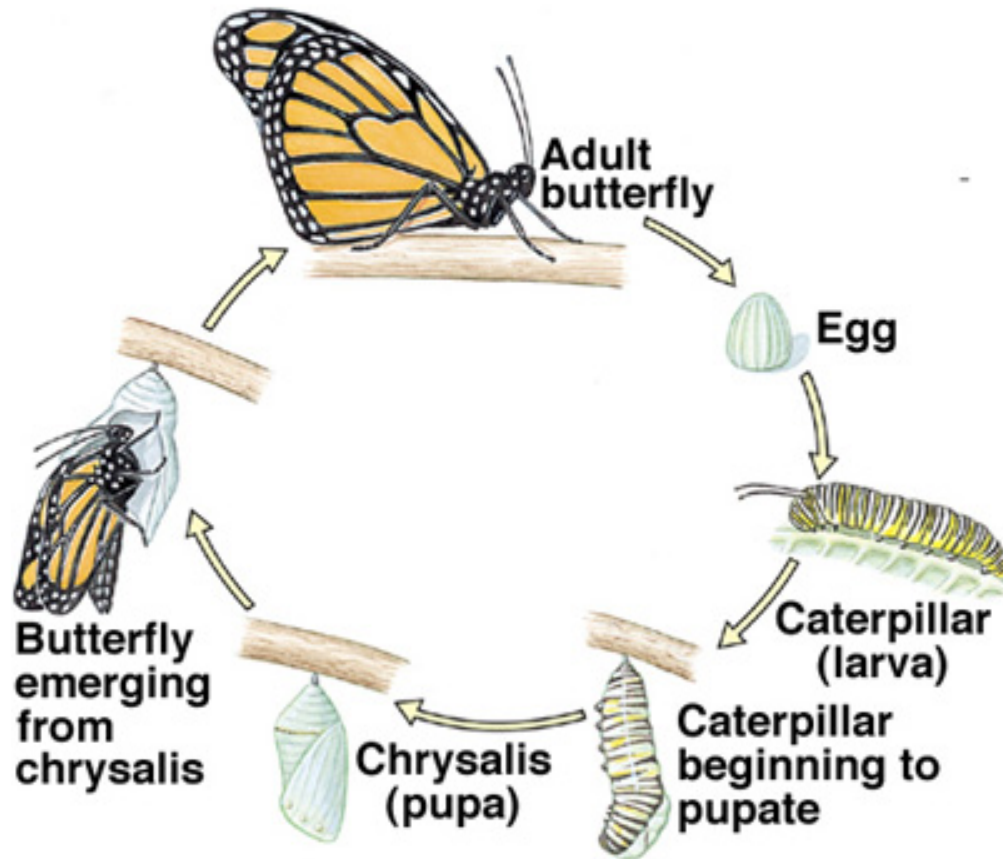

# Phylum Arthropoda - Summary

1. Bilateral Symmetry
2. Head, thorax & abdomen
3. Appendages with hinge joints (1 pair/segment)  
segment = somite
4. Exoskeleton
5. Open circulatory system
6. Respiration – gills, tracheal tubes, booklungs
7. Brain, ventral nerve cord
8. Dioecious w/ metamorphosis and  
parthenogenesis (unfertilized egg develops)

# Arthropoda locomotion

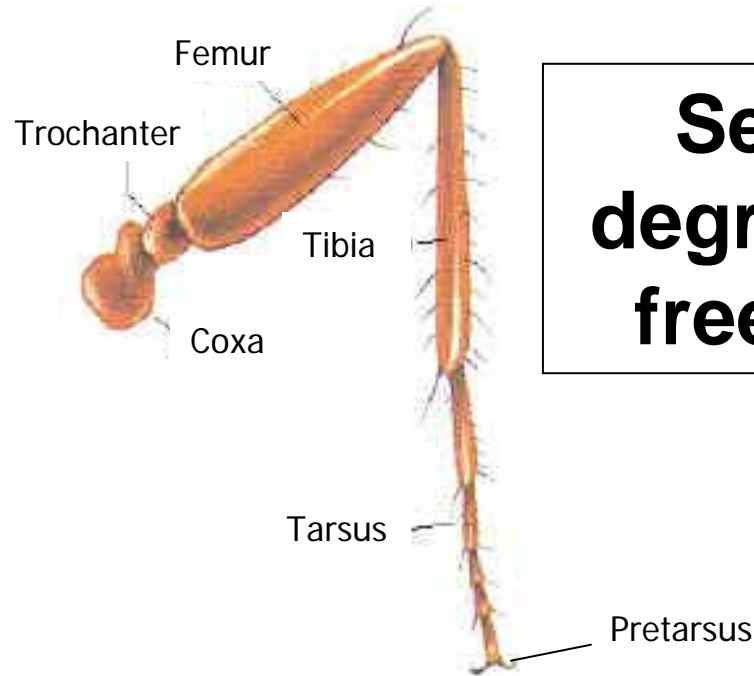

**Seven  
degrees of  
freedom**



***Crab Leg***



***Insect Leg***



Honeybee leg



Mole Cricket leg



Water Beetle leg



# ARTHROPOD EXOSKELETON Mechanics

1. Flexible joints form lever system
2. Exoskeleton provides high stiffness per weight

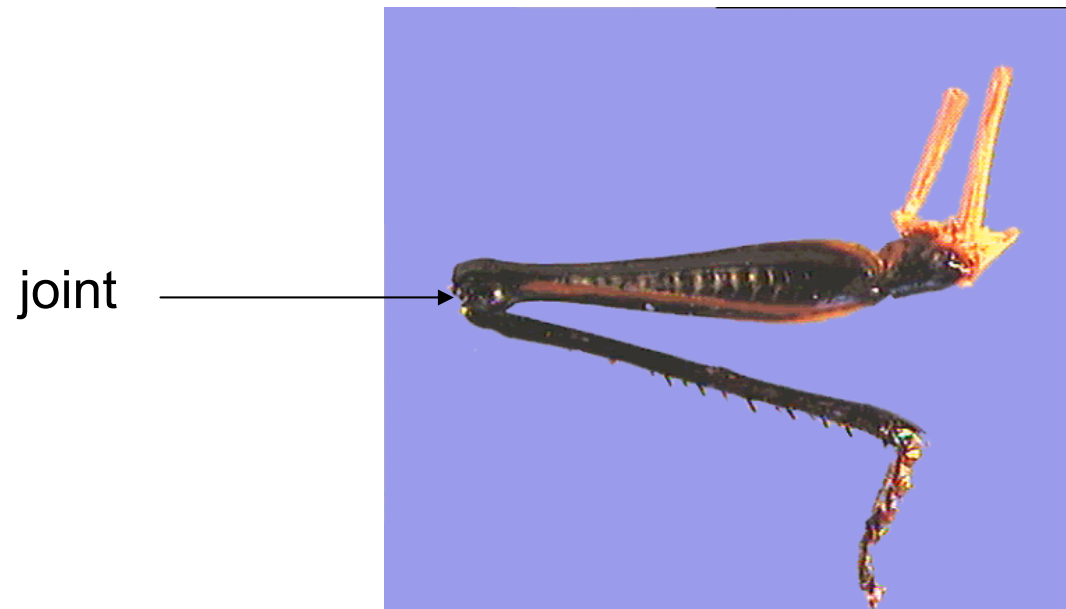

# ARTHROPOD EXOSKELETON Mechanics

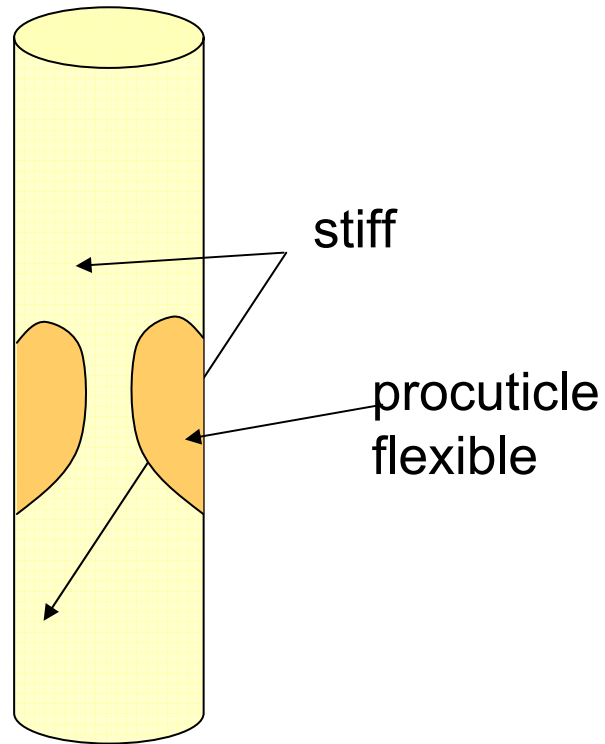

Weight can be placed on foot  
without compressing leg but  
joint is still flexible.

# How do Arthropods support themselves and move?

Joints have thin flexible membrane.

Antagonistic muscles: **flexors** and **extensors**.

Joints in one plane or ball-and-socket.

Exoskeleton has **condyles** that act as fulcrums.

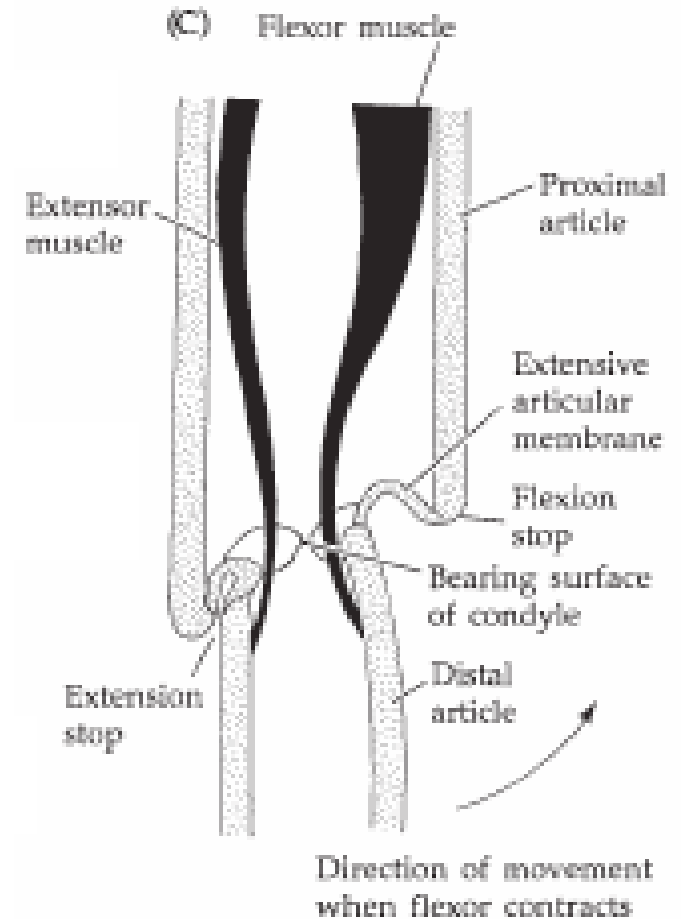
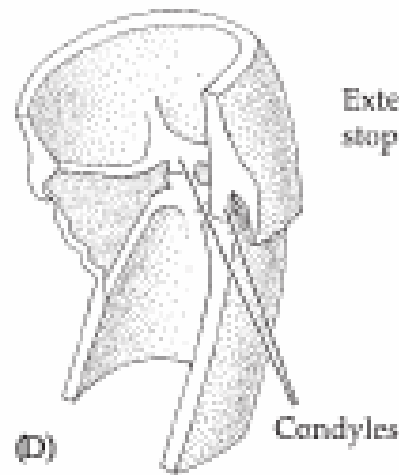

# Anatomical Terminology

- **Flexion** = bending two parts of the body toward each other, versus,
- **Extension** = bending of two parts away from each other (ex. Forelimb)

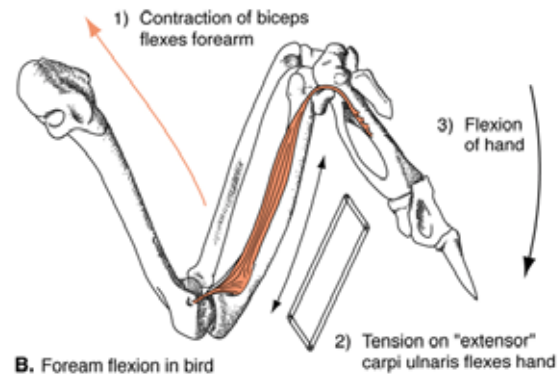
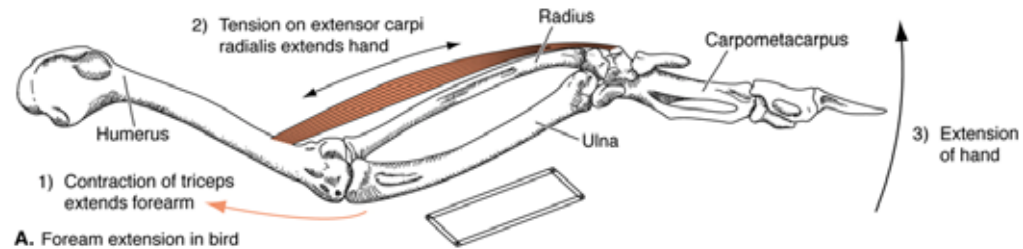

# Skeletal muscles are attached to the skeleton in antagonistic pairs

With each member of the pair working against each other

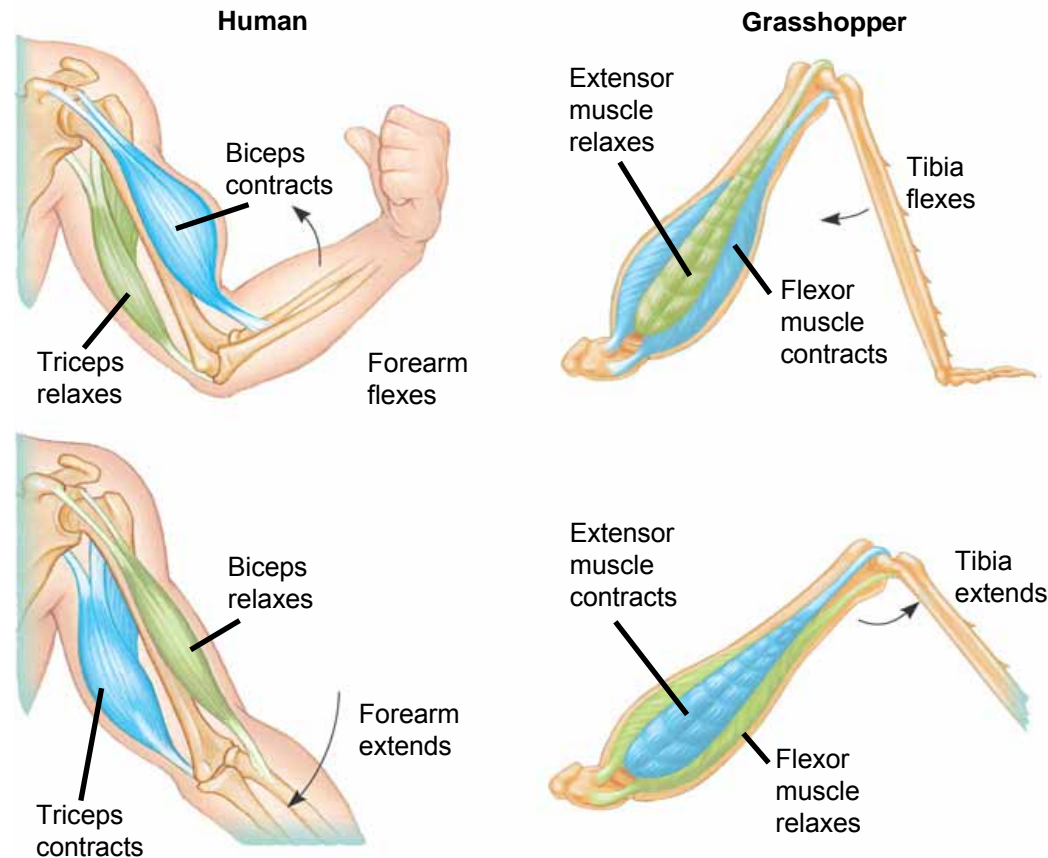

# How do Arthropods support themselves and move?

## Walking

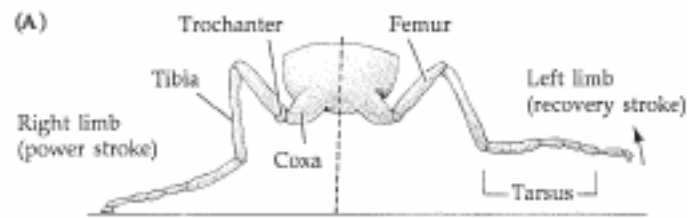

Walking involves the coordinated movement of uniramous appendages in different planes.

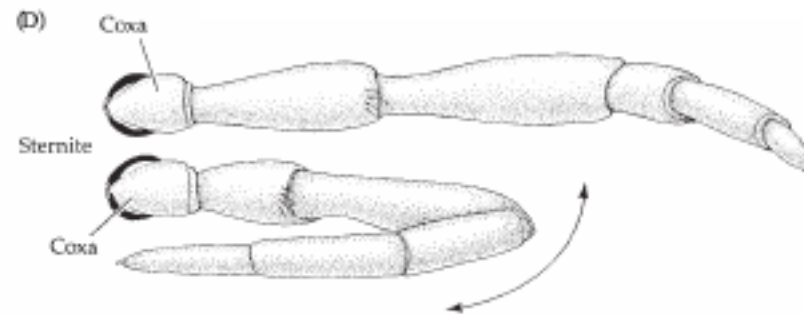
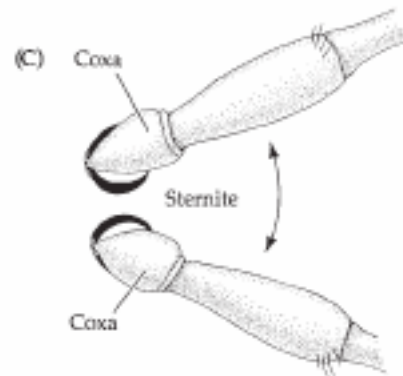
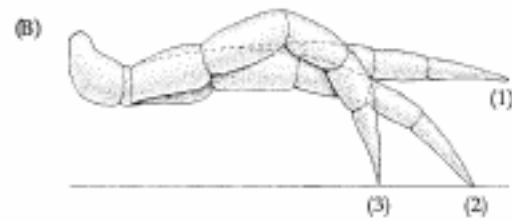

# How do Arthropods support themselves and move?

Swimming

Flapping phyllopodia

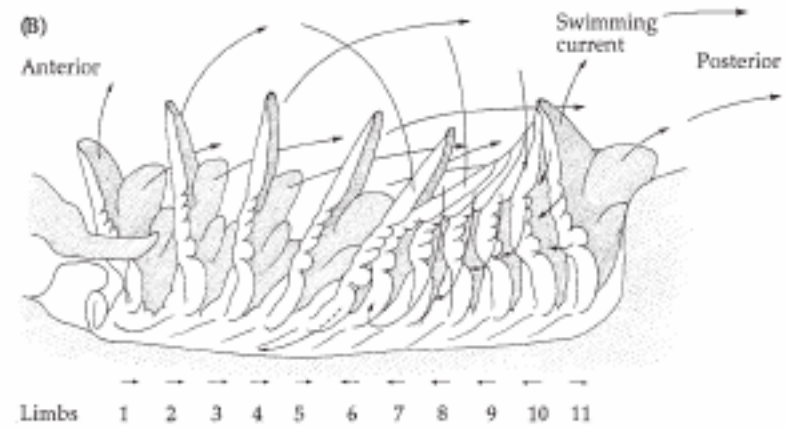

Tail flexion



# How do Arthropods support themselves and move?

## Flying

### Dorsoventral and longitudinal muscles

- Dorsal longitudinal muscles relaxed/dorsoventral muscles contracted: the wings are up.
- Dorsal longitudinal muscles contracted/dorsoventral muscles relaxed: the wings are down

### Flexible thorax.

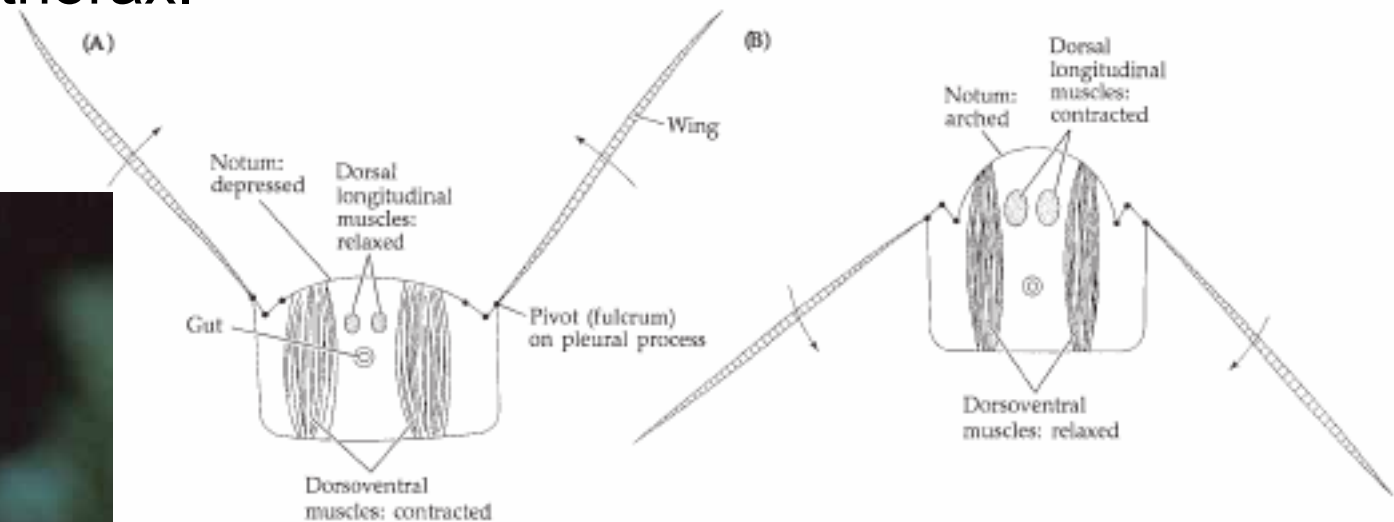



# Arthropoda locomotion - Summary

Since **exocuticle is absent from joints**, arthropods can move appendages and flex one body segment on another.

Movement results from **contraction and relaxation of striated muscle fibres**. Most arthropods use their appendages for movement, for example, as paddles in aquatic species or as legs in terrestrial ones.

## Muscular System

- complex, demonstrating **antagonistic muscle actions**
- **striated, skeletal muscles** for rapid movement
- **smooth muscles** for movement of internal organs

## Mechanism/Mode of Locomotion

- **antagonistic muscle action in jointed appendages** for walking, swimming and/or flying
- flying may be via **direct or indirect muscle contraction** in thorax of insects

# Convergent evolution and locomotion through complex terrain by insects, vertebrates and robots

Which aspects of the animal's locomotion are most important to the robotic designs?

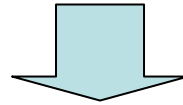

**CONVERGENT EVOLUTION**

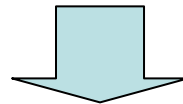

This convergence occurs because principles of **physics** limit the number of good solutions that are available. Legged locomotion evolved independently by vertebrates and arthropods, but many similarities are found in both groups.

Both animal groups must solve the same **physical problems** relevant to moving a body through natural terrain against forces such as **gravity** and **friction**.

# Comparison to vertebrate patterns

The specific movements of the front and rear legs of the cockroach are in many ways similar to the actions seen in quadruped vertebrates, and specially mammals.

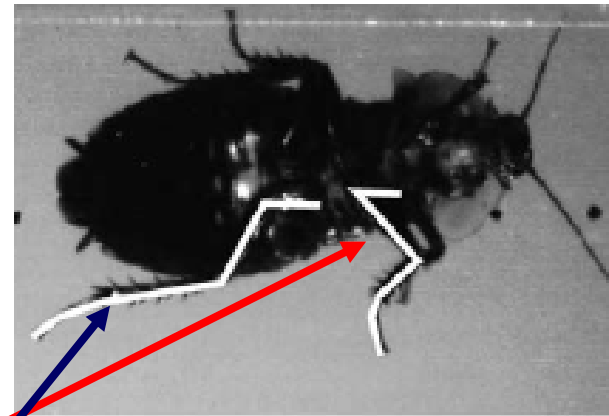
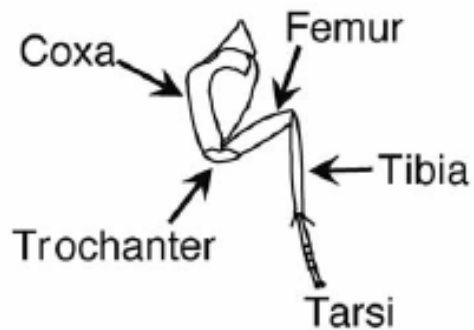

**Front legs provide braking and searching movements**

**Rear legs provide power for forward locomotion**

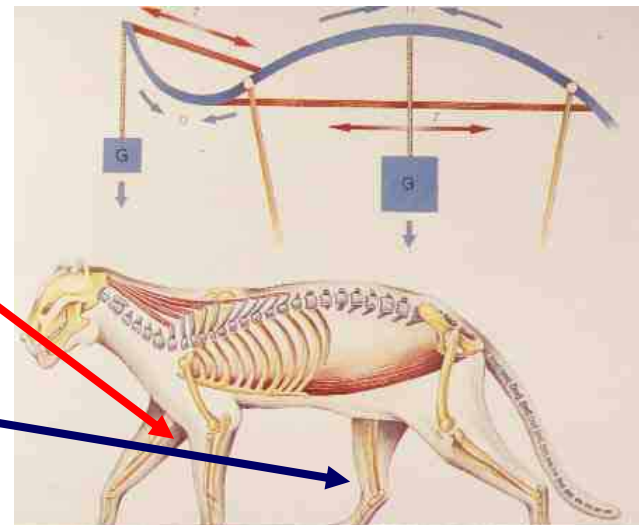

# **II PART**

## **CASE STUDIES ON ARTHROPODA INSPIRED ROBOTS**

# Artropod Inspired - Biomimetic robots

**GOAL** of the research: development of a **new class of biologically inspired robots that exhibit much greater robustness in performance in unstructured environments** than today's robots. This new class of robots will be substantially more **compliant** and **stable** than current robots, and will take advantage of new developments in materials, fabrication technologies, sensors and actuators.

# Artropod Inspired - Biomimetic robots

*A strict bio-mimicry strategy is rarely if ever successful for several reasons*

1. Even though insects are often referred to as simple animals, their **mechanical** and **nervous systems** are far more complex than that found in any current robot
2. Each **leg** has seven degrees of freedom
3. The **muscles** that control those movements are more efficient than **any artificial actuators currently available**
4. **Thoracic ganglia** contain thousands of neurons and head ganglia represent **sophisticated sensory processing regions**, **memory banks** and **motor control centers**
5. Hundreds of **sensors** are found associated **with each leg** and on the **head**, **antennae** may have hundreds of thousands of sensors associated with them
6. Insects are **small** creatures and body plans may be optimized for the **size** and **materials** found in their bodies. As one scales up to larger devices typical of most robots and changes to materials such as **aluminum** or **plastic**, it is not clear that these designs will still be appropriate
7. **Neural circuits** are rarely understood in their entirety and again **have co-evolved** with the size and materials of the insect's body

# Stanford-Barkley approach to the problem: The Rhex and Sprawl robot series



R.J. Full  
Dept. of Integrative  
Biology  
U.C. Berkeley

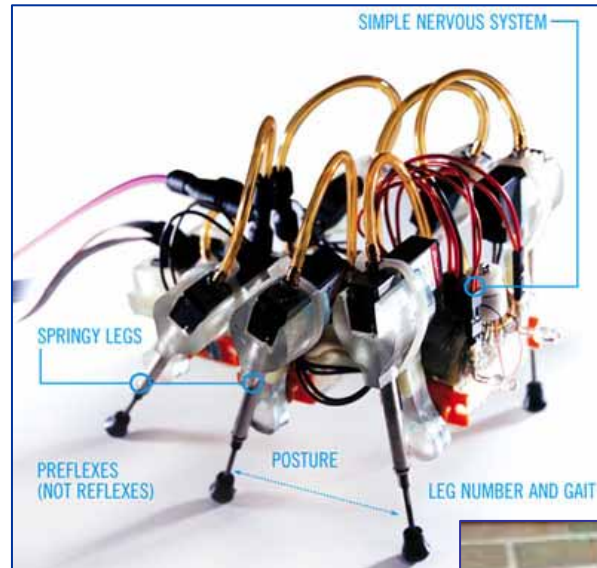

M.R. Cutkosky  
Center for Design  
Research  
Stanford University



# Mechanical aspects of legged locomotion control

“Rather than seeking to copy any specific morphological or even physiological detail, we hypothesize functional principles of biological design and test their validity in animal and physical models”.

## Bioinspiration for **hexapedal running**

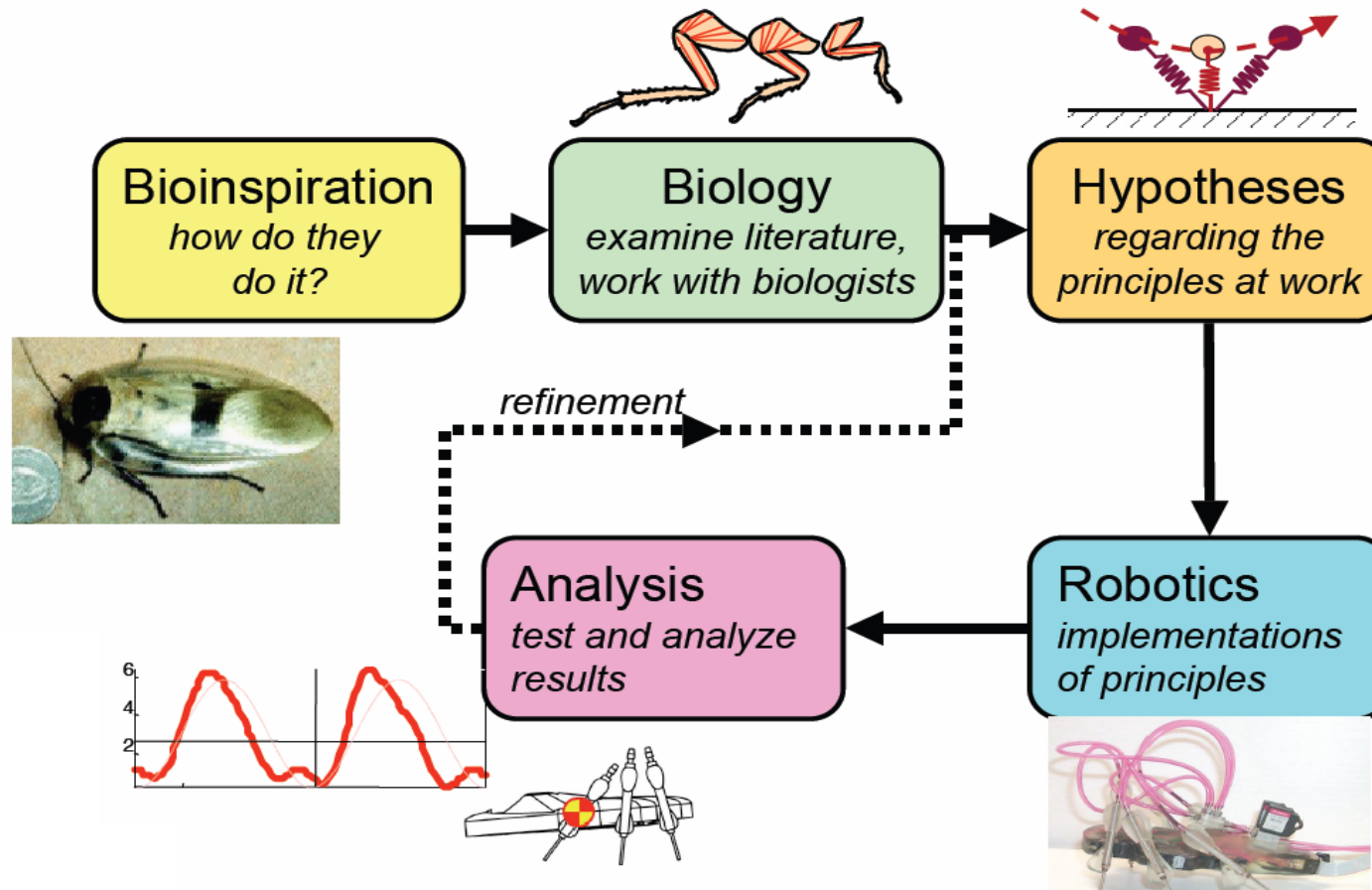



# *Motivation*

- Hazardous tasks for humans
- Access to areas inaccessible to wheeled vehicles
- Legged animals are faster and more agile in rough terrain



# Stanford-Barkley approach

## DESIGN INSPIRATION FROM BIOLOGY

**WHY ARTHROPODS:** are capable of remarkable **speed** and **stability** over uneven and uncertain terrain. *Periplaneta americana* can achieve speeds of up to **50 body-lengths per second** (Full and Tu, 1991). *Blaberus discoidalis* is capable of traversing uneven terrain with **obstacles of up to three times the height of its center of mass** without appreciably slowing down (Full et al., 1998) and achieves 30-40 cm/s.



Studies of these cockroaches suggest design principles for fast, stable, running hexapods:

- 1. Self-stabilizing posture**
- 2. Thrusting and stabilizing leg function**
- 3. Passive visco-elastic structure**
- 4. Timed, open-loop/feedforward control**

# 1. Self-stabilizing Posture

**STABILITY** is essential to the performance of terrestrial locomotion.

Arthropods are often viewed as the quintessential example of a **statically stable** design.

**POSTURE:** Arthropod legs generally **radiate outwards**, providing a wide base of support. Their **center of mass** is often so low that their body nearly scrapes the ground.

Their sprawled postures reduce **over-turning moments**.



*Periplaneta americana*

**Self-stabilizing posture:** A rear and low centre of mass and wide base of support contribute to the over-all stability of locomotion.

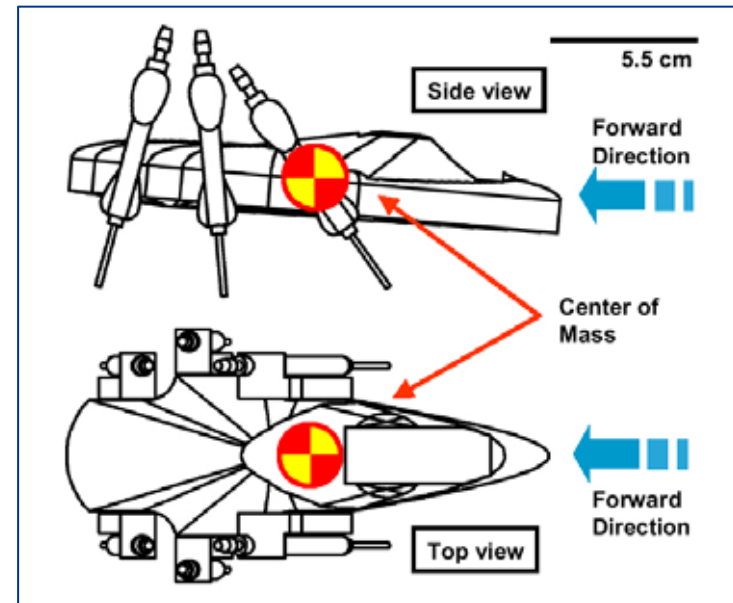
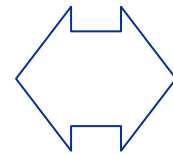

## 2. Thrusting and Stabilizing Leg Function (I)

In the cockroach's wide sprawled posture, the **front legs** apply this thrusting mainly for **deceleration**, while the **hind legs** act as powerful **accelerators**. Middle legs both **accelerate and decelerate** during the stride. The creation of large internal forces may be inefficient for smooth, steady-state running, but there is evidence this contributes to dynamic robustness to perturbations (**Kubow and Full, 1999**) and to rapid turning (**Jindrich and Full, 1999**). A similar leg function has been designed in the robot.

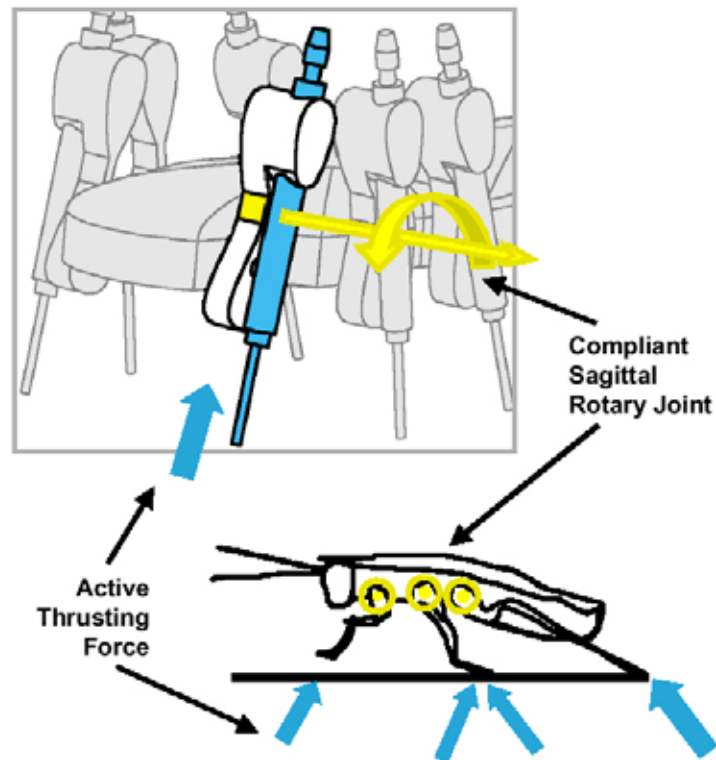

## 2. Thrusting and Stabilizing Leg Function (I)

- Sprawled posture
- Individual leg function
- Front legs decelerate, hind legs accelerate, middle legs both accelerate and decelerate during the stride
- Self-correcting forces with respect to the geometry

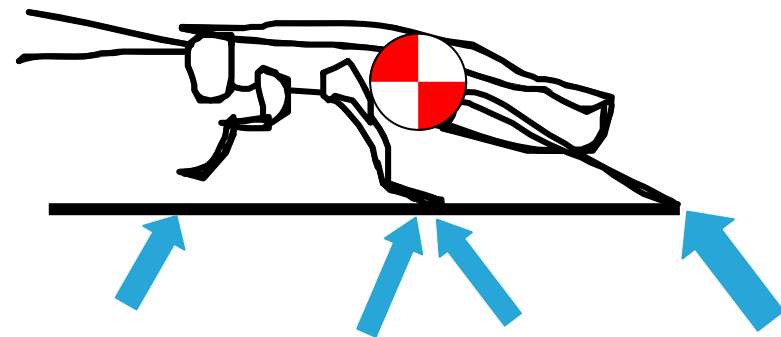
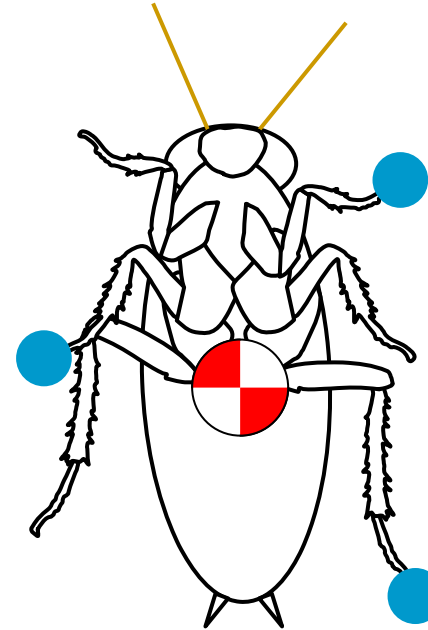

## 2. Thrusting and Stabilizing Leg Function (II)

**Leg Function:** Studies of **ground reaction forces** in cockroach locomotion show that **forces** are directed towards the **hip joints**, essentially acting as **thrusters**.

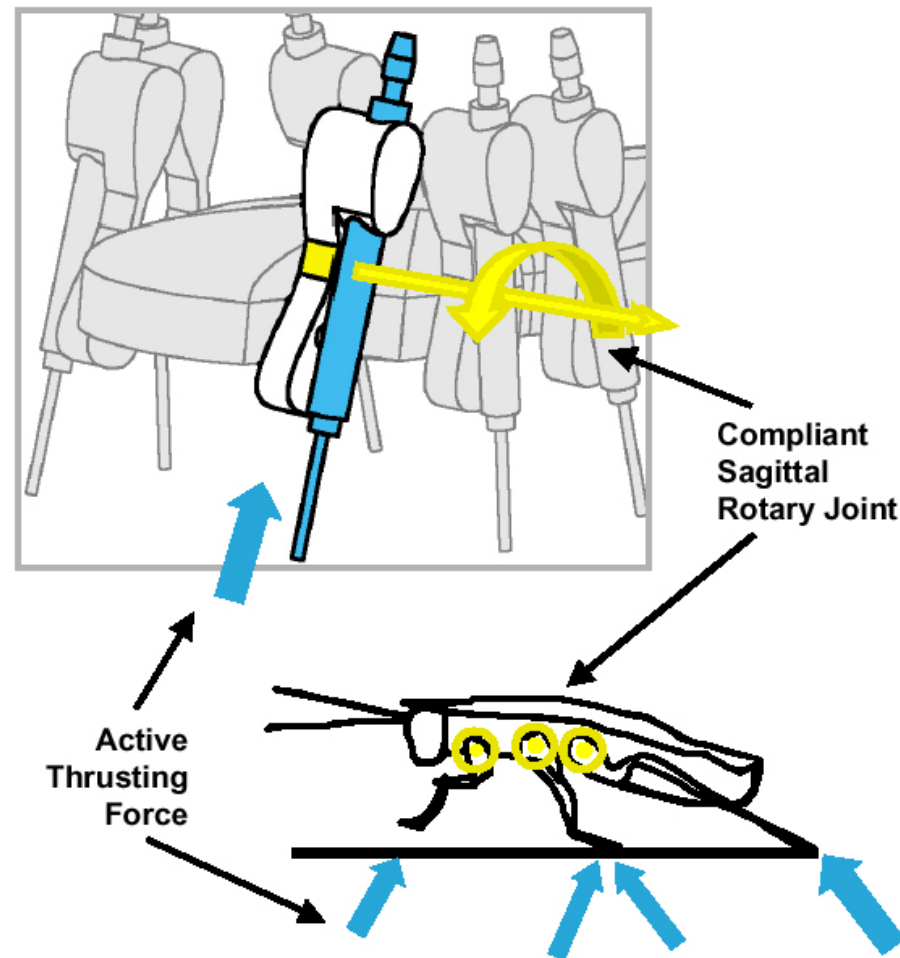

## 2. Thrusting and Stabilizing Leg Function (II)

In the first Sprawl robot versions, the primary thrusting action was performed by a ***pneumatic piston***. This piston was attached to the body through a **compliant rotary joint at the hip**. This unactuated rotary joint is based on studies of the cockroach's **compliant trochanter-femur joint**, which is believed to be largely passive.

Servo motors rotate the base of the hip with respect to the body, thus setting the nominal, or equilibrium, angle about which the leg will rotate. **By changing this angle, we can affect the function that the leg performs by aiming the thrusting action towards the back (to accelerate) or towards the front (to decelerate).**

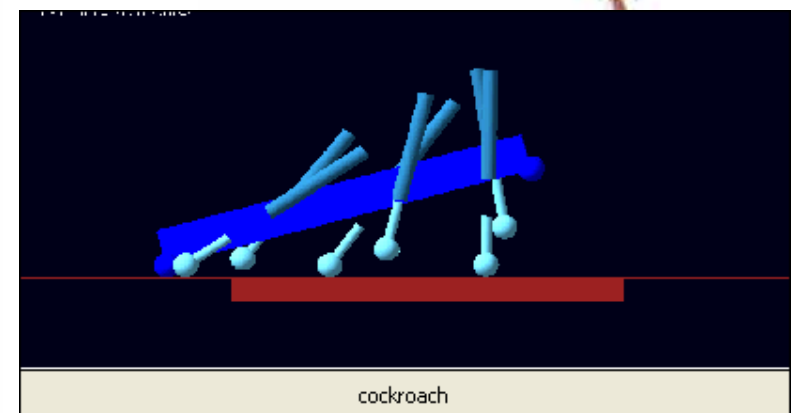
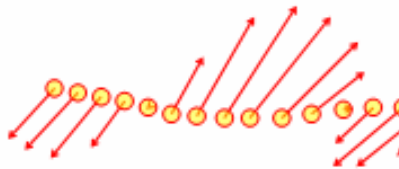
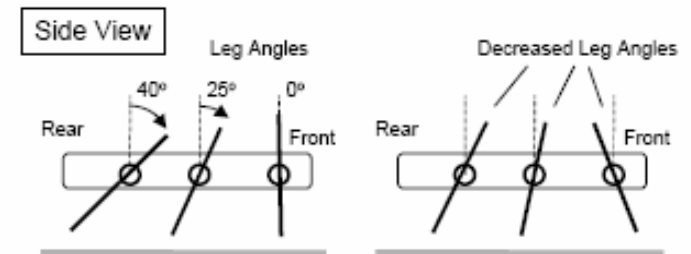

# Dynamic stability in arthropod running

Statically stable design for slower arthropod locomotion does not preclude **dynamic effects** at faster speeds.

**Duty factors** (i.e. the fraction of time a leg spends on the ground relative to the stride period) decrease to 0.5 and below as speed increases.

**Percent stability margin** (i.e. the shorter distance from the center of gravity to the boundaries of support normalized to the maximum possible stability margin) decreases with increasing speed from 60% at  $10 \text{ cm s}^{-1}$  to values less than zero at speeds faster than  $50 \text{ cm s}^{-1}$ . Negative percent stability margins indicate static instability.

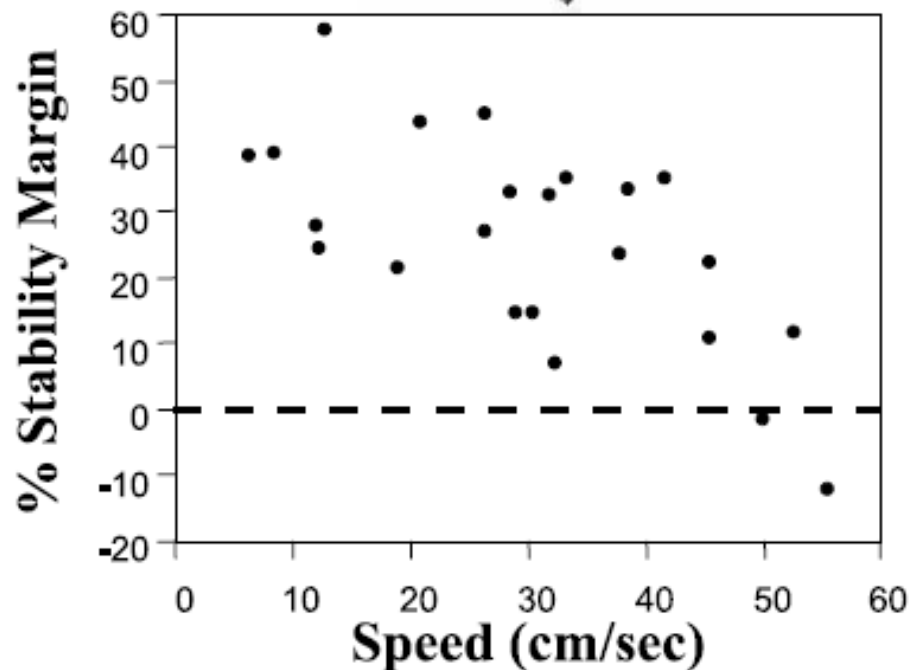
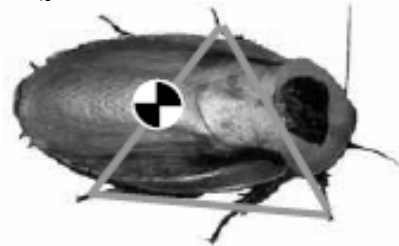

These polypedal runners remain **dynamically stable** because a force in one direction at one instant is later compensated by another force and distributed over time by the forces of inertia – the “dynamics”.



# Spring-mass dynamics of arthropod running

In faster moving cockroaches and crabs, the mass center can be modeled as a mass (i.e. the body) sitting on the top of a virtual spring (i.e. representing the legs) where the relative stiffness of all the legs acting as one virtual spring ( $k_{rel}$ ) equals

$$K_{rel} = (F_{vert}/mg)/(\Delta l/l)$$

$F_{vert}$  is the vertical ground reaction force of the virtual spring at midstance;  $\Delta l$  is the compression of the leg spring;  $l$  is the length of the uncompressed leg spring and  $mg$  is the weight.

## Leg Stiffness

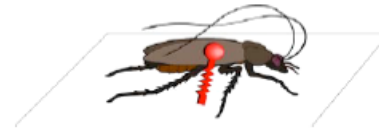
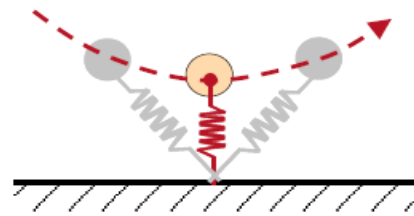

$$k_{rel} = \frac{\frac{F}{mg}}{\frac{\Delta l}{l}}$$

TROTTERS	●
RUNNERS	■
HOPPERS	▲

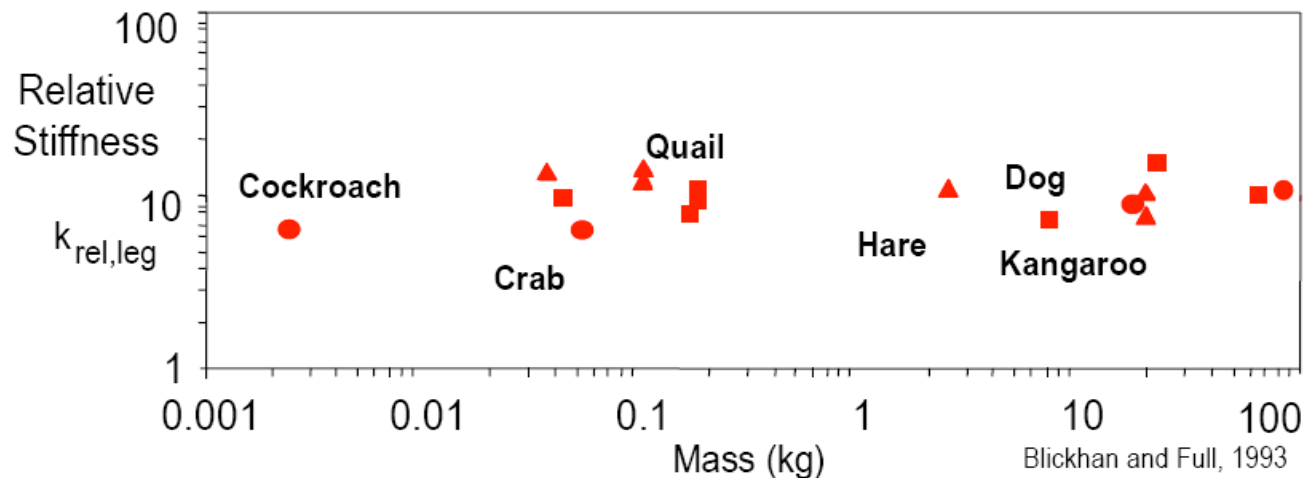

# Spring-mass dynamics of arthropod running

The **ground reaction force pattern** for six- and eight-legged arthropods is fundamentally similar to two-, and four-legged vertebrates, despite the variation in morphology. Running humans, trotting dogs, cockroaches and sideways running crabs can move their bodies by having legs work synergistically, as if they were one **pogo-stick**. **Two** legs in a trotting quadrupedal mammal, **three** legs in an insect and **four** legs in a crab can act as **one** leg does in a biped during ground contact.

## Sagittal Leg Spring

SIX- Legged

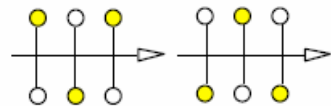

Cockroach  
Full and Tu, 1990



EIGHT- Legged

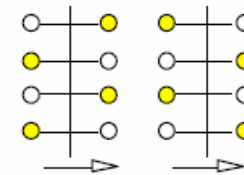

Crab  
Blickhan and Full, 1987

TWO- Legged

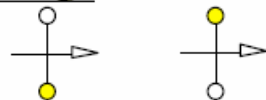

Human

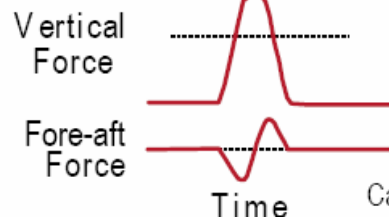
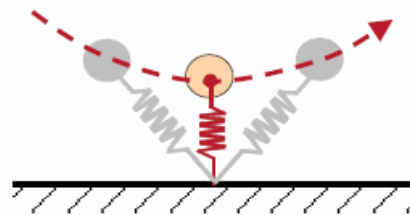

Cavagna *et al.*, 1977

FOUR- Legged

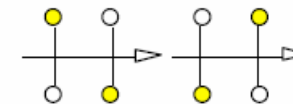

Dog

# Spring-mass dynamics of arthropod running

Spring-mass dynamics of the center of mass are not restricted to the sagittal plane. Sprawled-posture arthropod runners, such as insects, generate large lateral and opposing leg forces in the horizontal plane. As in the sagittal plane, the three legs of the tripod appear to function synergistically as if they were one virtual, lateral leg spring (**Schmitt and Holmes**, 2000a, 2001). **Kubow and Full** (1999) suggest a further advantage to an appropriately sprawled posture with large forces along the horizontal plane. Their studies suggest that horizontal perturbations to a steady running cycle are rejected by the resulting changes in the body's position relative to the location of the feet.

## *Different View of Stability*

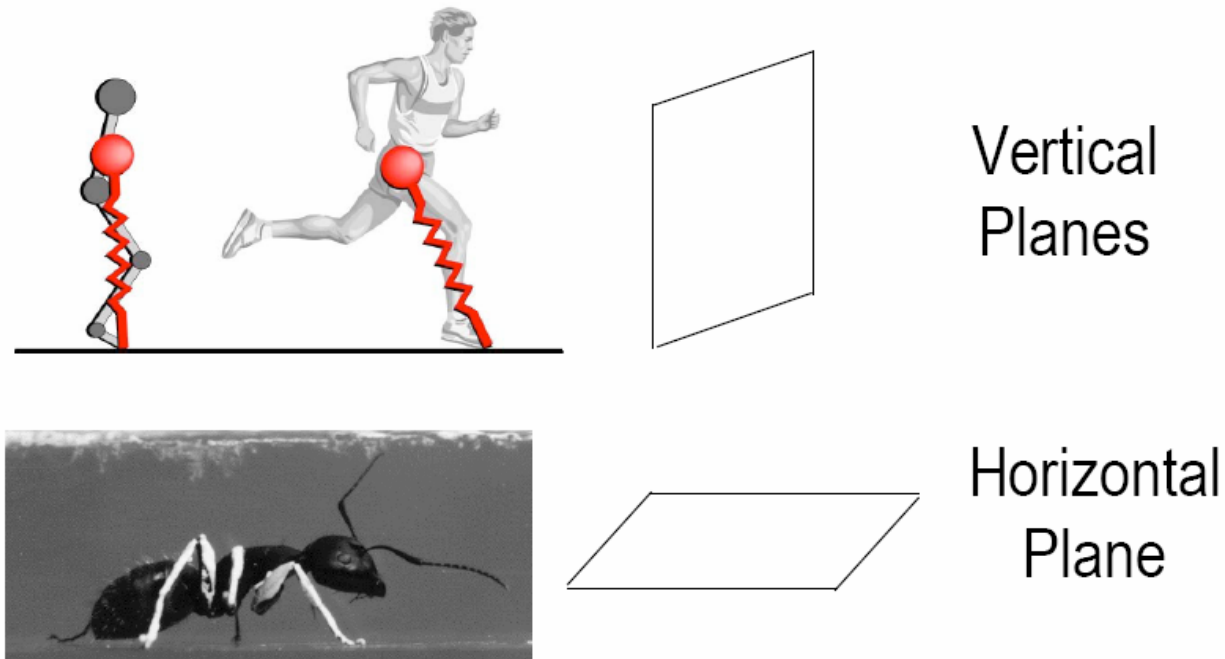

# 3. Passive Visco-elastic Structure (I)

Studies of the cockroach *Blaberus discoidalis* are revealing the role of the viscoelastic properties of its muscles and exoskeleton in locomotion (Garcia et al., 2000; Meijer and Full, 2000; Xu et al., 2000).

- Exoskeleton and muscle properties
- Compliance
- Damping

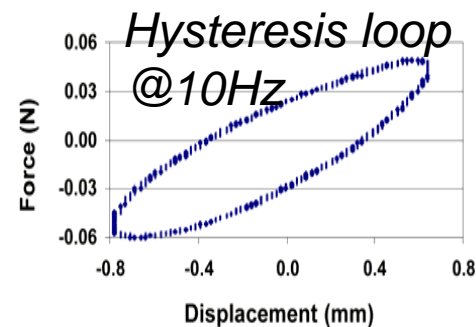
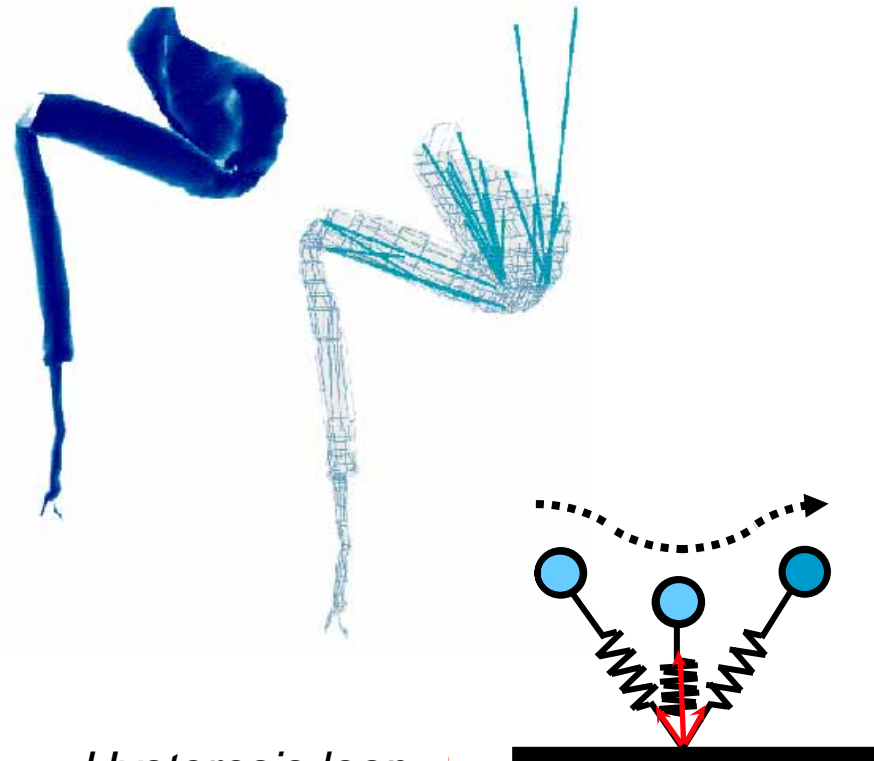

### 3. Passive Visco-elastic Structure (II)

The prototype's leg design contains a passive compliant and damped rotary hip joint fabricated as a flexure of soft viscoelastic polymer urethane embedded in a leg structure of stiffer plastic.

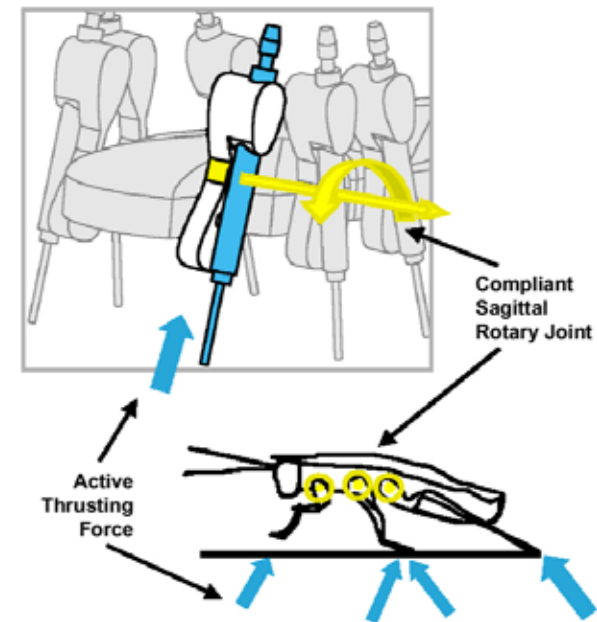
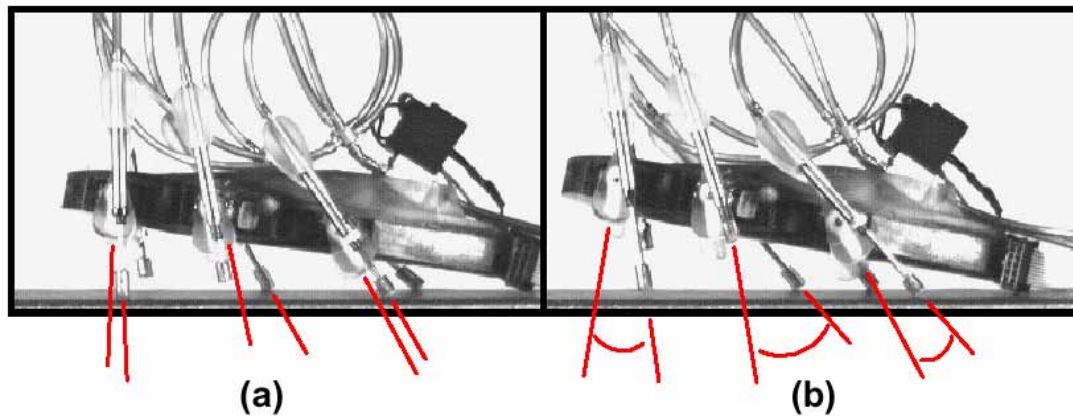

*High-speed footage of the running robot in a) mid-stance and b) full extension. As shown, the compliance in the leg plays an important role in the locomotion, as evidenced by the large deflections during the stride.*

## 4. Open-loop/Feed-forward Control (I)

**Preflexes:** *The self-stabilizing properties of the visco-elastic mechanical system provide an immediate, or “zero-order” response to perturbations without the delays of neural reflexes*

- Passive properties of the mechanical system...
- ...that stabilize and reject disturbances
- Immediate response
- No delays associated with sense-compute-command loops

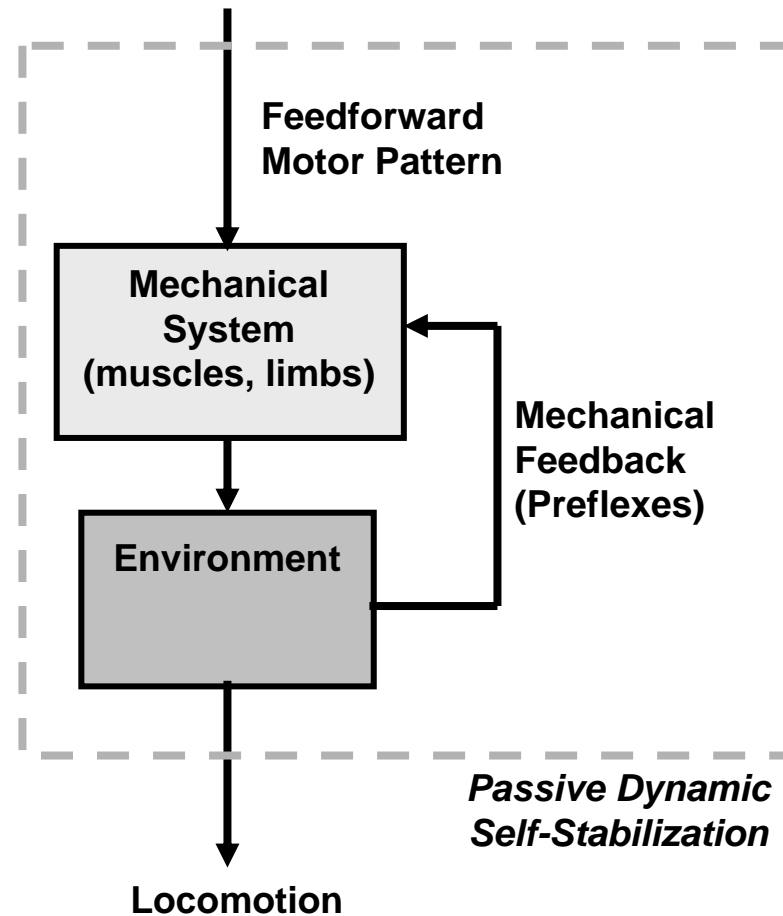

# *Biological Inspiration*

- When transitioning from flat to rough terrain...
- ...impulses sent to the muscles did not noticeably change
- Similar activation despite large changes in events

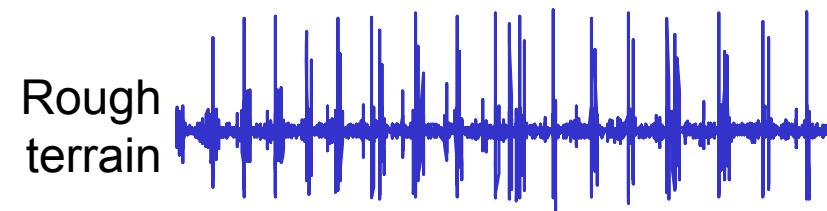
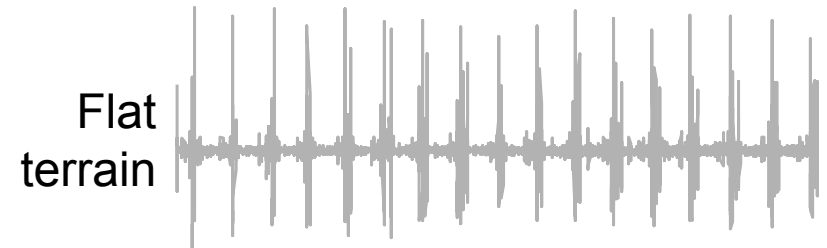

# *Biological Inspiration*

- Implies exclusion of sensory feedback
- No precise foot-placement or “follow-the-leader gait”
- But still able to traverse rough terrain..!





# Control Hierarchy

- **Preflexes** provide immediate stabilization for repetitive task
- **Reflexes** and neural feedback adapt to changing conditions...
- ...through the feedforward pattern

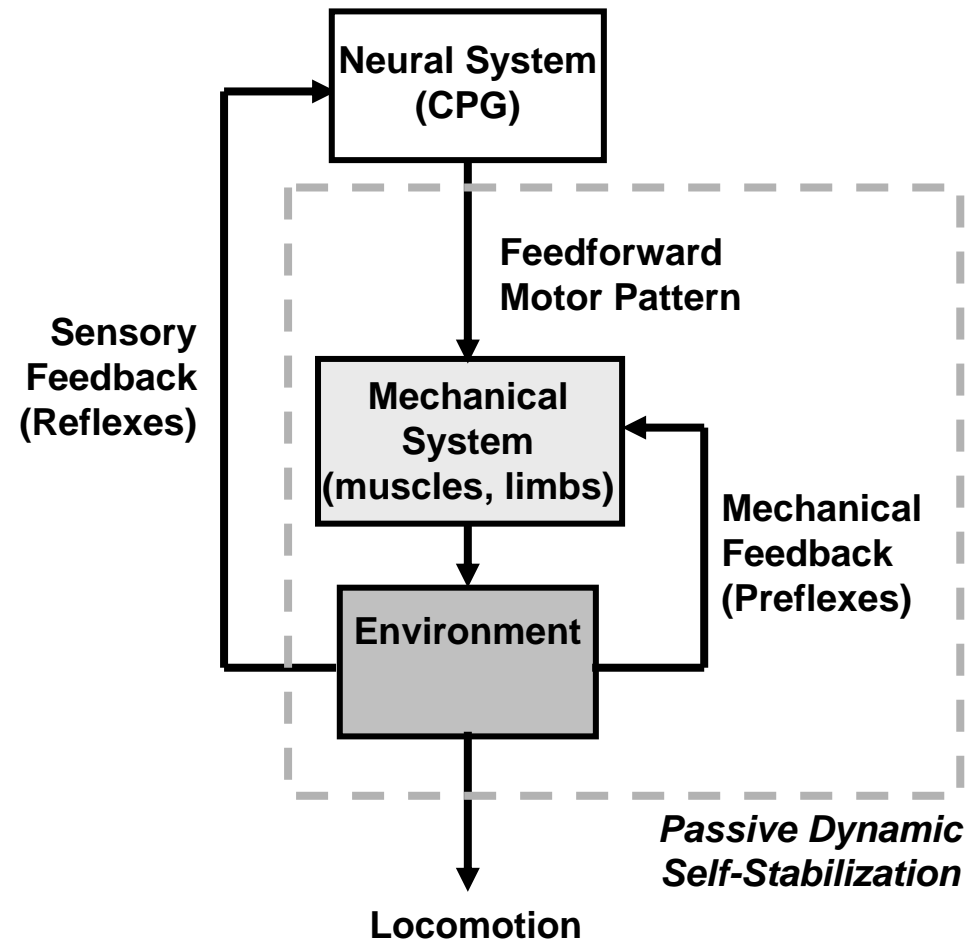

# 4. Open-loop/Feed-forward Control (II)

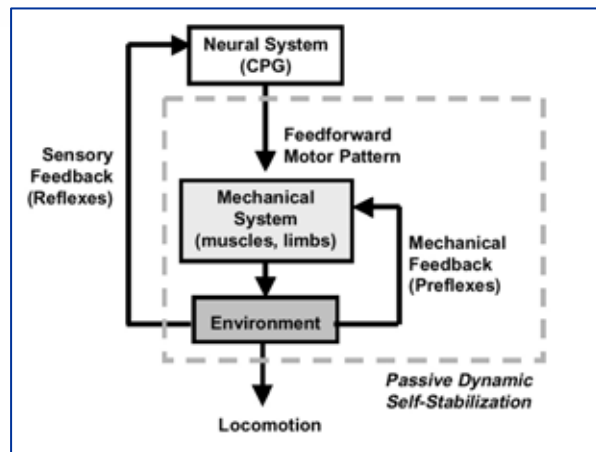
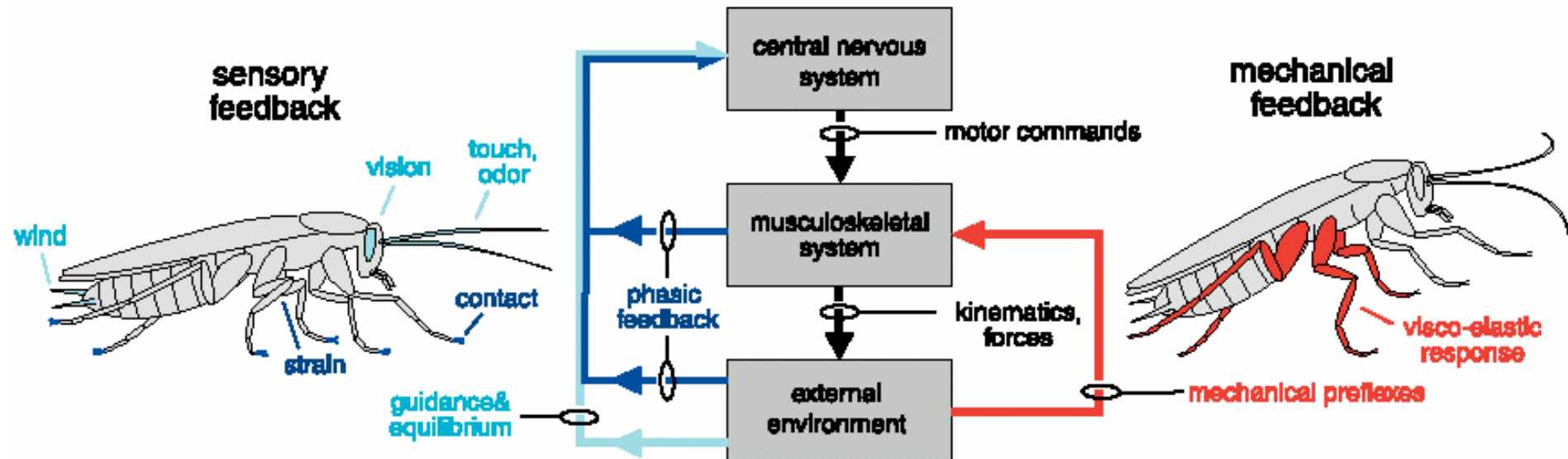

<u>Mechanical System</u>	<u>Neural System</u>
<u>Feedforward</u>	<u>Reflex</u>
Motor program acting through moment arms	Intrinsic musculo-skeletal properties
Predictive	Rapid acting
<b>Passive Dynamic Self-stabilization</b>	<b>Active Stabilization</b>

Both neural and mechanical feedback play roles in controlling locomotion

*M.H. Dickinson et al., How Animals Move: An Integrative View, SCIENCE, vol 288 (2000)*

## 4. Open-loop/Feed-forward Control (III)

Each of the tripods is pressurized by a separate 3-way valve, which connects the pistons to either a pressurized reservoir or the atmosphere.

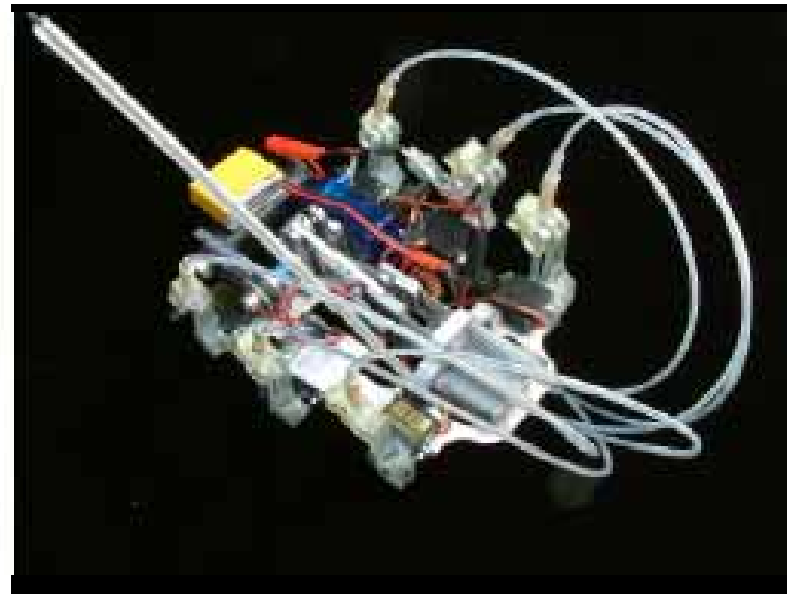
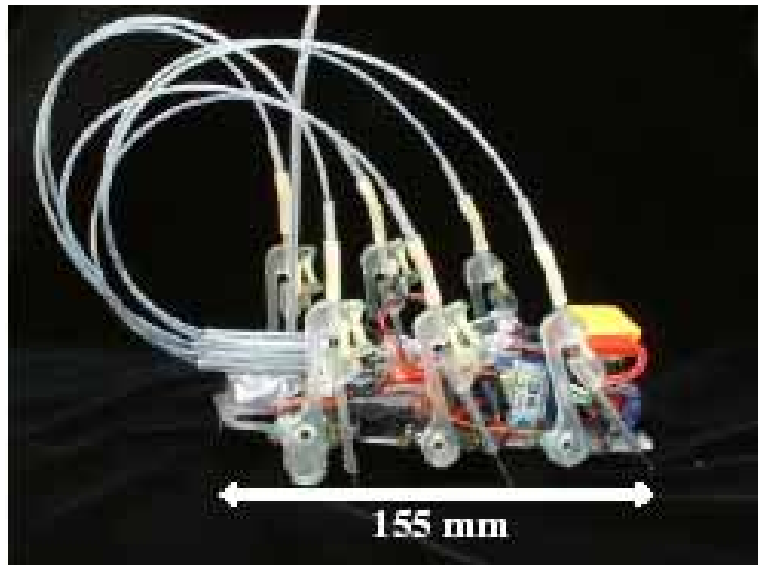

**i-Sprawl:** a fully **autonomous** hexapedal robot driven by an **electric motor** (**lithium polymer batteries**) and flexible push-pull cables (autonomous version of sprawl robot)

**Velocity of the *iSprawl* robot = 15 body-lengths/second (2.3 m/s)**

**Weight = 0.3 Kg**

# *iSprawl*: Autonomous Open-Loop Running

In the case of the Sprawl family of robots, the main principles adapted from insects, the cockroach in particular, are:

- a **sprawled** posture, with a wide stance and rear legs directed backward;
- a bouncing, alternating **tripod gait** based on an open-loop motor pattern;
- **specialization** in which the rear legs primarily accelerate the robot while the front legs decelerate it;
- a **single active degree of freedom** per leg, in which thrusting is directed along the axis of the leg;
- **passive “hip” joints** that swing the legs forward between steps;
- **compliance** and **damping** that absorb perturbations.

# Sprawl robot series

**Sprawl**

**Sprawlita**

**MiniSprawl**

**Sprawlette**

**i-Sprawl**

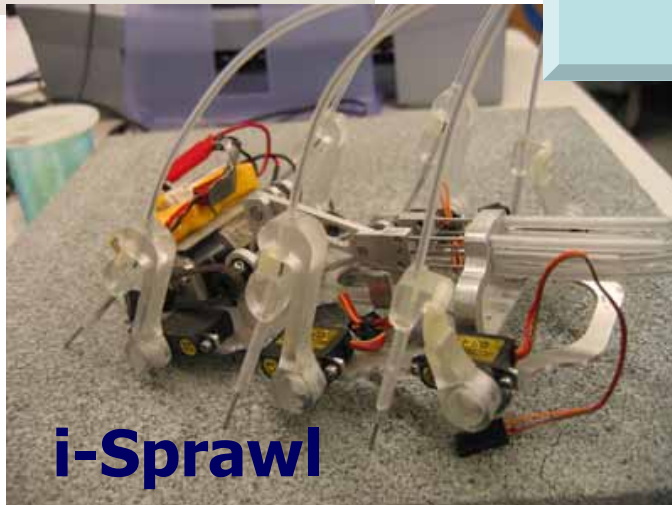
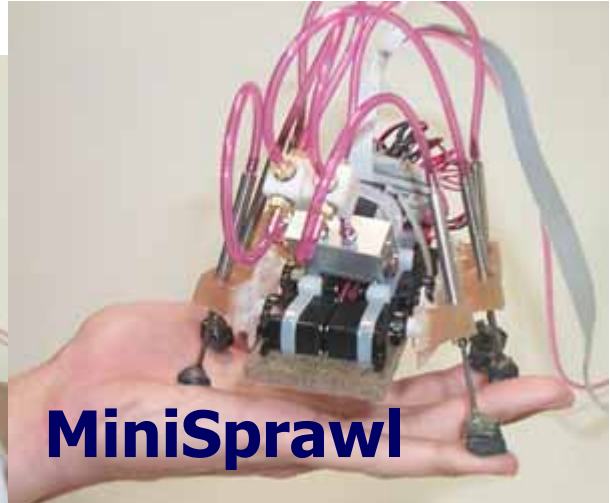
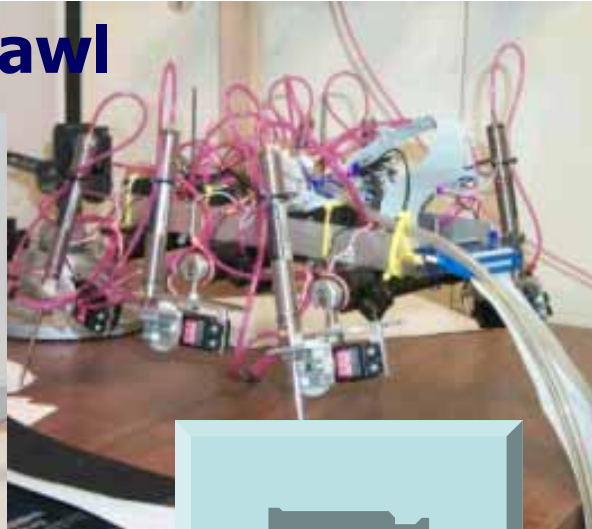
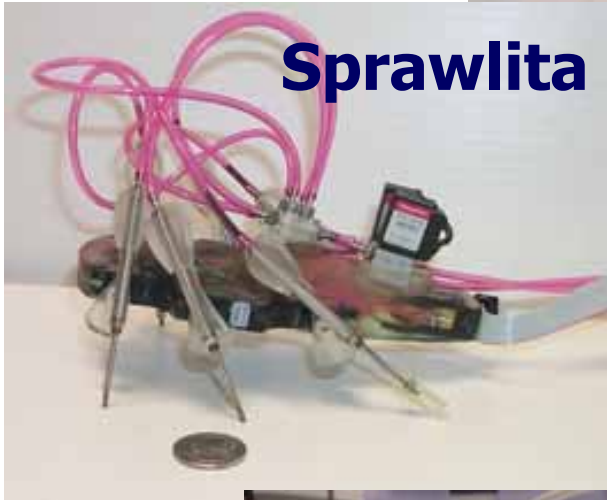
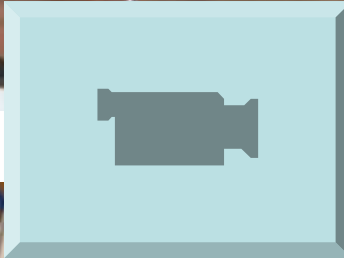

# Another approach to the problem: The CWRU's Robot serie



*Roger Quinn  
Case Western  
Reserve University*



*Roy Ritzmann  
Case Western  
Reserve University*

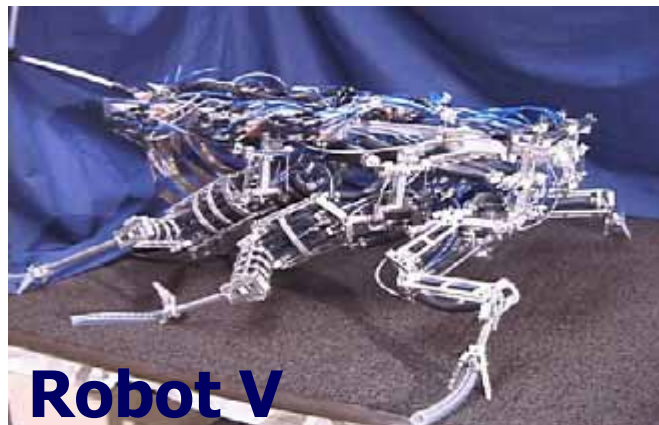

**Robot V**

# Another approach to the problem: The CWRU's Robot serie

**Robot V** is a hexapod with kinematics based on studies of the cockroach *Blaberus discoidalis* performed in the **Ritzmann Lab in the Biology Department at CWRU**. It has a total of **24 degrees of freedom**:

- **five for each front leg,**
- **four for the middle legs**
- **three for the rear legs.**

The robot is pneumatically actuated using off the shelf cylinders and blocks of **three-way pneumatic valves**. Weight of the robot = 15 Kg.

**Robot V** followed the biology as default strategy and was based **as closely as possible on the structure and walking strategies** that were observed in the death head cockroach *Blaberus discoidalis* (Watson and Ritzmann, 1998, Bachmann, 2000, Watson et al. 2002).



**Robot V** has in the **front legs three joints** between the body and coxa ( $\gamma$ ,  $\beta$  and  $\alpha$ ). The **two** remaining joints are between the **coxa and femur** and the **femur and tibia**.

On **Robot V**, the **middle legs** have only **two degrees of freedom— $\alpha$  and  $\beta$** —between the body and coxa, and retain the **single joint** between the **coxa and femur** and the **femur and tibia**.

Finally, the **rear legs** of the **robot** have **only one** joint between each of the segments. The body-coxa joint uses of only the  **$\beta$  joint**.

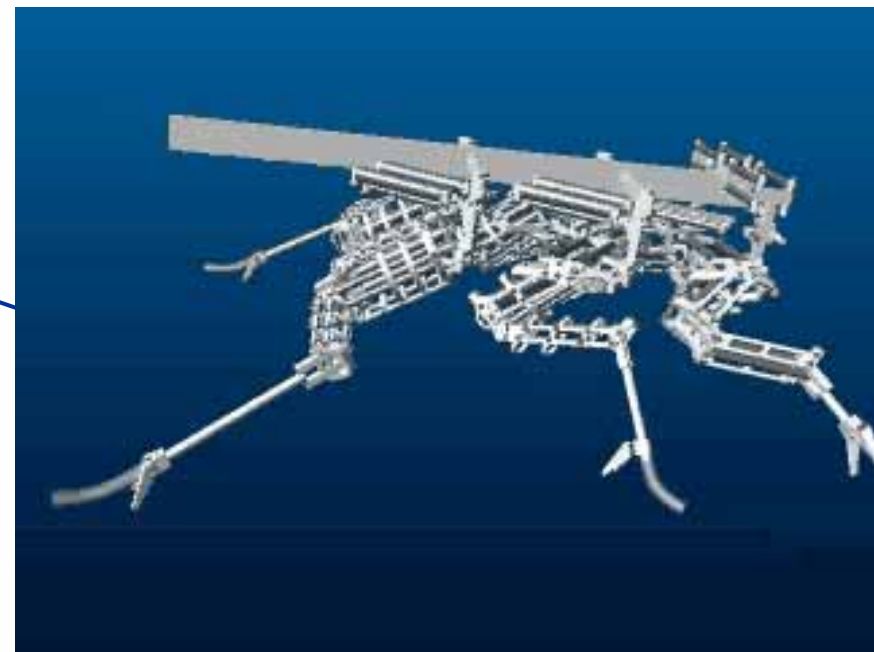
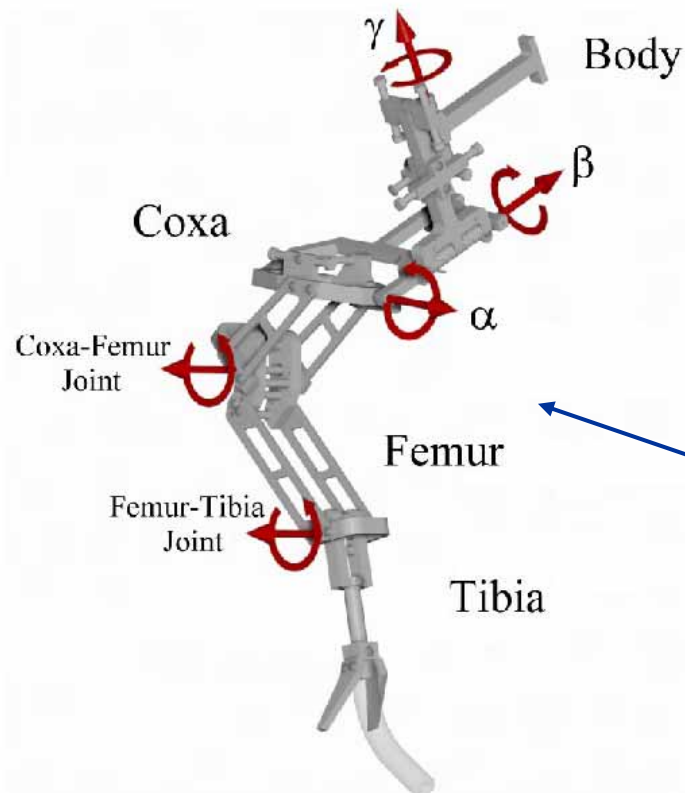



# CWRU's Robot serie

**Robot I**

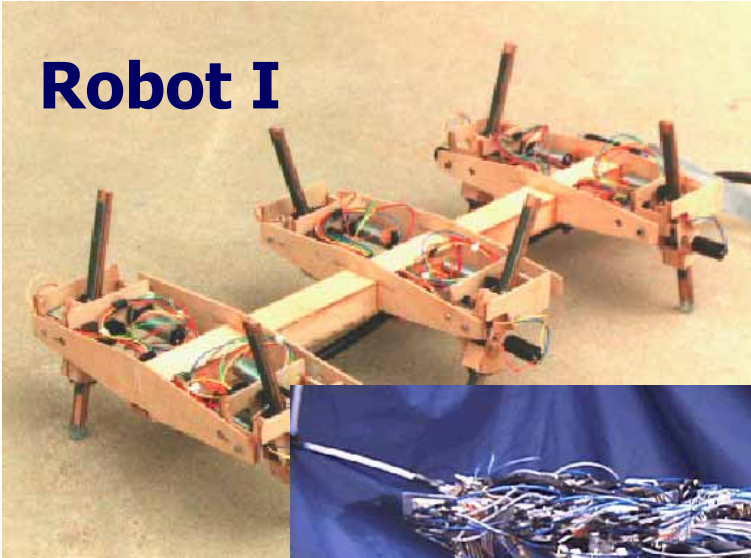

**Robot II**

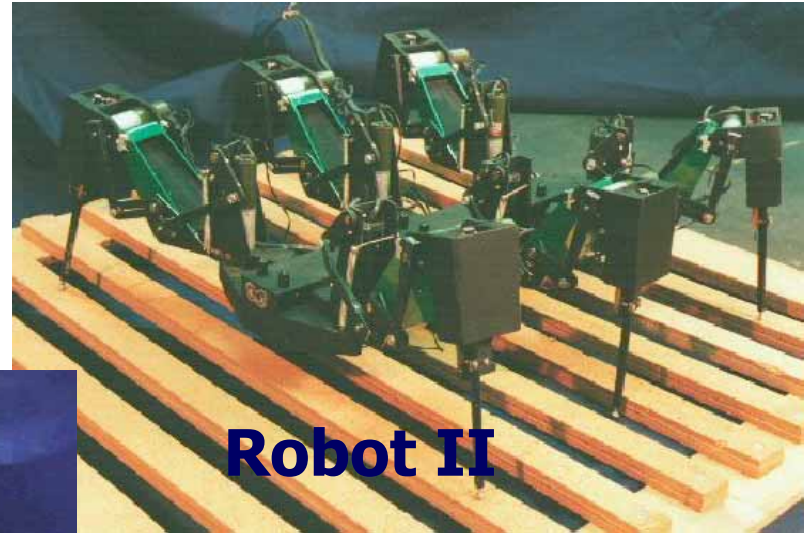

**Robot V**

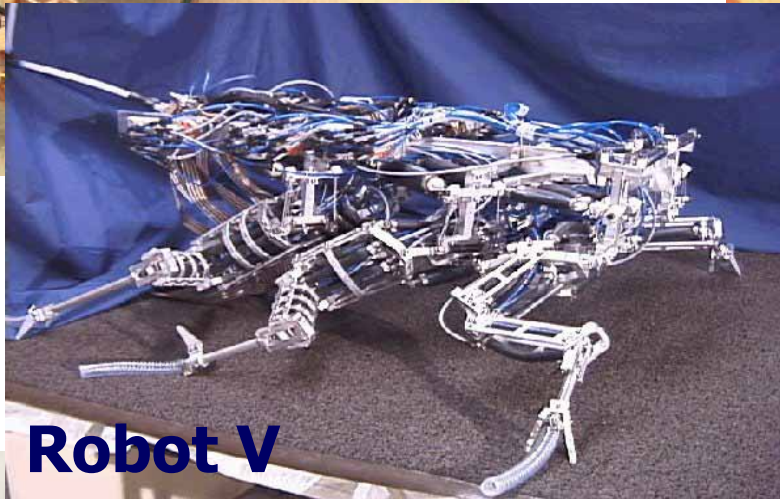

**Robot III**

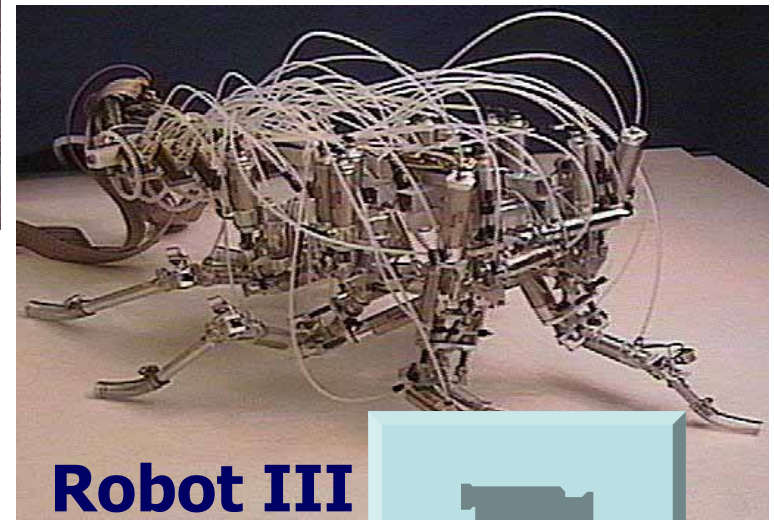

**Robot IV**

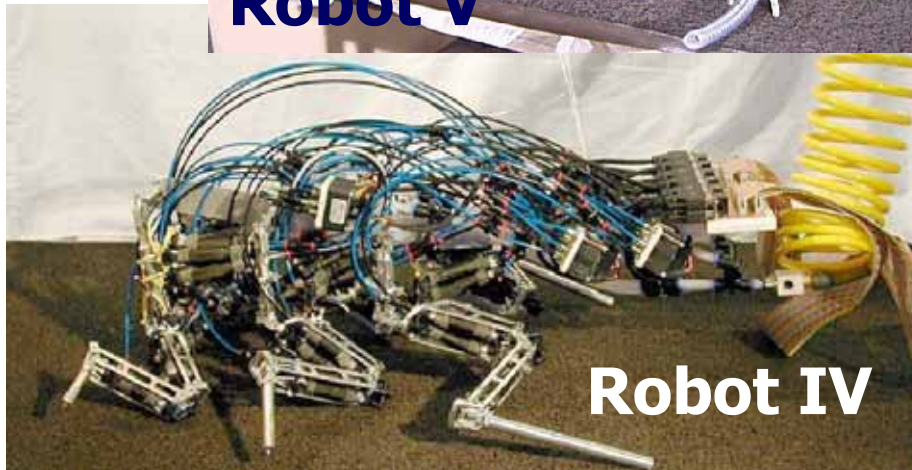

# Control of obstacle climbing in the cockroach, *Blaberus discoidalis*

Case Western Reserve University –  
Roger Quinn (engineer) – Roy Ritzmann (biologist)

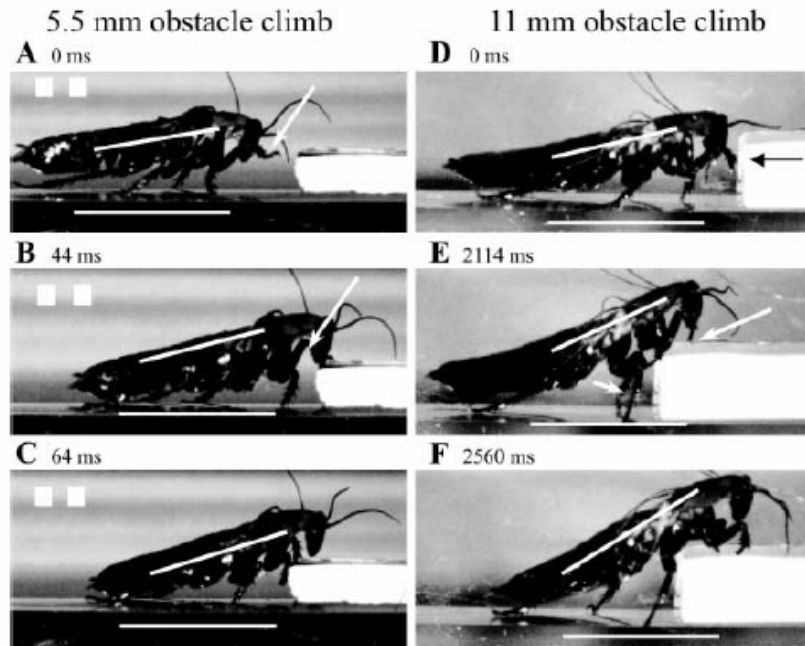
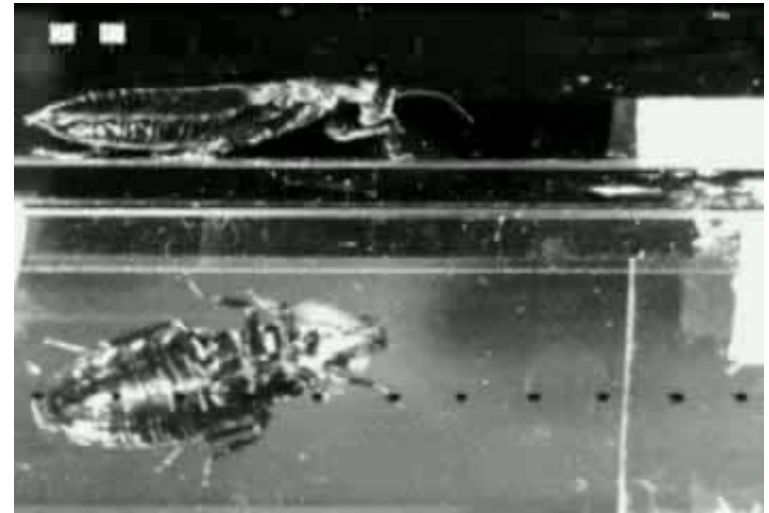

An insect that encounters an obstacle as it is walking could do one of the three things:

1. It could climb over the obstacle by making **little or no modifications of the tripod gait**.
2. It could **change to a completely** different set of leg movements.
3. It could use normal walking movements, coupled with **postural adjustments** to direct the movement of its body over the obstacle.

During horizontal running, the tarsi of the front legs are normally lifted higher than 6 mm. Therefore, when the cockroach approaches a **5.5 mm block**, the front legs require no alteration in swing trajectory to reach the top of the obstacle. However, for **11-mm obstacles** the front tarsus would encounter the vertical surface of the barrier well below the top. The body angle increases *before* the tarsus of the front leg touches the top of the 11-mm obstacles, because of the middle leg extension. Then, the front leg contacts the top of the block.

# Whegs Robot (CWRU)

The Whegs™ series robots utilize a method of locomotion that combines the advantages of **wheels and legs** (wheel-legs). Wheels are relatively simple, and allow a vehicle to move over terrain quickly. Legs allow robots to climb obstacles that are higher than what a wheeled vehicle would be able to climb over.

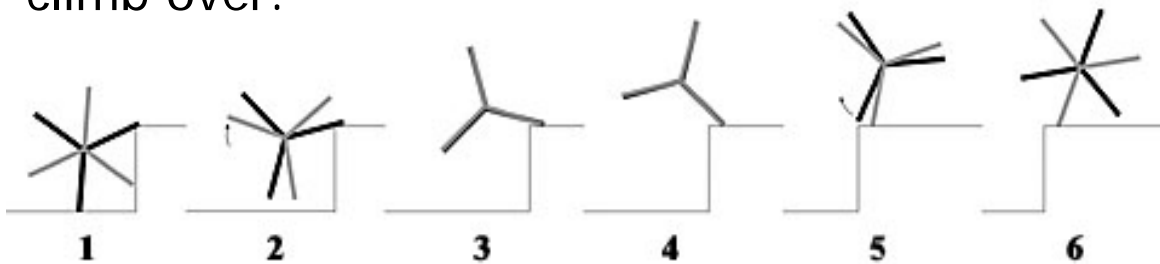

## Bio-inspired working principle:

1. Locomotion
  - tripod gait
2. Climbing of obstacles
  - modification of leg's movements
  - postural adjustment (body flexure)

**III PARTE**  
**Bioinspired Climbing**  
**Robots**

# Topic - *Problem definition*

Scansorial Agility requires solutions that accommodate a *variety of surfaces*, which vary from hard to soft and from rough to smooth.

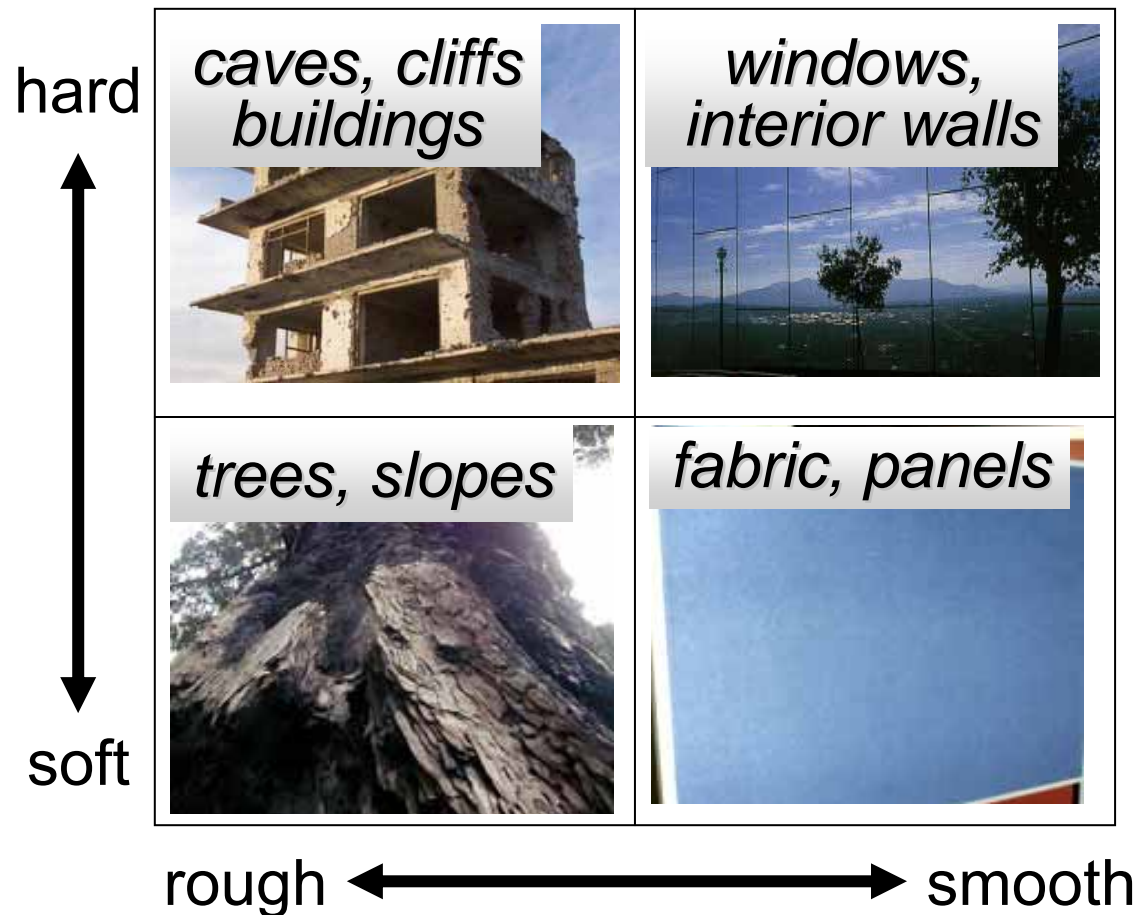

# Scansorial Surfaces

which solutions excel on each surface type?

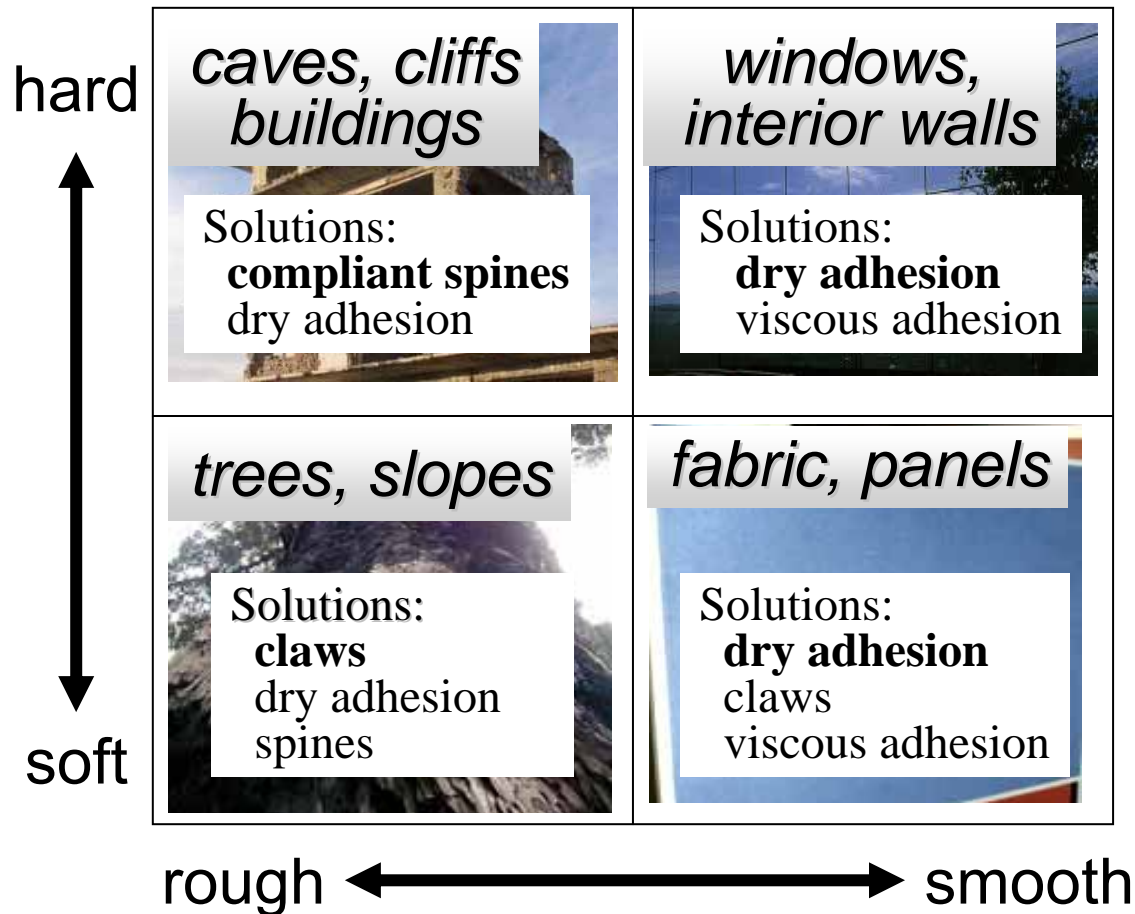

# Bioinspiration - how do they do it?



**insect: spines, adhesive pads and distal claws**



**tree frog: toes, viscous adhesion**



**spider: spines, scopulae**



**gecko: setae, lamellae, claws**



**squirrel: toes, claws**

Creatures that exemplify “**scansorial agility**” always use multiple solutions.

# Biology - examine literature, work with biologists

e.g. Gecko hierarchical adhesion structures

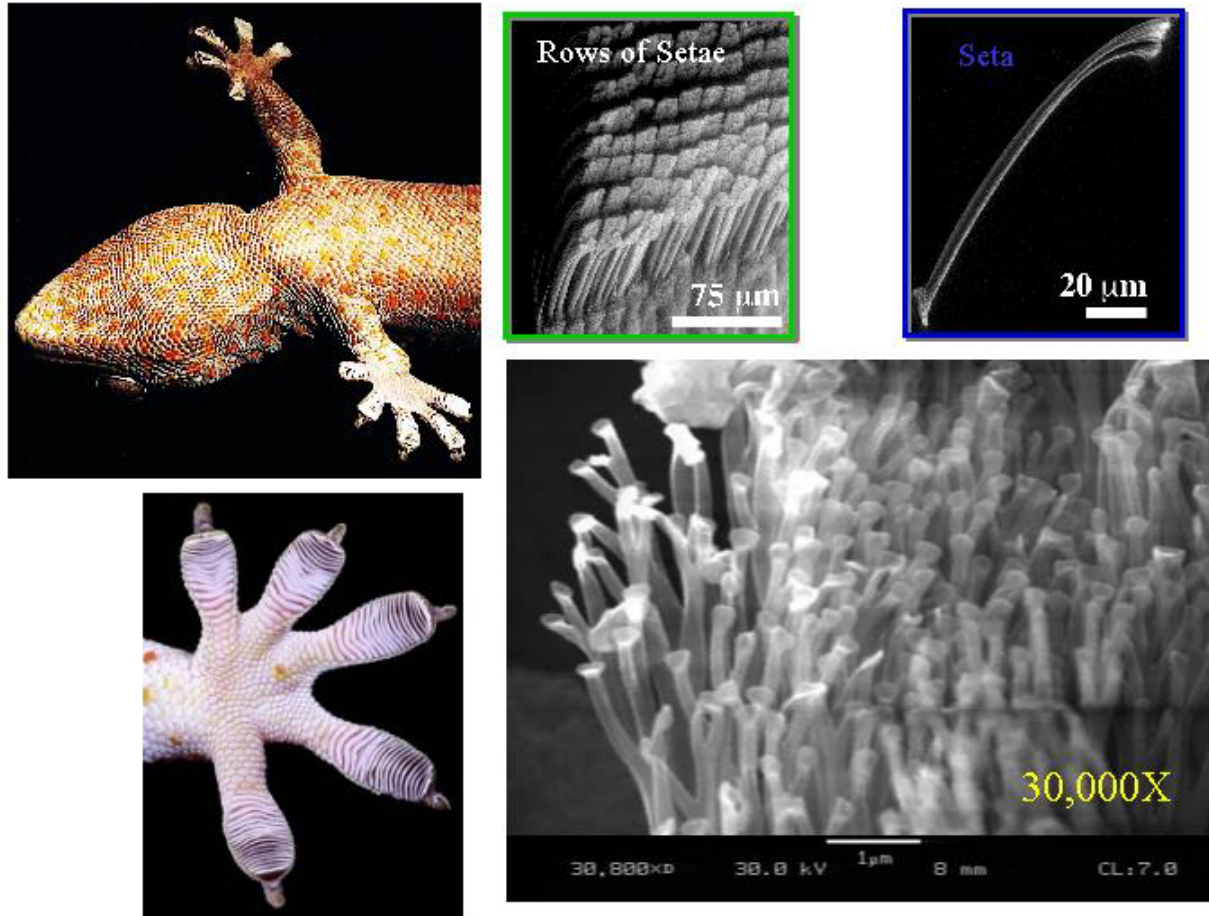

[Autumn et al. 2002 *PNAS*]



## **Hypotheses** - regarding the principles at work

- What is dry adhesion?
  - What are the physical principles?
  - What rules must be followed for good results?
- How do geckos use dry adhesion?
  - What structures do they have?
  - What control do they exert?
- How can we create dry adhesive structures?
- How can we use dry adhesion in a climbing robot?

# Hypotheses - regarding the principles at work

- Foot = 5 fingers
- The bottom surfaces of toes are covered with **lamellae** (millimeter scale)
- **Lamellae** are composed of many individual **setae** (1-50 micrometer scale)
- The tips of the setae are divided into hundreds of **spatulae** (<500 nm scale)

## Tour of a Gecko Foot

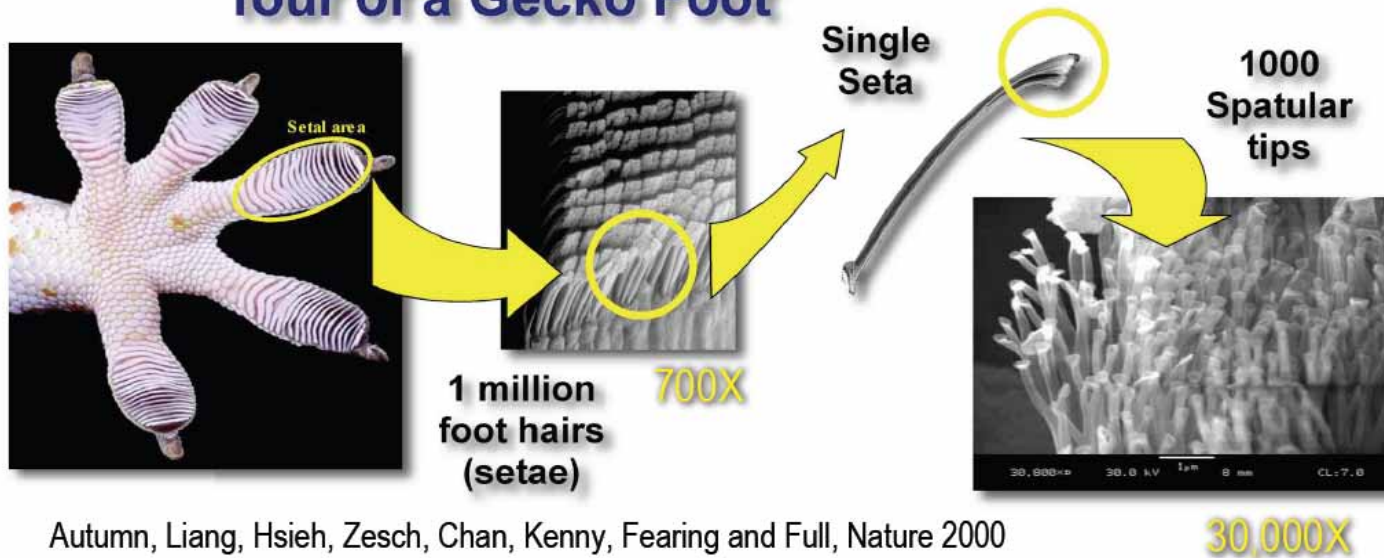

The consequence of the gecko's hierarchical system of compliances is that it can achieve **levels of adhesion** of over **500 KPa** on a wide variety of surfaces from glass to rough rock and can support its entire weight from just one toe.

# Requirements for climbing with dry adhesion

- **Hierarchical compliance** over scales from  $10^{-2}$  to  $10^{-7}$ m.

**Reason:** obtain large contact areas and uniform loading on materials ranging from glass to bark.

**Consequence:** need compliances at limb, toe, lamellar and setal scales; need integrated macro/micro fabrication solutions.

- **Anisotropic adhesion and friction**

**Reason:** control adhesive stresses and attachment/detachment.

**Consequence:** need asymmetric, fully 3D micro structures that are difficult to fabricate with current MEMS and nanofabrication technologies

- **Distributed Control of Forces**

**Reason:** increase stability, prevent contact stress concentrations **Consequence:** need heterogeneous and anisotropic structures behind the contact surface for shear load transfer; need compliant under-actuated mechanisms and feedback for internal force control.

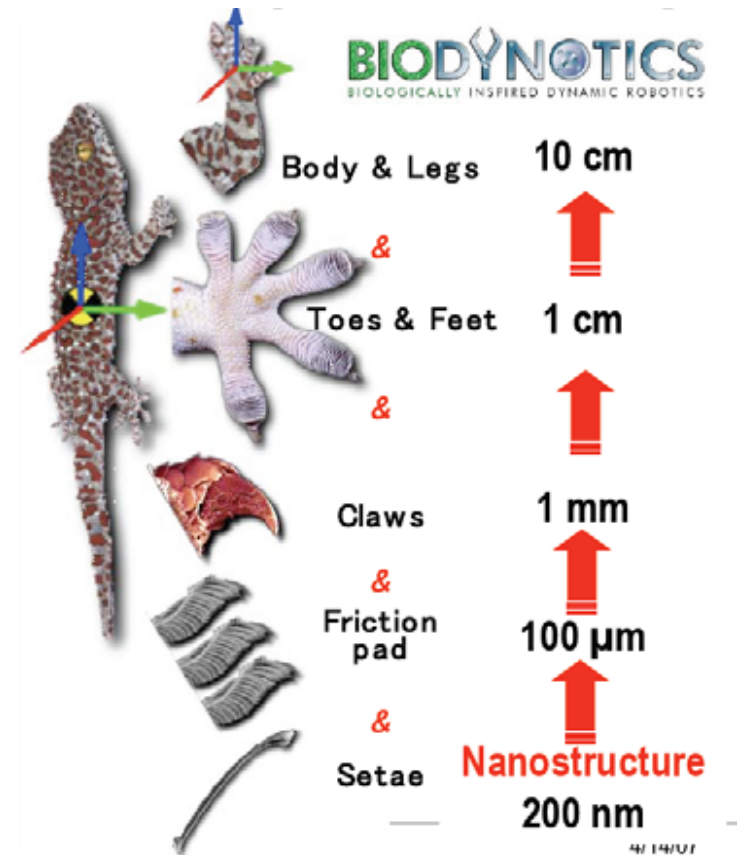

[S. Kim et al 2006]

# StickyBot Design



<http://bdml.stanford.edu/twiki/bin/view/Main/StickyBot>

# Robotics - Implementations of principles

## StickyBot

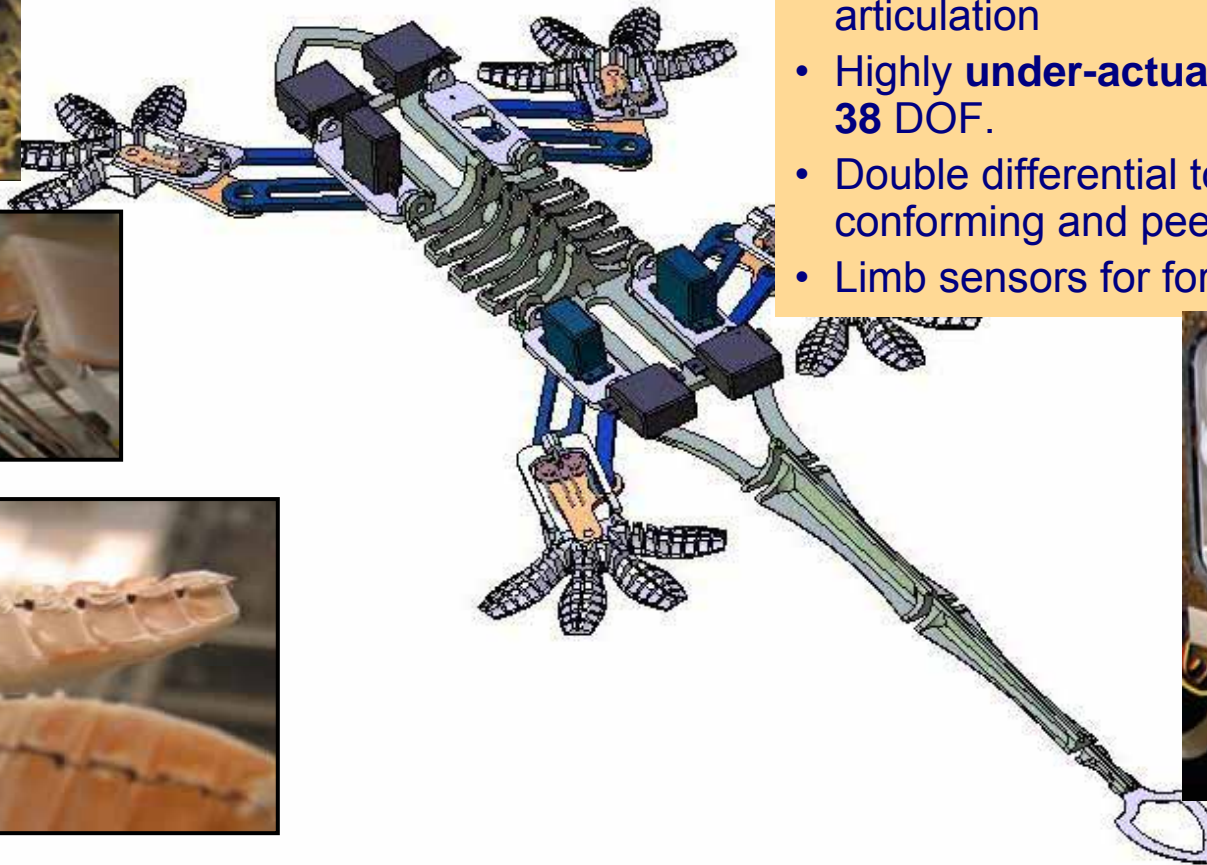
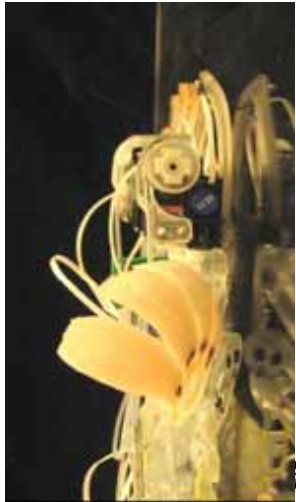

- The torso and limbs are created via **Shape Deposition Manufacturing** using two different grades of polyurethane
- Torso and forelimbs are reinforced with **carbon fiber**
- The **spine structure** at the center of body has the ability to provide body articulation
- Highly **under-actuated**: **12 servos**, **38 DOF**.
- Double differential toe mechanism for conforming and peeling
- Limb sensors for force control.

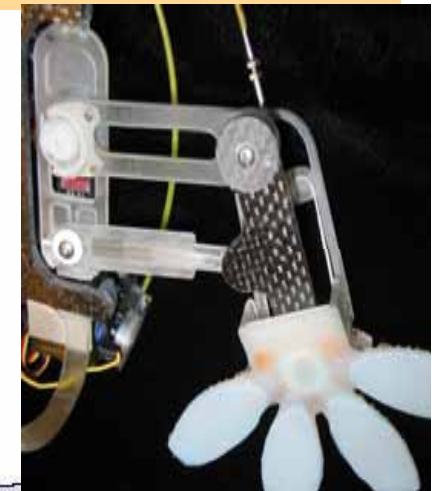

# Hierarchical and anisotropic compliance

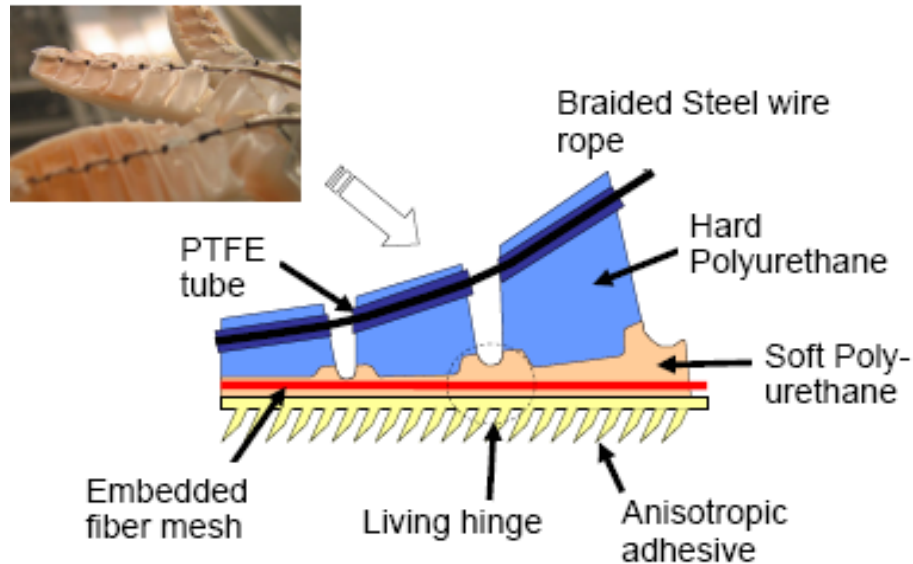

At the finest scale, the contact surfaces of the feet are equipped with **synthetic adhesive materials**. To date, the best results have been obtained with arrays of small, asymmetric elastomeric features. The arrays are made by micromolding with a soft (Shore 20-A) urethane polymer. This structure allows **anisotropic compliance** that is essential for the **directional adhesive behavior**.

The adhesion only occurs if the lamellae and setae are loaded in the proper direction.

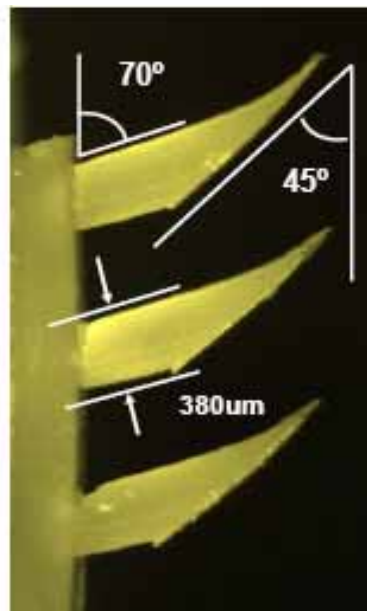
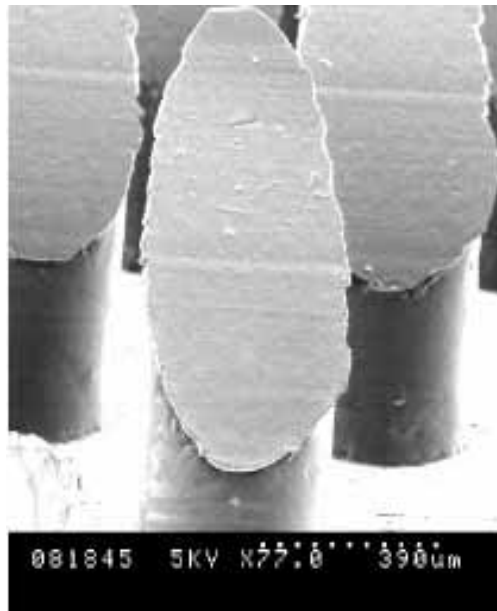

# Anisotropic adhesion and friction

Fabrication of anisotropic adhesive pads for StickyBot

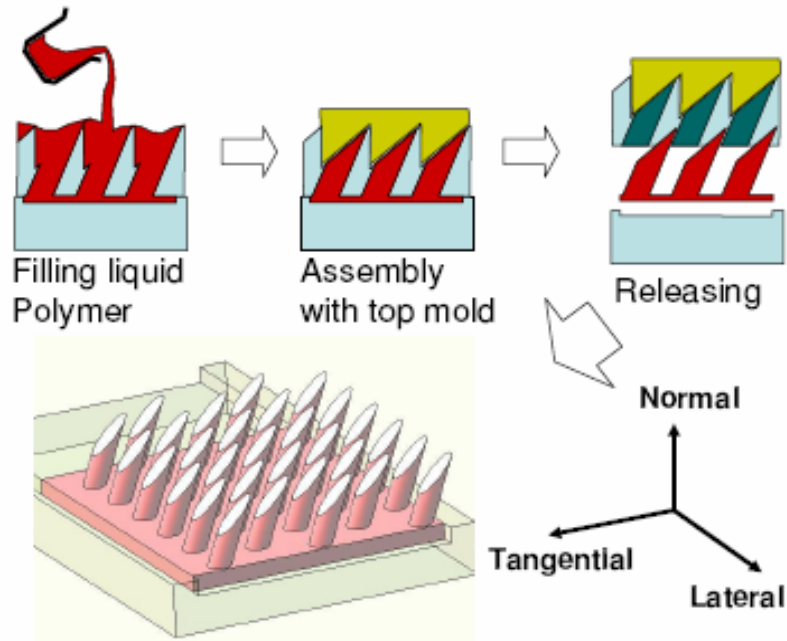

Fabricated anisotropic stalks oriented at  $20^\circ$  with stalk faces oriented at  $45^\circ$ , both with respect to normal.

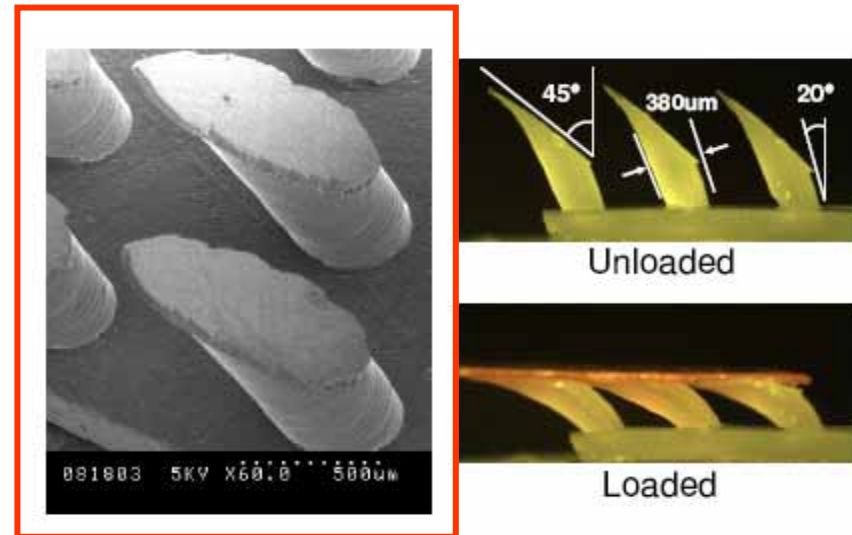

Molding process used to fabricate anisotropic patches.

[D. Santos et al 2006]

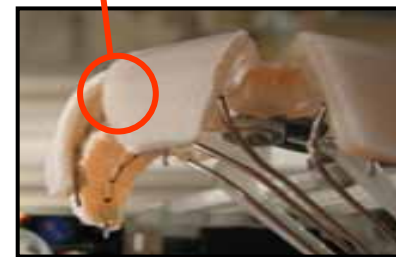

# Anisotropic adhesion and friction

Gecko setae dragging with curvature

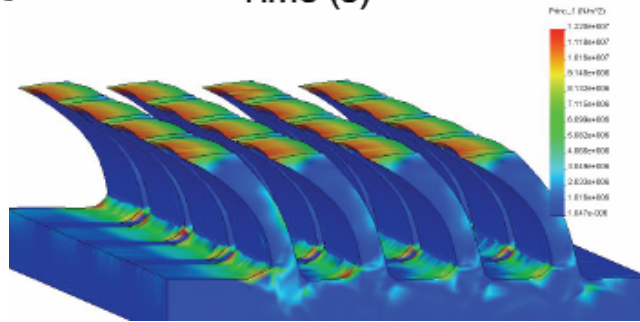
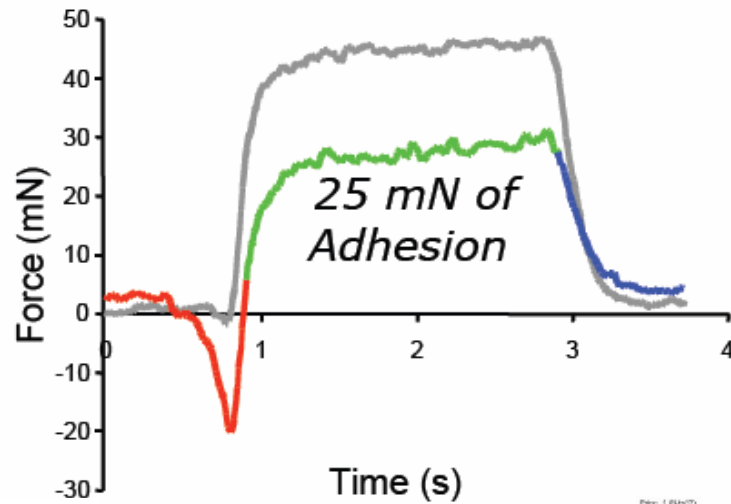
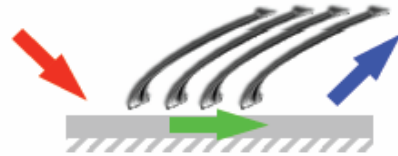

Dragging against curvature

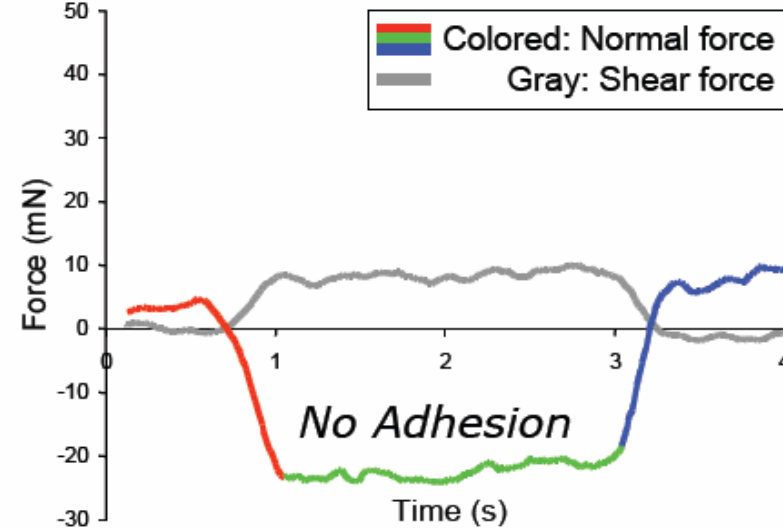
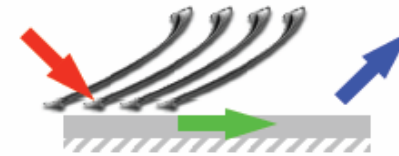

Synthetic elastomer  $\mu$ -combs:  
optimize geometry for directional  
adhesion and uniform tip stress.





# Hierarchical compliance

To enable Stickybot to climb a variety of surfaces a hierarchy of compliances has been employed. The body of Stickybot is a highly compliant under-actuated system comprised of 12 servos and 38 degrees of freedom (Used SDM-Shape Deposition Manufacturing).

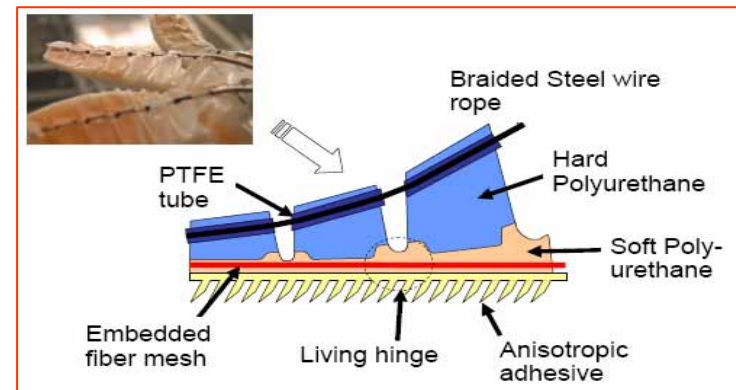
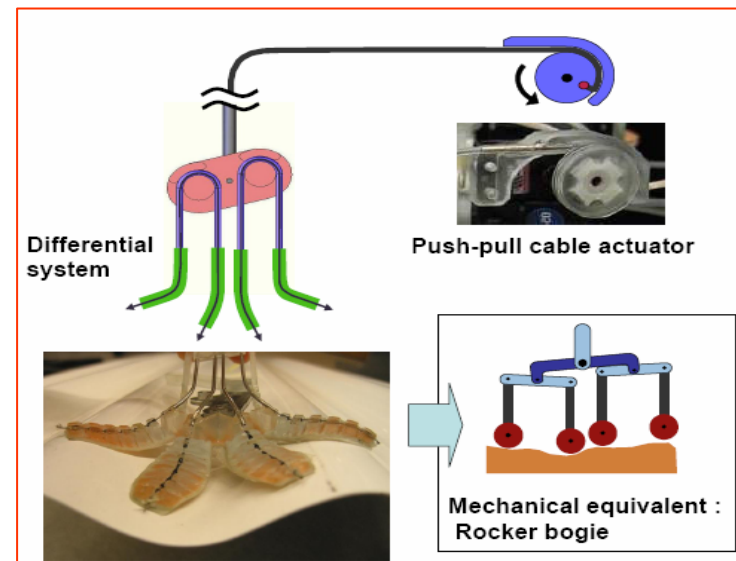
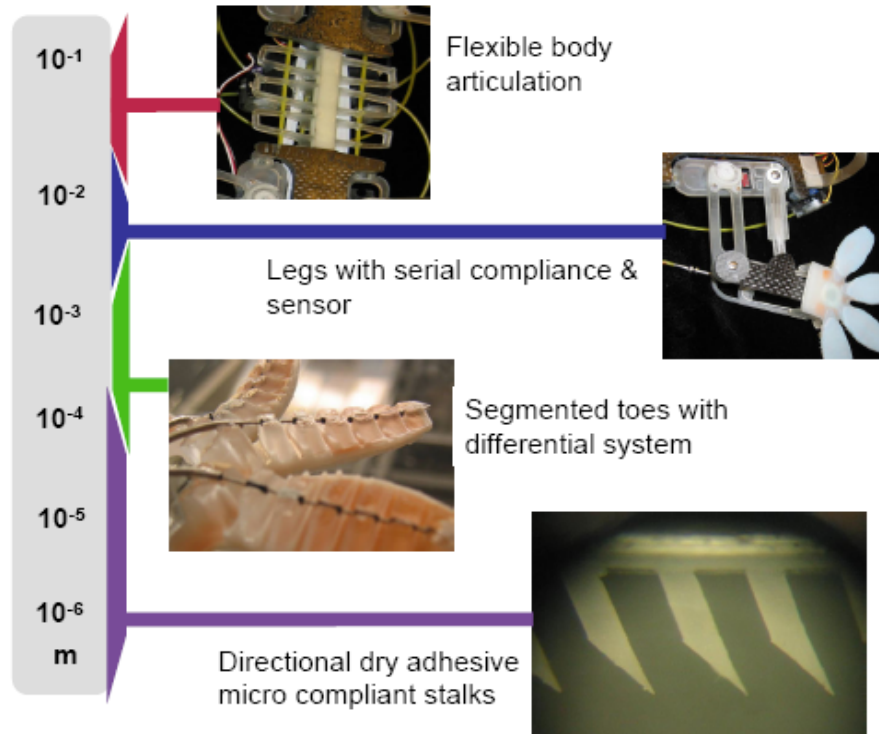

[S. Kim et al 2006]

# Anisotropic adhesion and friction

**Main challenge to robust climbing is not more adhesion but controllable adhesion.** Sticky tape is sufficiently adhesive for a lightweight climbing robot, but its adhesive forces are difficult to control. Geckos control their adhesion with anisotropic microstructures, consisting of arrays of setal stalks with spatular tips [Autumn et al. 2006].

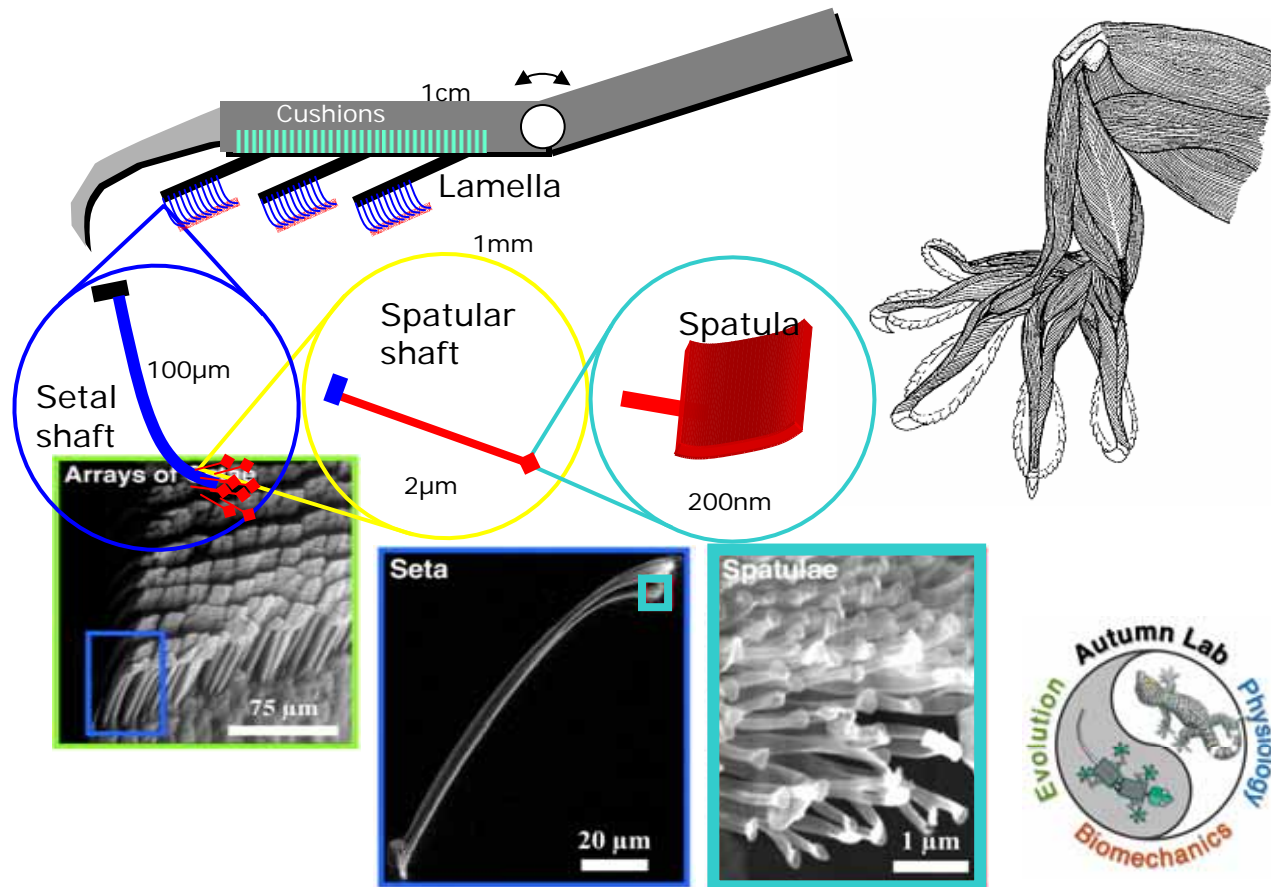

# Distributed Control of Forces

Distributed force control ensures that stresses are uniformly distributed over the toes and that undesirable force transients are avoided.

In StickyBot, directional adhesion are used to minimize detachment forces. To achieve smooth engagement and disengagement and control its internal forces, **StickyBot uses force feedback coupled with a stiffness controller.**

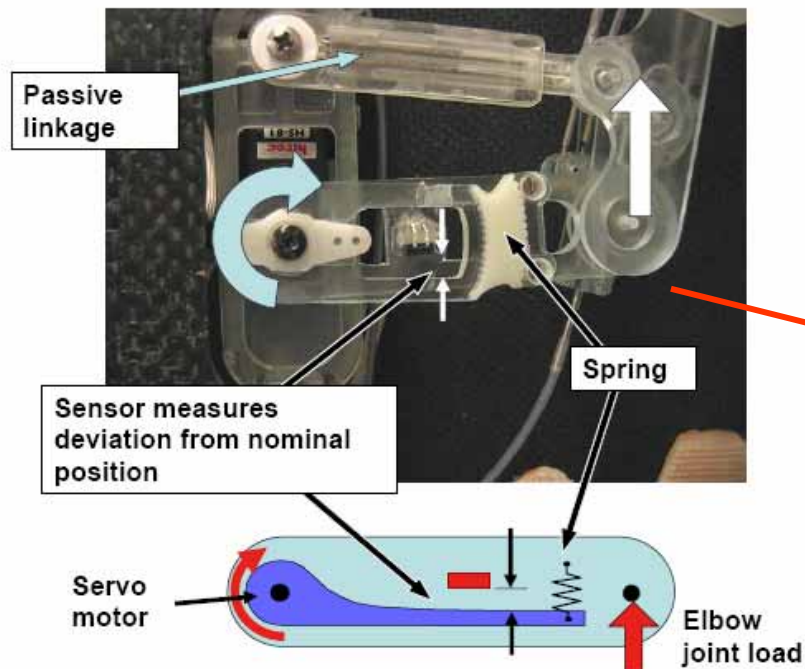

**Force sensors** located on StickyBot shoulder joints that measure the deflection of an elastomeric spring via a ratiometric Hall effect sensor

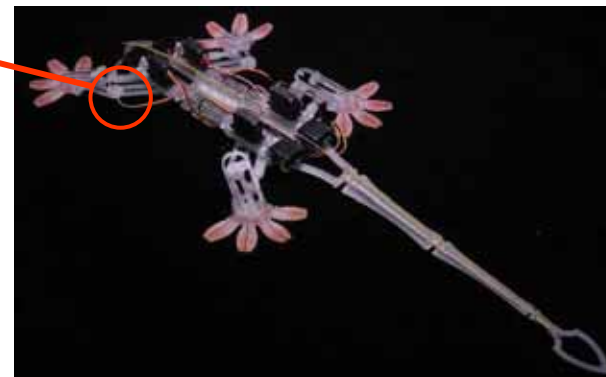

# Distributed Control of Forces

Stickybot is capable of climbing a variety of surfaces at 90 deg including glass, glossy ceramic tile, acrylic, and polished granite at speeds up to **4.0 cm/s** (0.12 bodylengths/s)

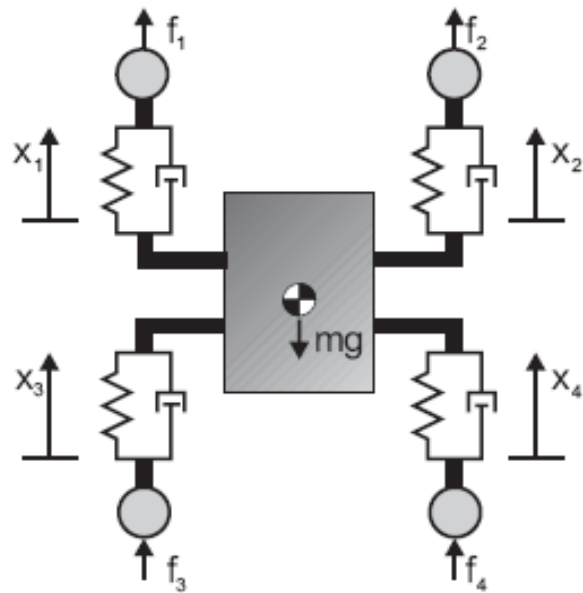

Schematic of the body model used

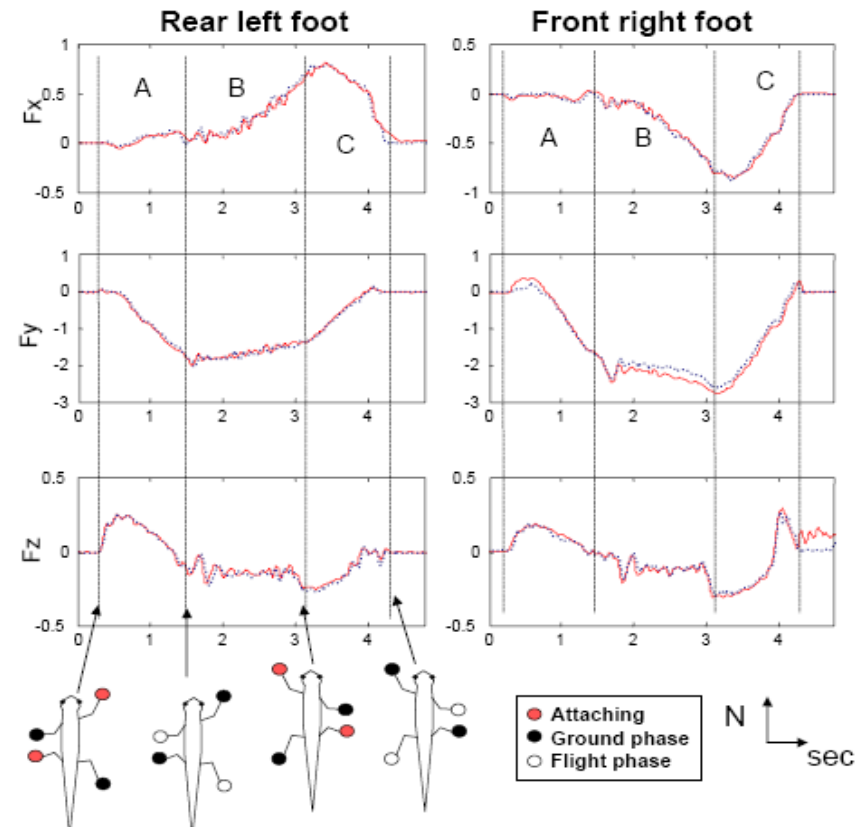

Force plate data of rear left foot (L) and front right foot (R) of Stickybot climbing with a 6s period at a speed of 1.5 cm/s.

# StickyBot at work!

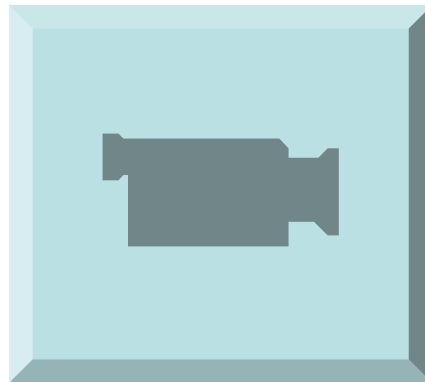

# **IV PARTE**

## **THE SHAPE DEPOSITION MANUFACTURING (SDM): TECHNOLOGY FOR BIOMIMETIC ROBOTICS**

# Biomimetic fabrication

Study biological materials, components, and their roles in locomotion.

Study Shape Deposition Manufacturing (SDM) materials and components.

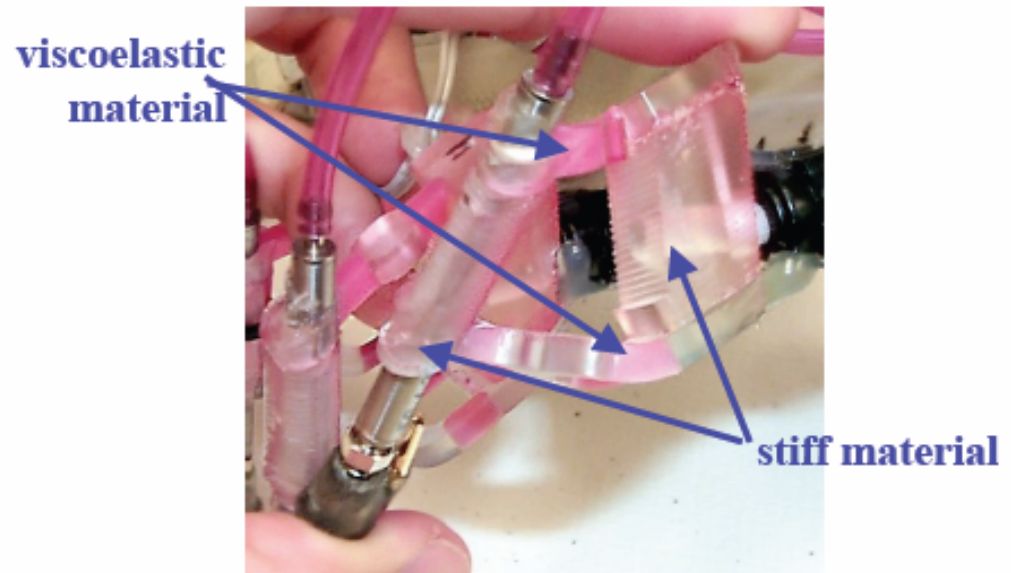
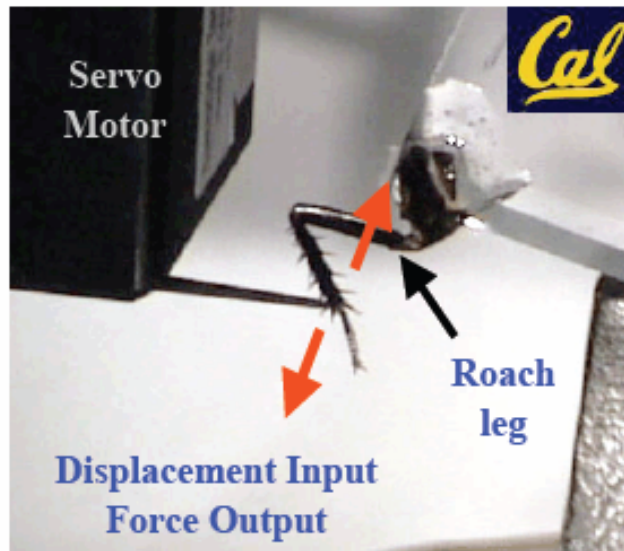

**Models of material behavior and design rules for creating SDM structures with desired properties**

# SDM - Shape Deposition Manufacturing

SDM integrates the concepts of two technologies: **Rapid Prototype (RP)** and **Computer Numerical Control (CNC)** machines.

**RP** allows to realize **moulds** in polymeric materials, following complex geometries not achievable by means of traditional machines (e.g. to realize a sphere able to move inside a square).

**CNC**, classic machines at **numerical control** (e.g. milling machine), realizes mechanical pieces in plastic and/or metallic materials, starting from CAD models.



# SDM - Shape Deposition Manufacturing

From Rapid Prototype (RP) and Computer Numerical Control (CNC) machining to . . .

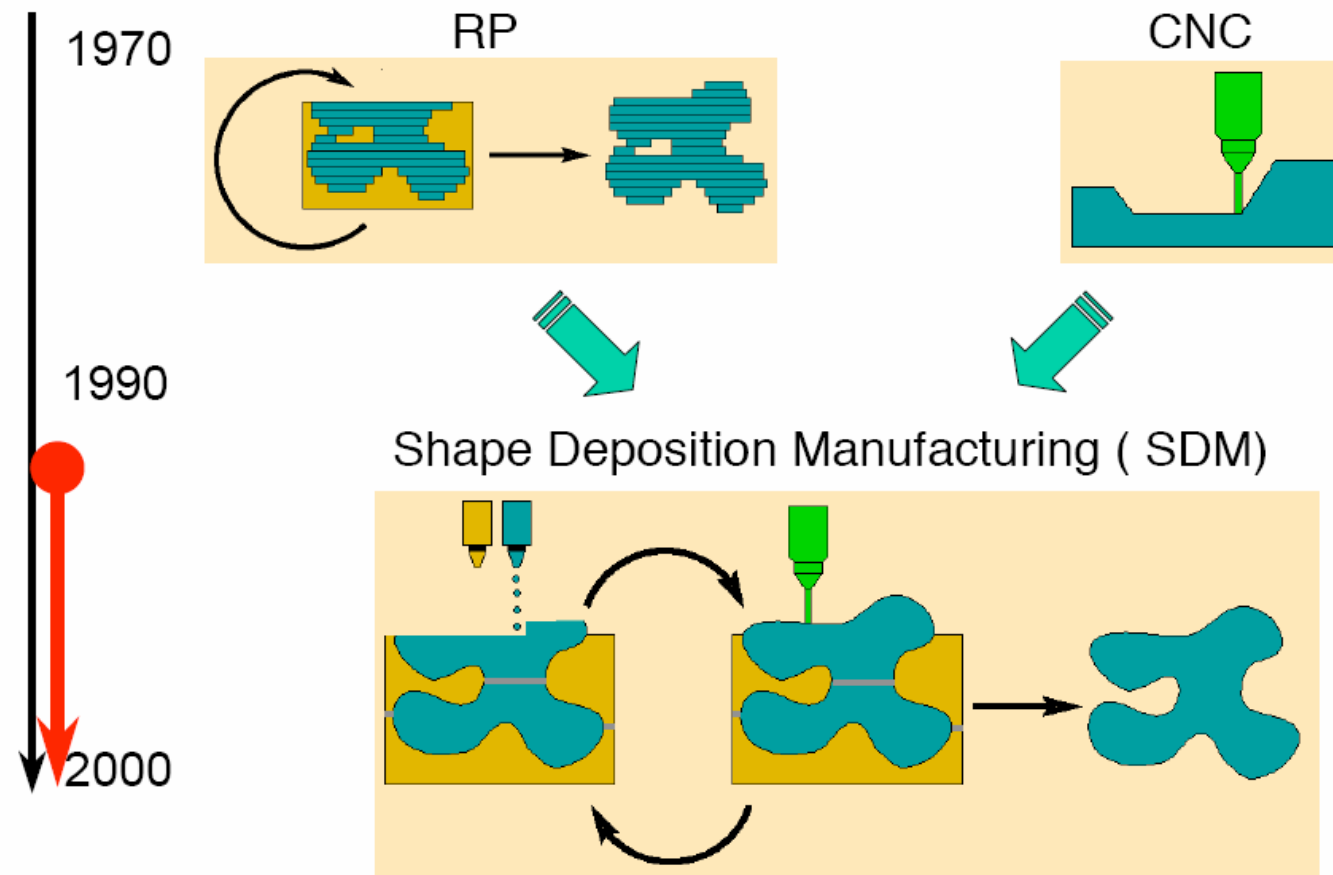

# What is SDM?

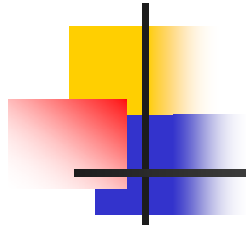

**Shape Deposition Manufacturing (SDM)** Process directly produce functional prototypes from **CAD models**.

**Shape Deposition Manufacturing (SDM)** is a layered prototyping method where **parts** or assemblies **are built up** through a cycle of alternating layers of structural and support material. After a layer of material is added, it is **then shaped** to a precise contour before the next layer is added.

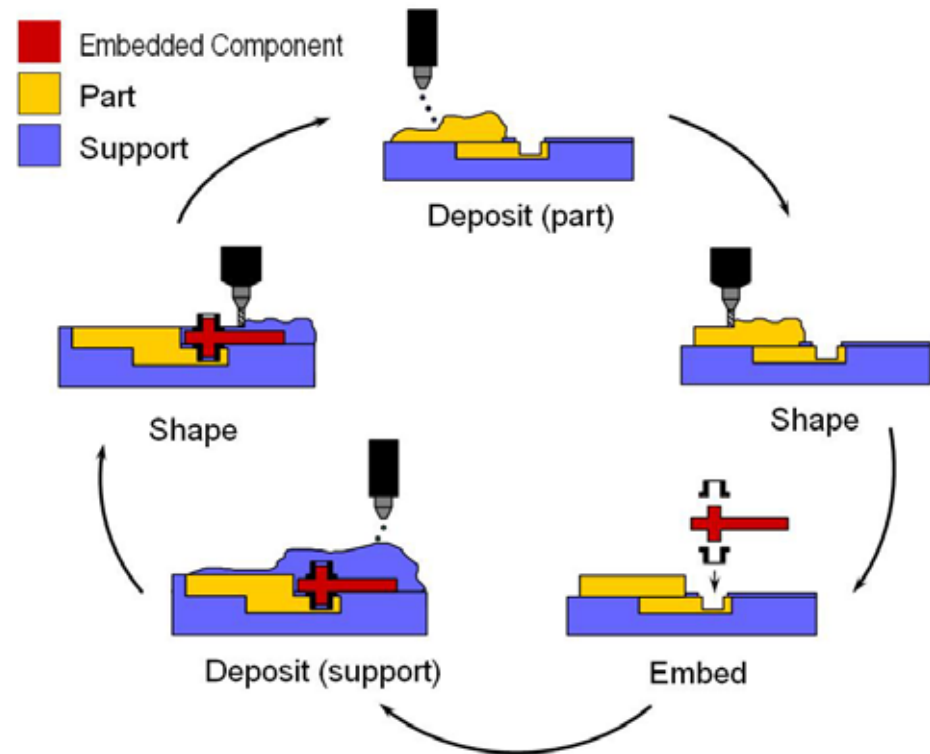

# Steps of the SDM process

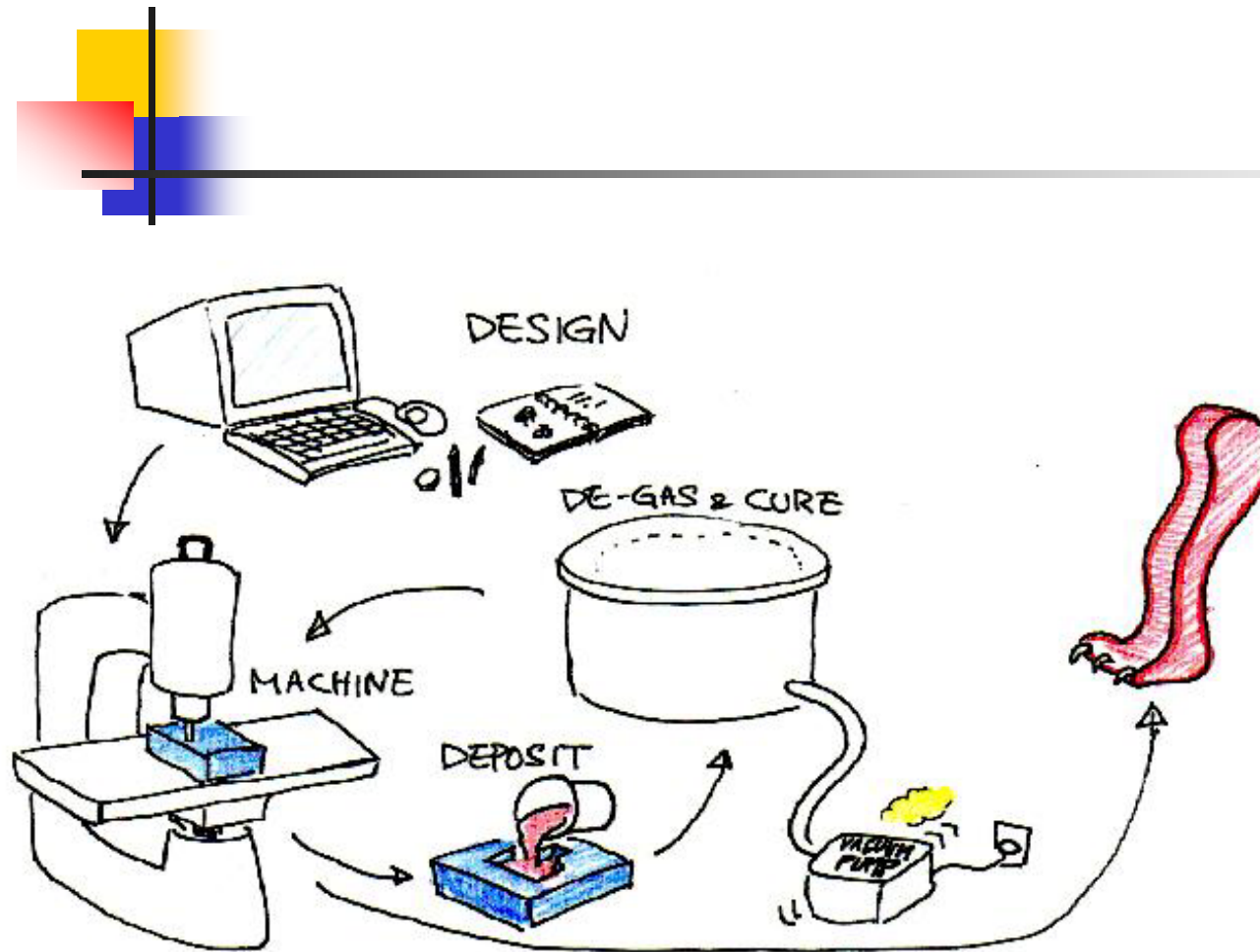

## After deposition

each layer is **shaped** using conventional CNC (Computer Numerical Control) technology, such as milling, grinding.

Additional steps objects such as prebuilt **mechanical parts, electronic components or circuits and sensors** can be **embedded** into each layer.

**Multi-material** layers can be manufactured by repeating the cycle for each of the materials.

# Biomimetic fabrication

The construction of the multi-material compliant leg used in the robot takes advantage of SDM's capability **to vary the material properties** during construction of the part.

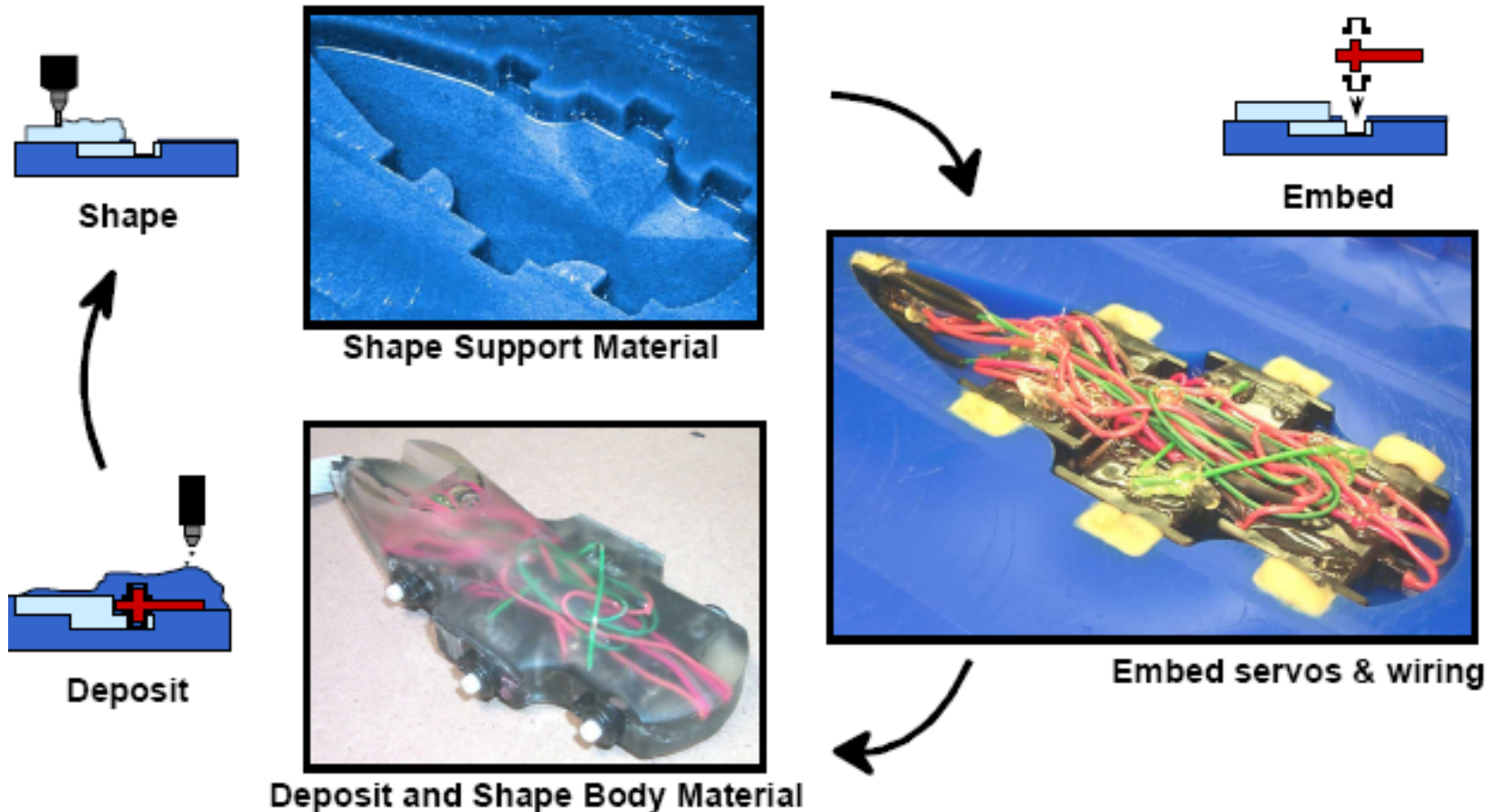

# How to make an egg

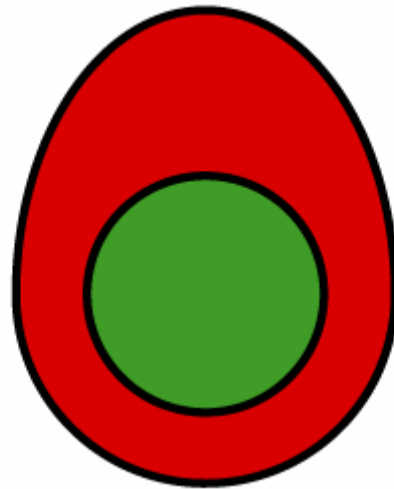
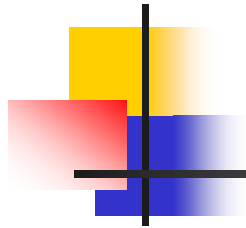

# Main applications of SDM at BDML



Current applications of the SDM process include the manufacture of **custom** tools (e.g. injection molds with internal cavities (cooling channels), **multimaterial** inserts (e.g. Cu pipes for heat distribution) and **embedded sensors**, functional prototype parts and shape-conformable **embedded electronic structures**.

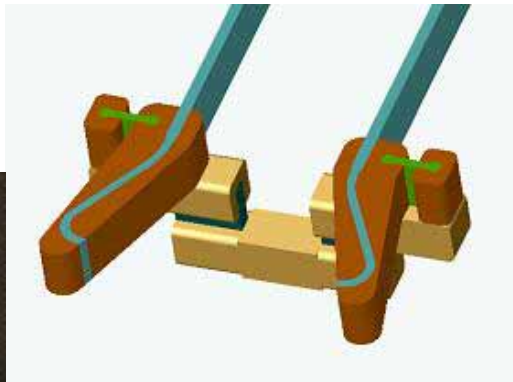
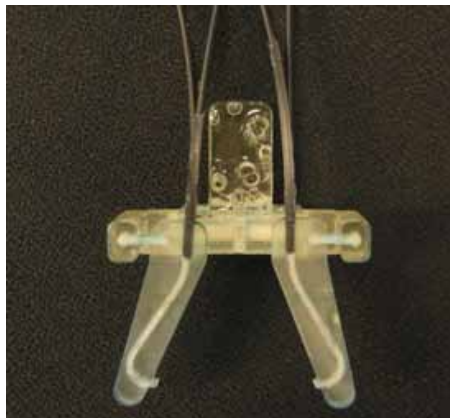

# Cool SDM stuff to date

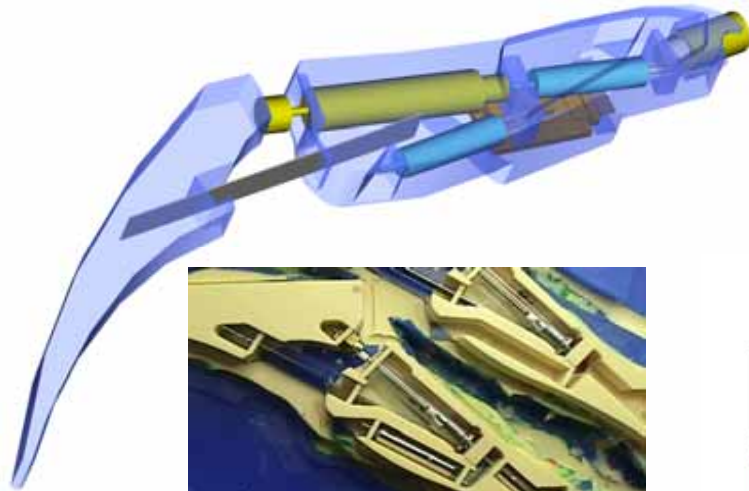

**Embedded components**  
Cham et al., 1999

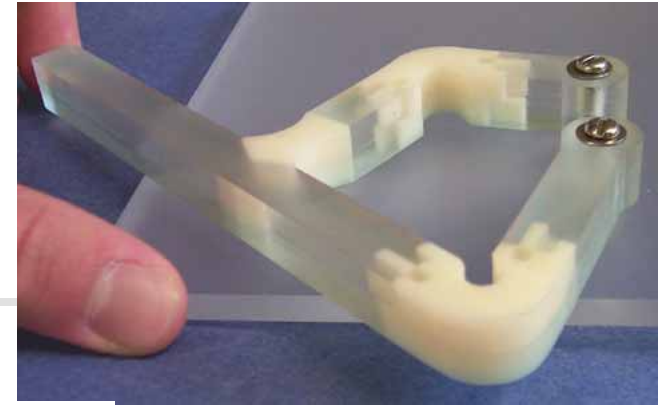
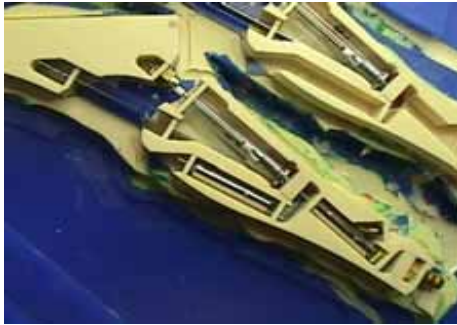

**Multi-materials** - Roger, 2000

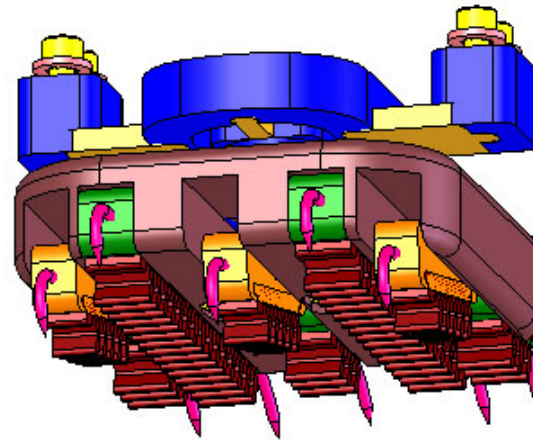

**RiSE foot V4** (2-17-04)



**Fiber-reinforced joints**  
Moto, 2001

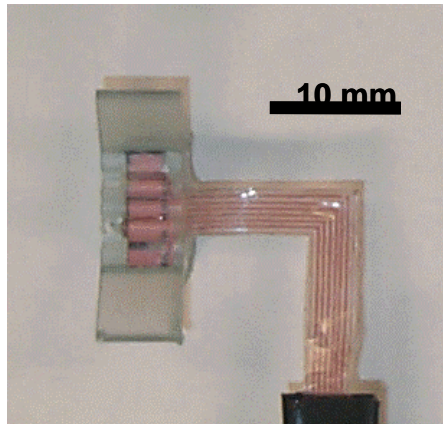

**Embedded sensors**  
Wuensch., 2001

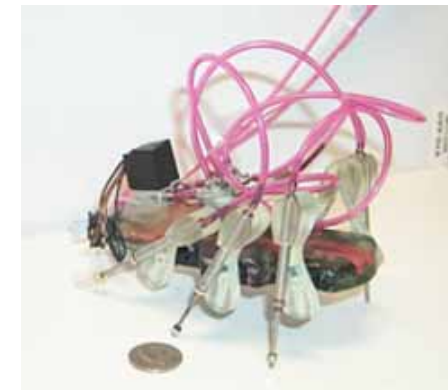
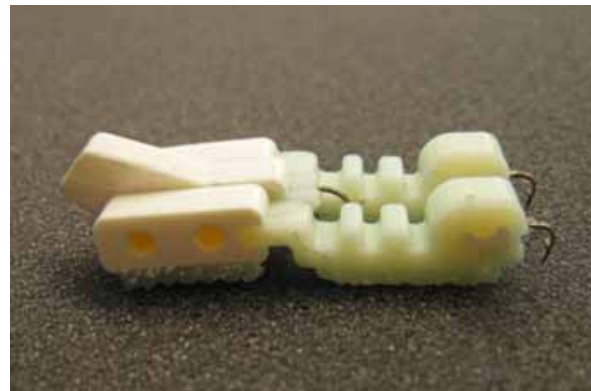

# Graded Materials

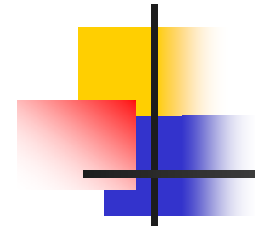

- Pin Joints Replaced With Flexural Regions to Introduce locally tailored Compliance and Damping
- More robust than a pin joint...
- More robust than using a single homogeneous material and varying flexure thickness

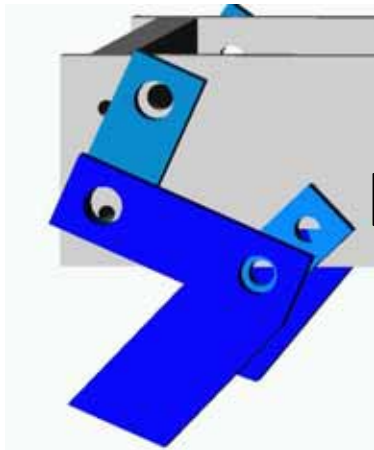

Original Design

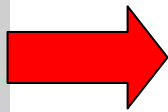

SDM Re-Design

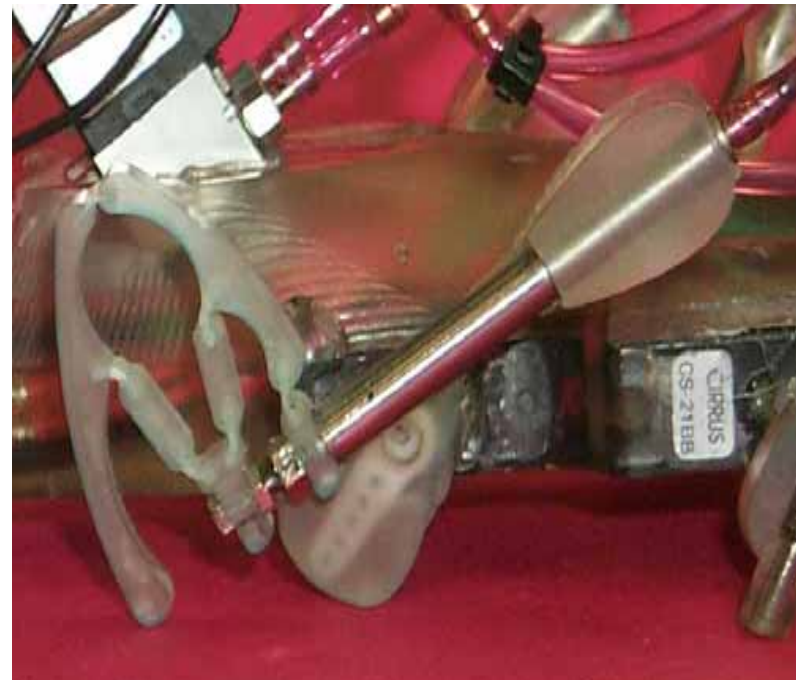



# SpinyBot foot

Soft  
Polyurethane

Hard  
Polyurethane

Planar toes

Enlargement of  
spines

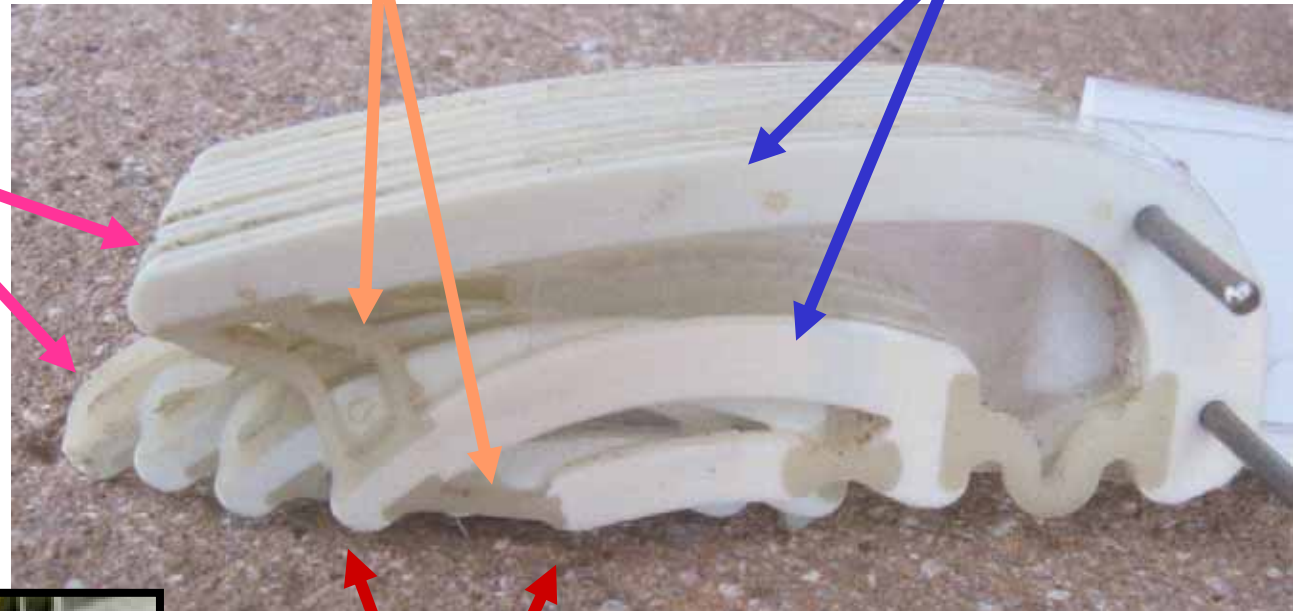

Spines

# Spinybot II

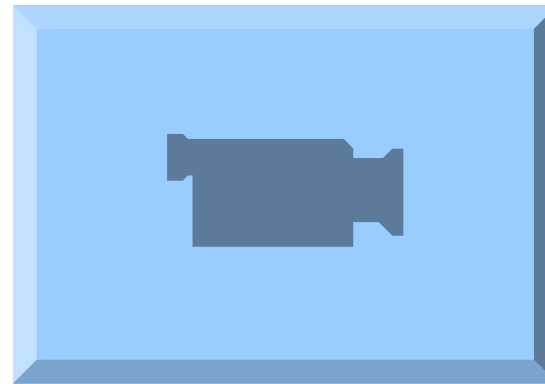

# SpinyBot body

- Totally rote—just fixed servo movement pattern
- COM well within polygon of wall contacts—very stable
- 400g bodyweight

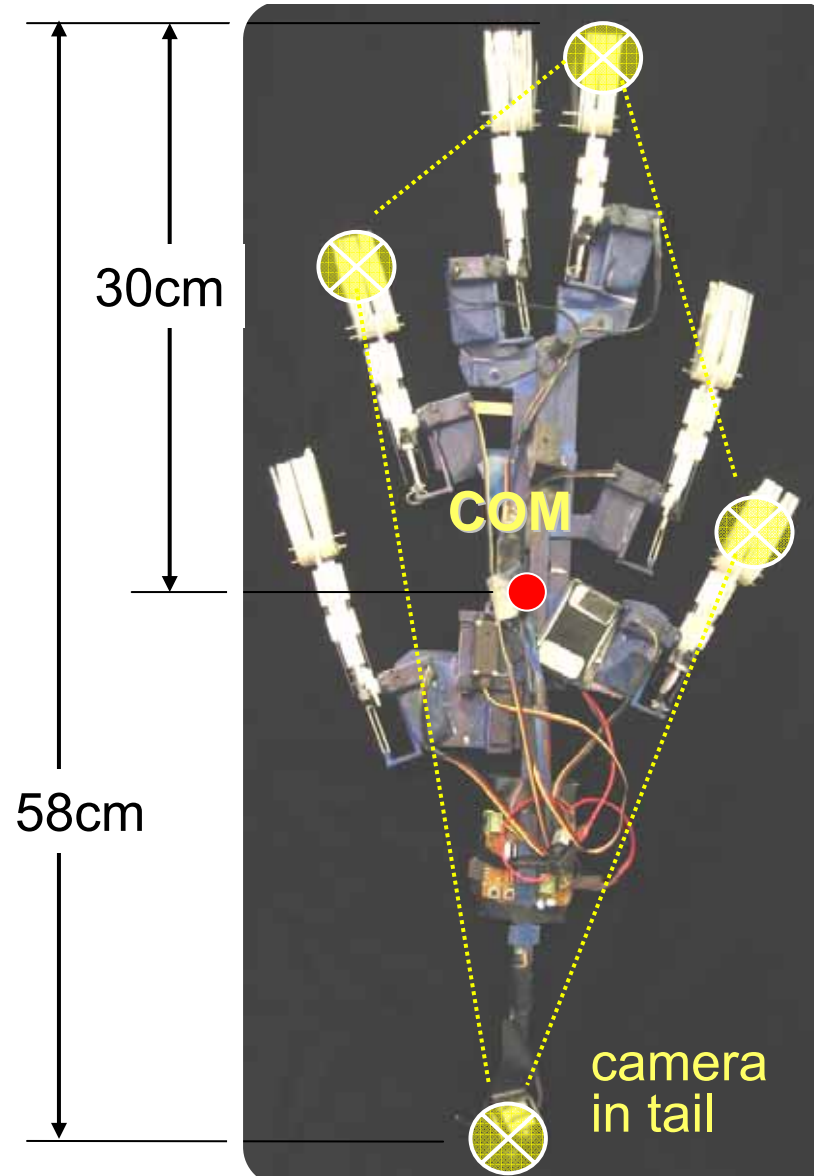

# SpinyBot Stats

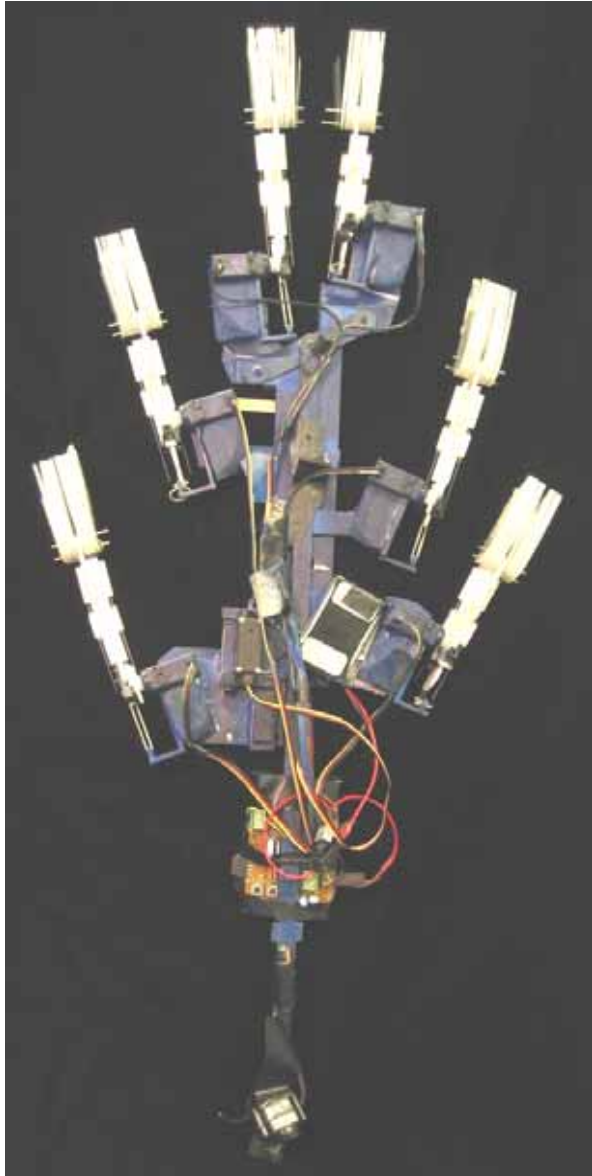

- Mass: 400g
- Max. payload: 400g
- Speed: 2.3 cm/sec
- Controlled DOF: 3
- 20 spines/foot

# Foot Manufacturing: Shape Deposition Manufacturing



# From the original design of the rat-robot....

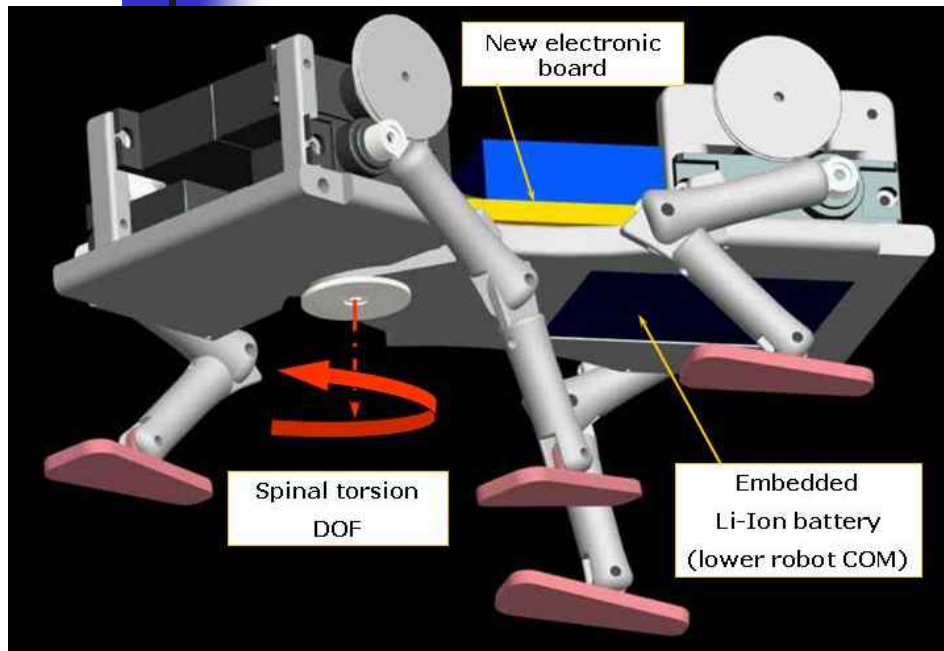

Rapid prototyping:  
3D printer; discrete DOF

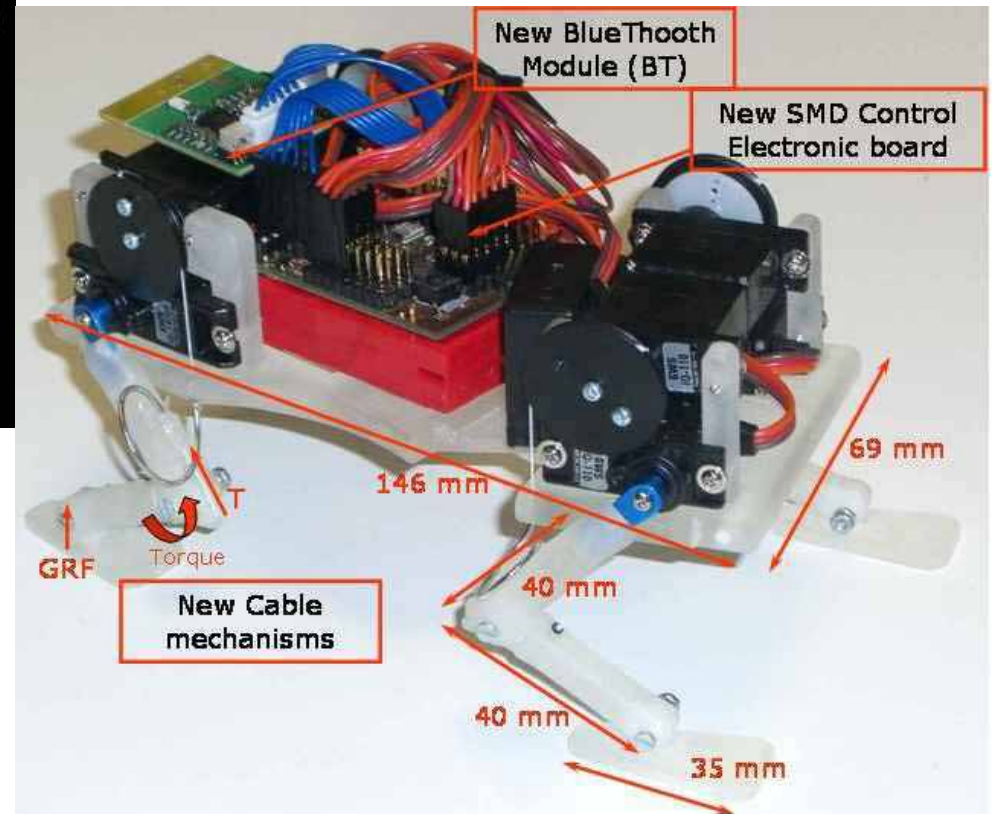

Traditional link joints:

Pin joints, internal springs, screws,  
bolts...

# ...to the SDM re-design of the Rat-Robot joints



Knee Joint

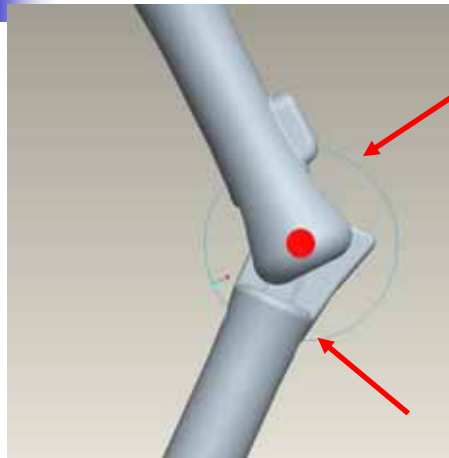

Traditional discrete rotational joint

Rat leg: 2 connected links

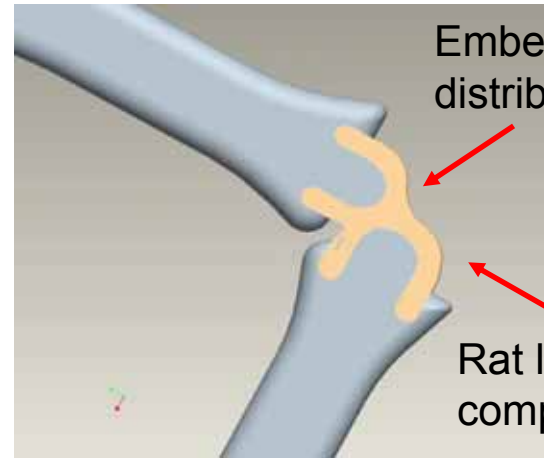
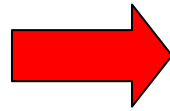

Embedded knee distributed joint

Rat leg: single component

Original Design

SDM Re-Design

Ankle Joint

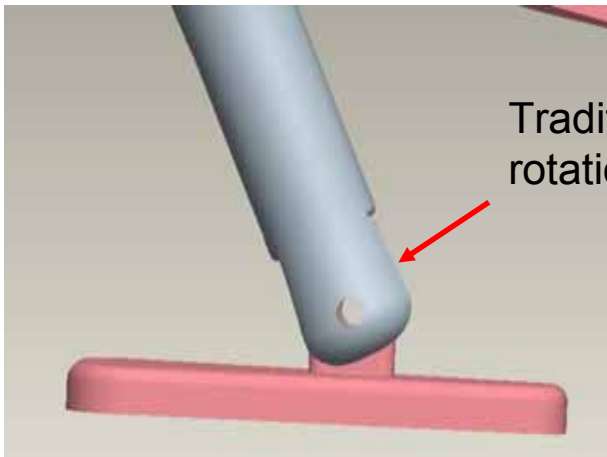

Traditional rotational joint

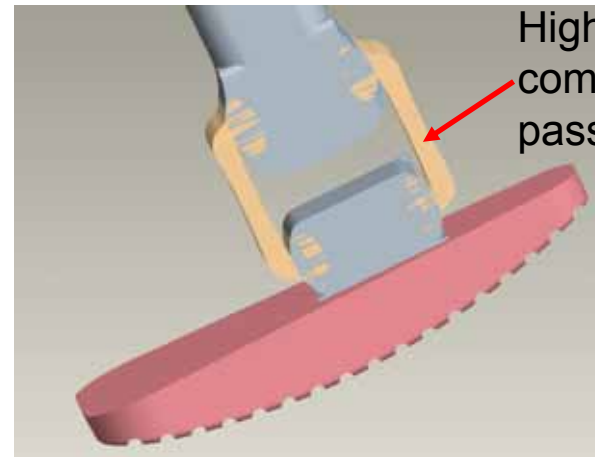
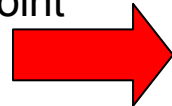

High compliant passive joint

# ...to the SDM re-design of the Rat-Robot joints

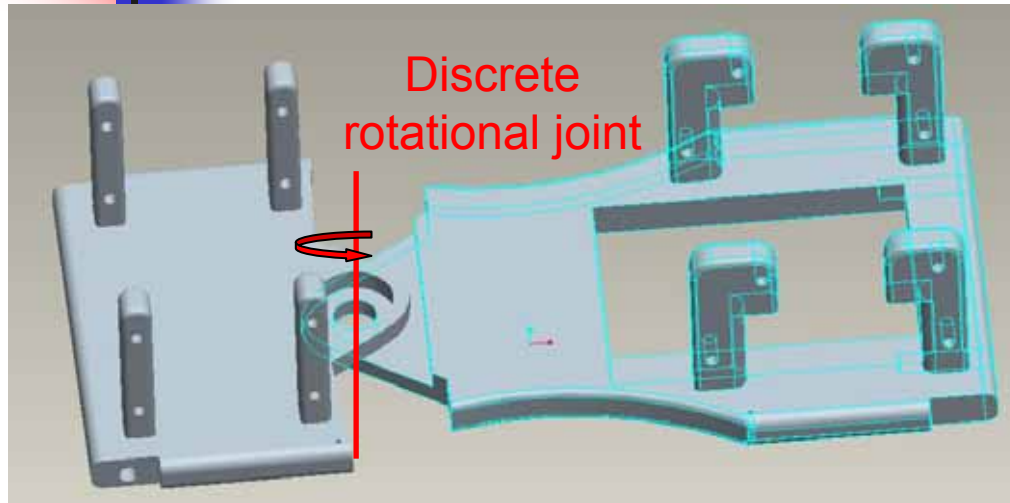

Original Design

Flexible spines: the flexion is distributed all along the spine

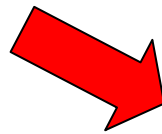

SDM Re-Design

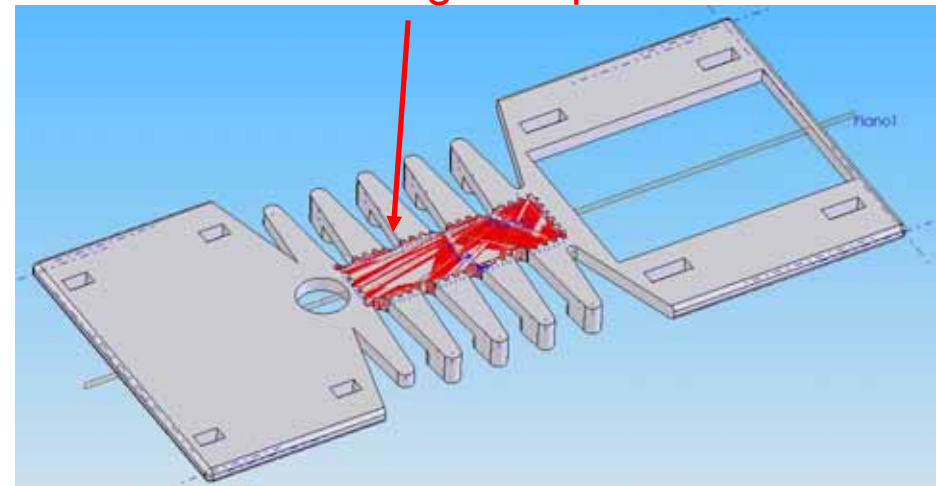



# Parametric design of the Knee Joint

2 possible variables on the design of the SDM compliant joints

- Intrinsic material characteristic: Young modulus, demold time, shore hardness, tensile strength, elongation at break...
- Joint geometry: thickness, shape, contact surface...

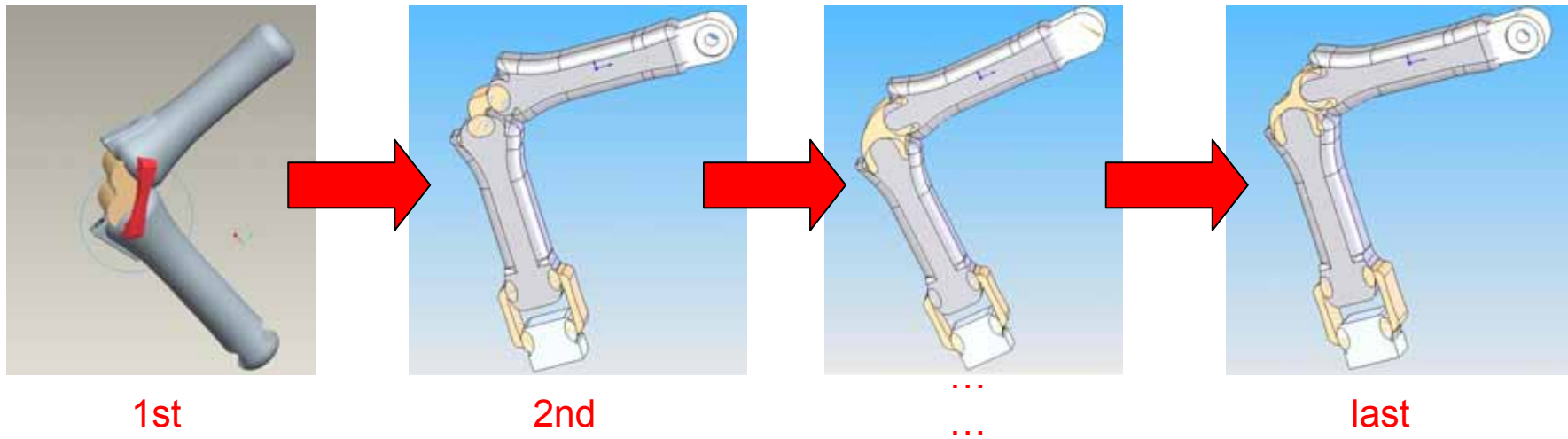

Drawback: from the 1st prototype to the last one.....empiric process: trails and errors. There is not an automatic method and rules that allow to build the desired mechanical parts starting from the design.

# Parametric design of the Knee Joint (continue)

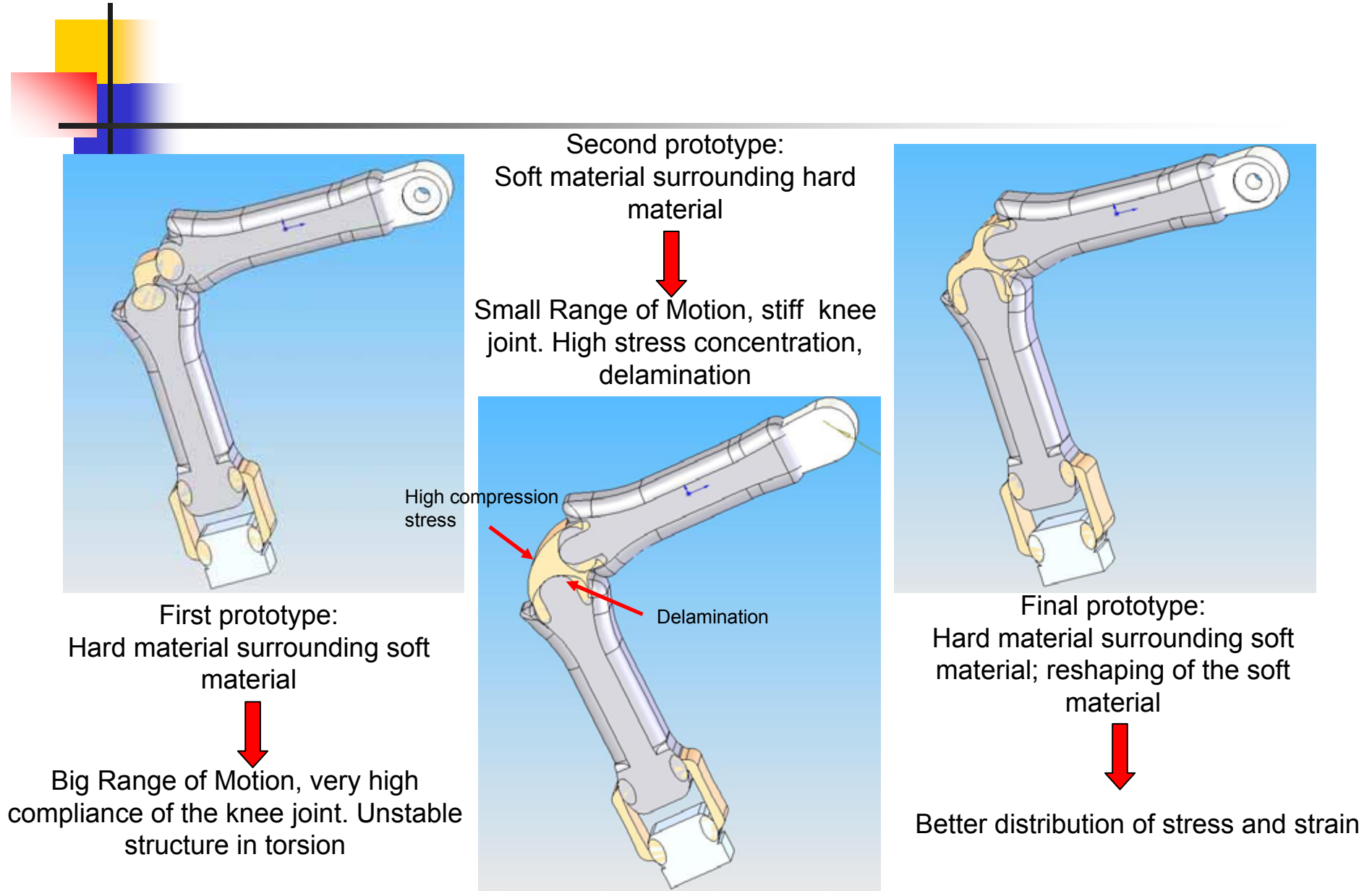

# Manufacturing of the Prototypes CAD models

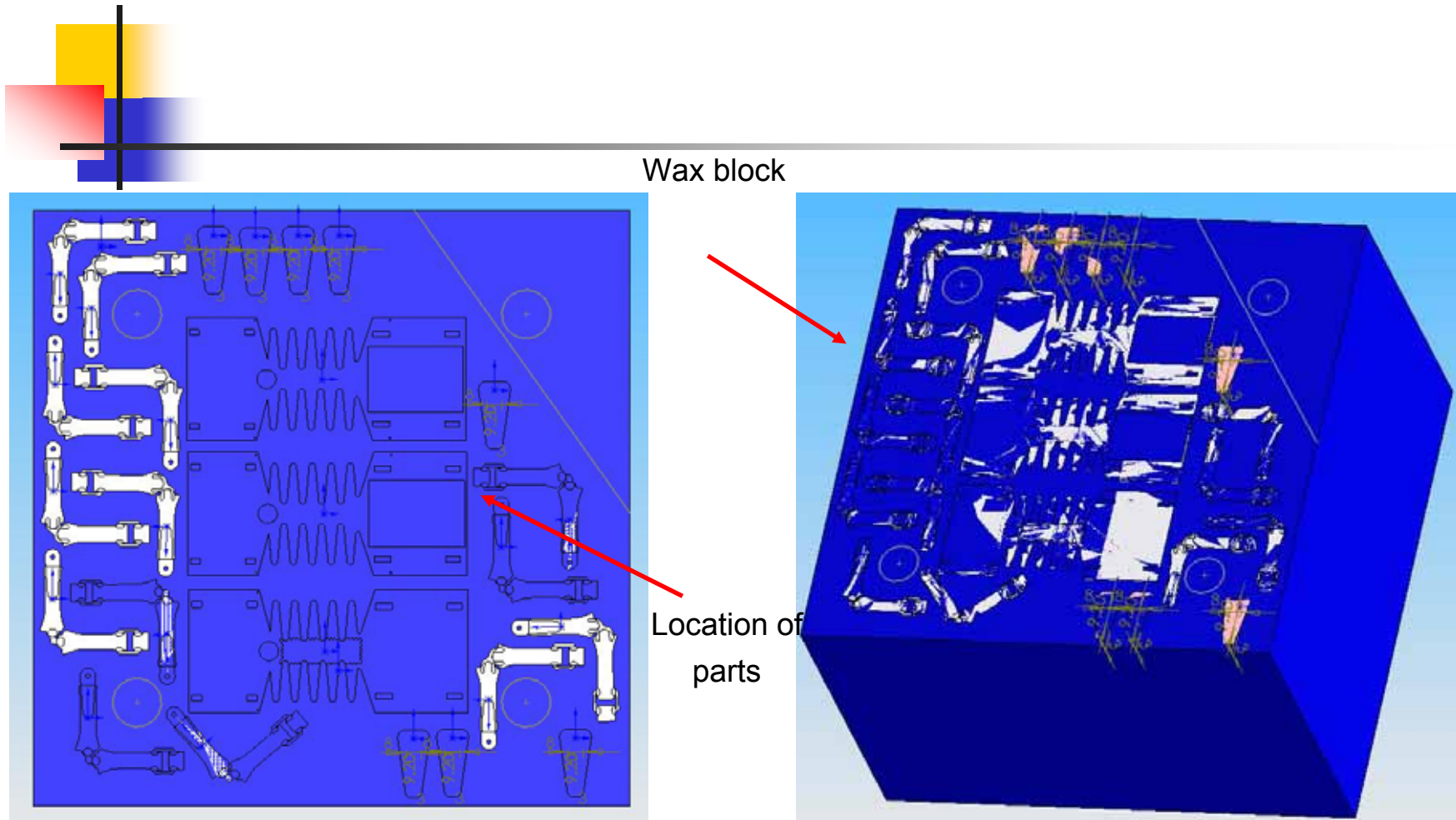

CAD model: all the parts and assemblies are placed on the wax block for creating the cavities

# Developing the moulds with the CNC tool machine



The tool paths are created layer by layer according to the different material to be machined

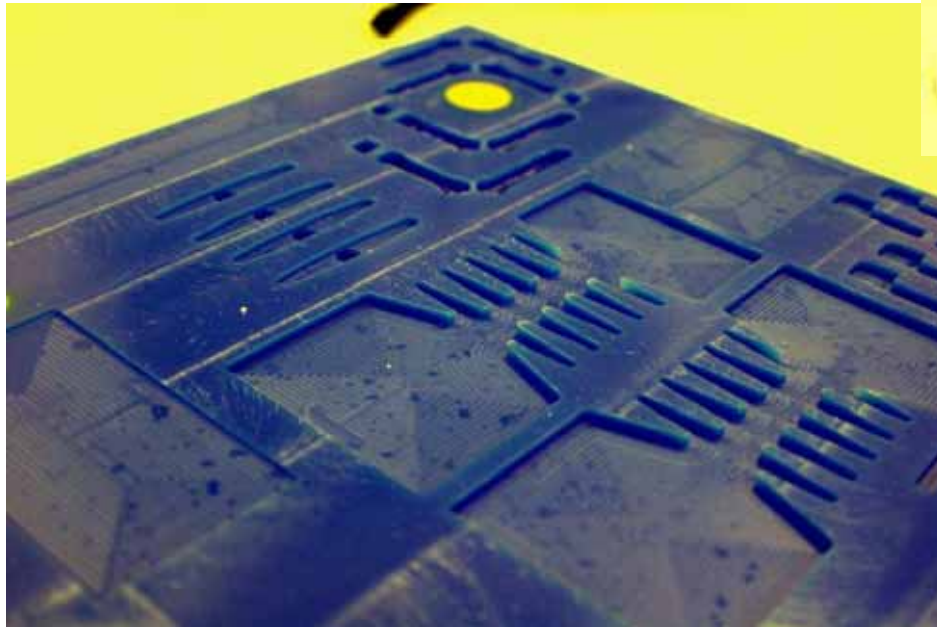
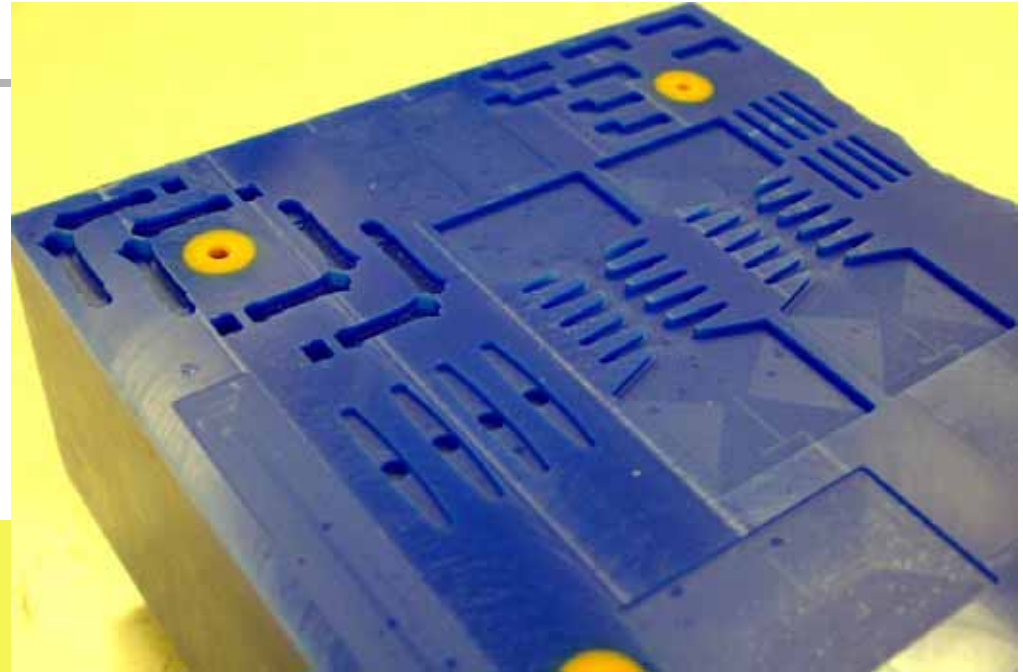

The hard material cavities are created.

Second step: pouring the polyurethane

# Developing the moulds with the CNC tool machine (2)

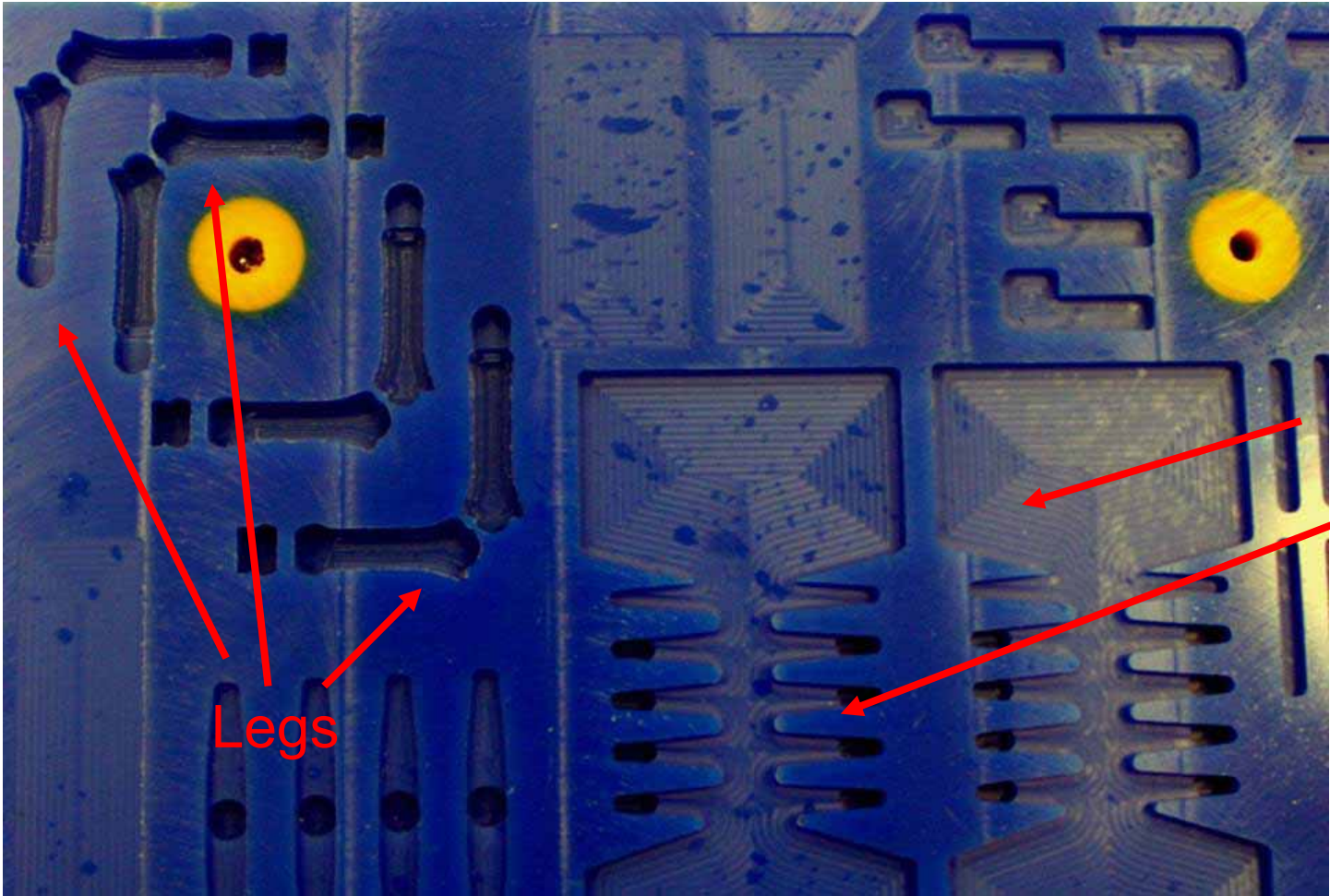

Legs

Body parts

# Developing the moulds with the CNC tool machine (2)

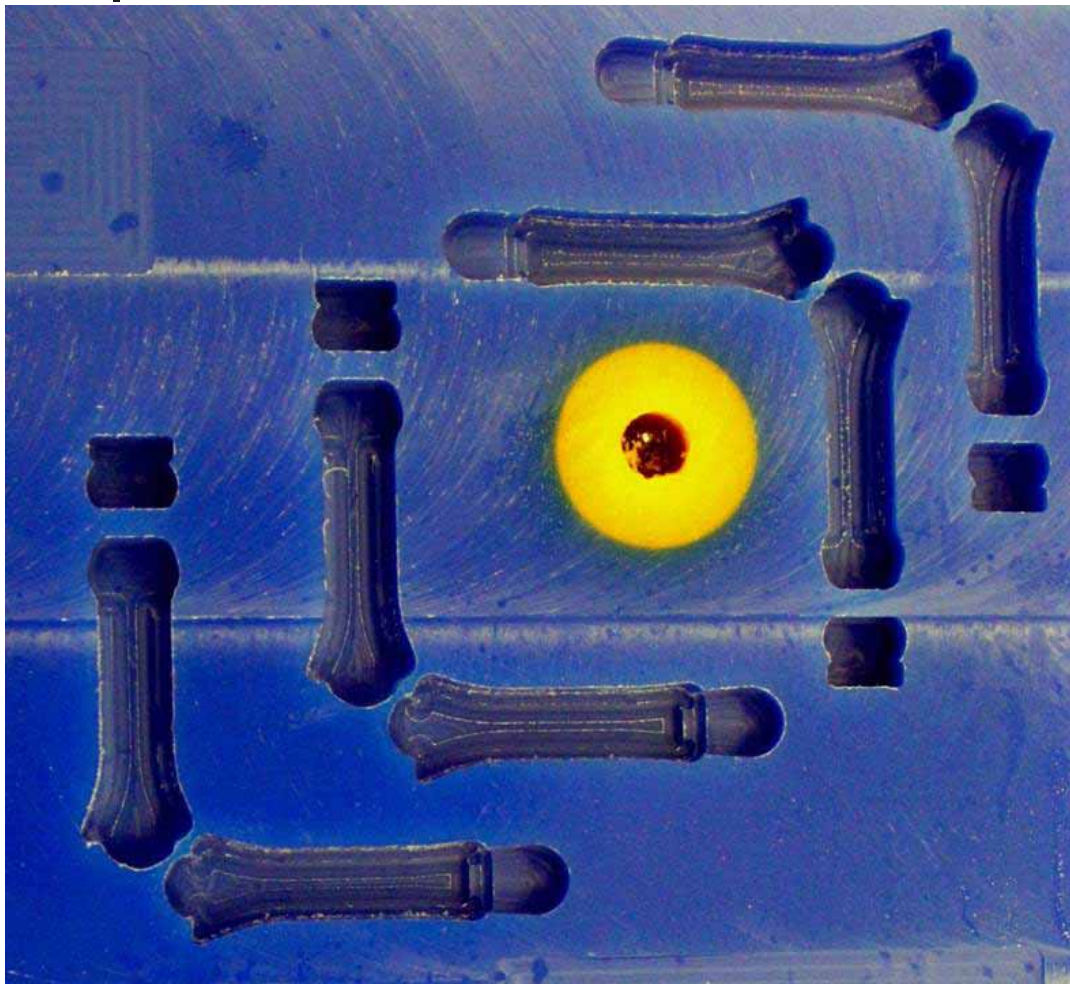

**Hard material (72 DC)  
developing caves:**

**Mix Ratio Resin to Hardner by wt.:  
100/50**

**Gel Time (min) 17-20**

**Demold Time 10 Hrs**

**Hardness 65-75 D**

**Tensile Strength ASTM D-638 4000  
psi**

**Elongation at Break 60%**

# Placing the embedded parts

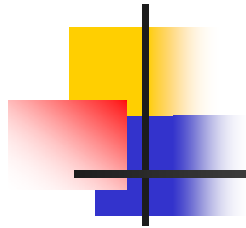

Connecting rod  
to servos are  
placed before  
casting the hard  
material

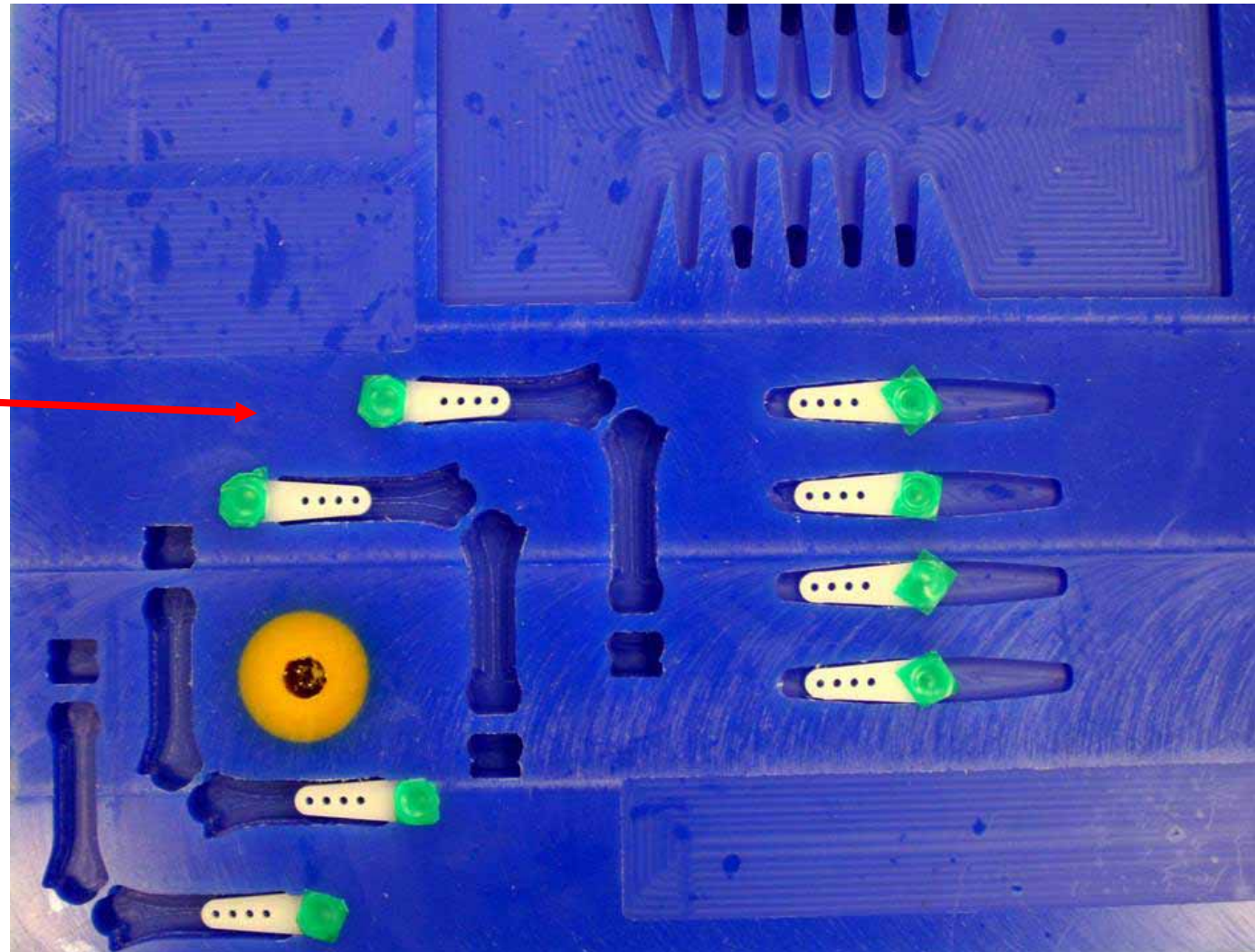

# Realization of the first prototypes

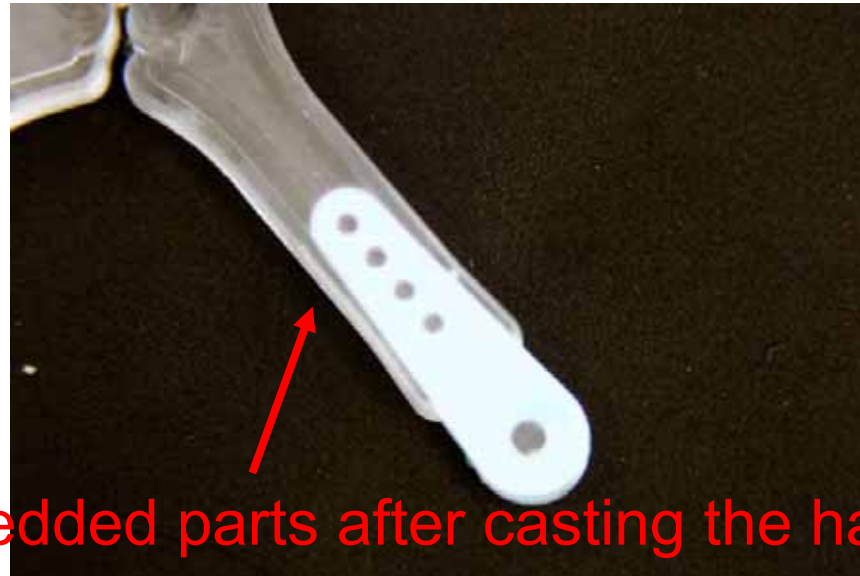

Embedded parts after casting the hard material

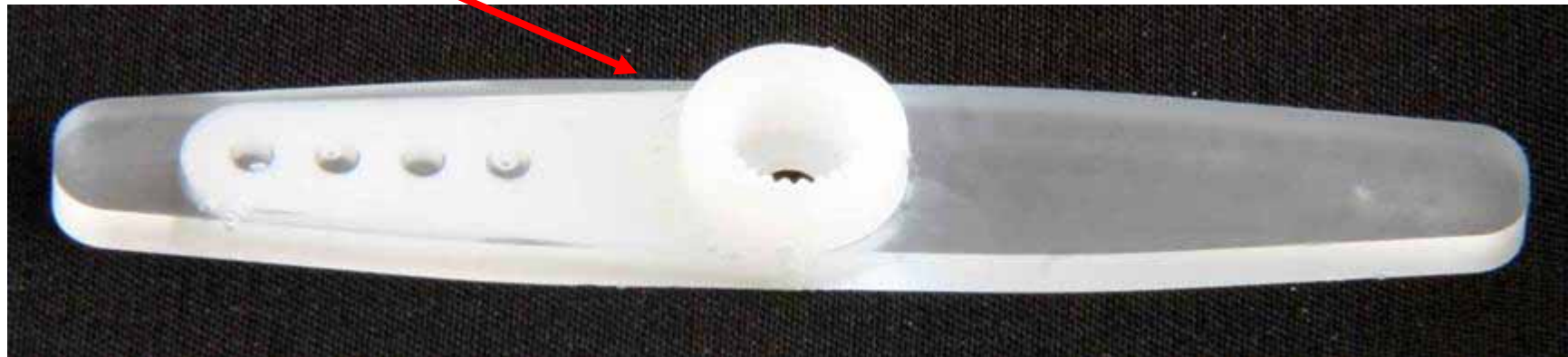



# Realization of the first prototypes (2)

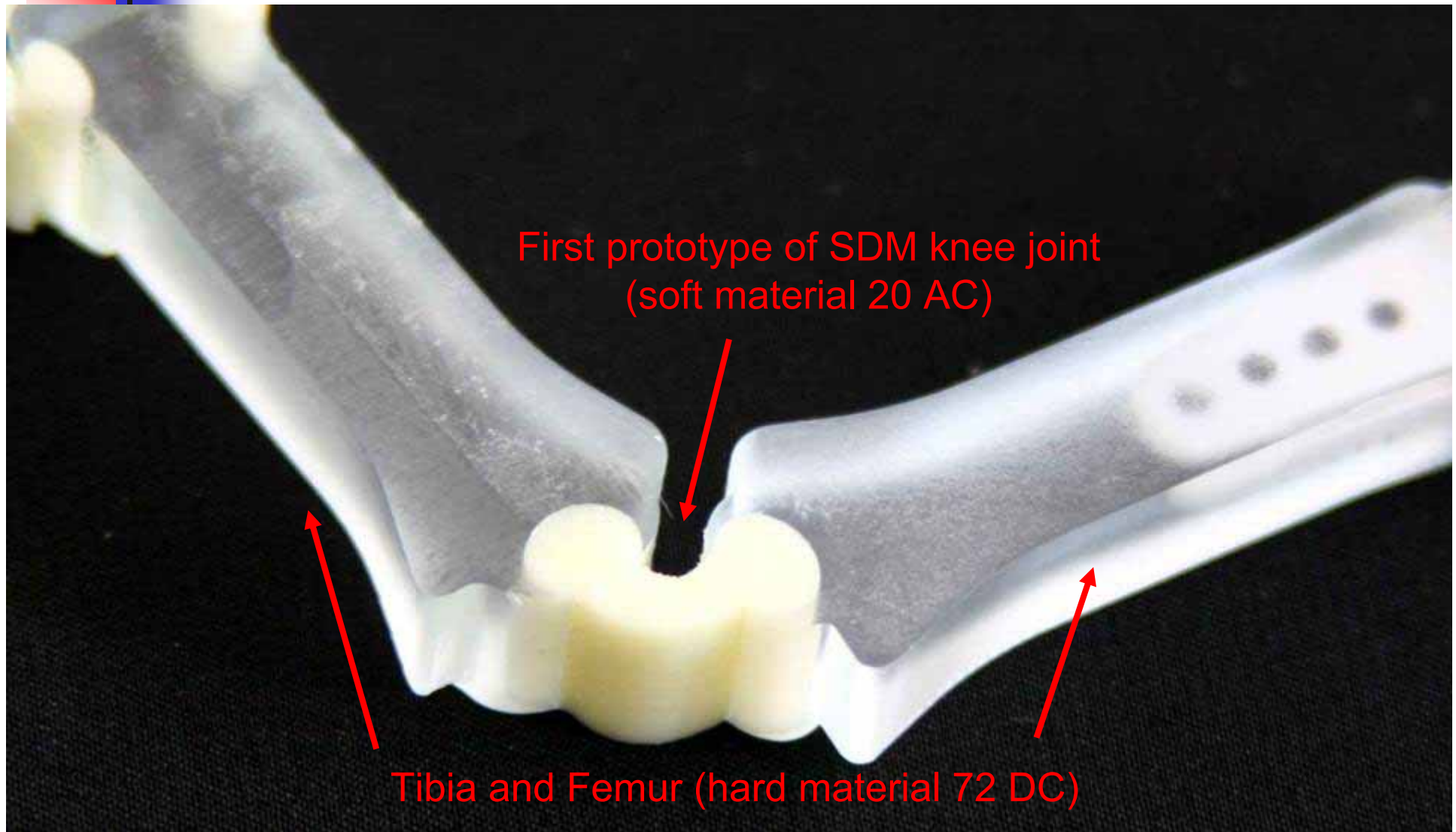

# Silk reinforced prototype of SDM knee joint (soft material 20 AC + silk fiber)

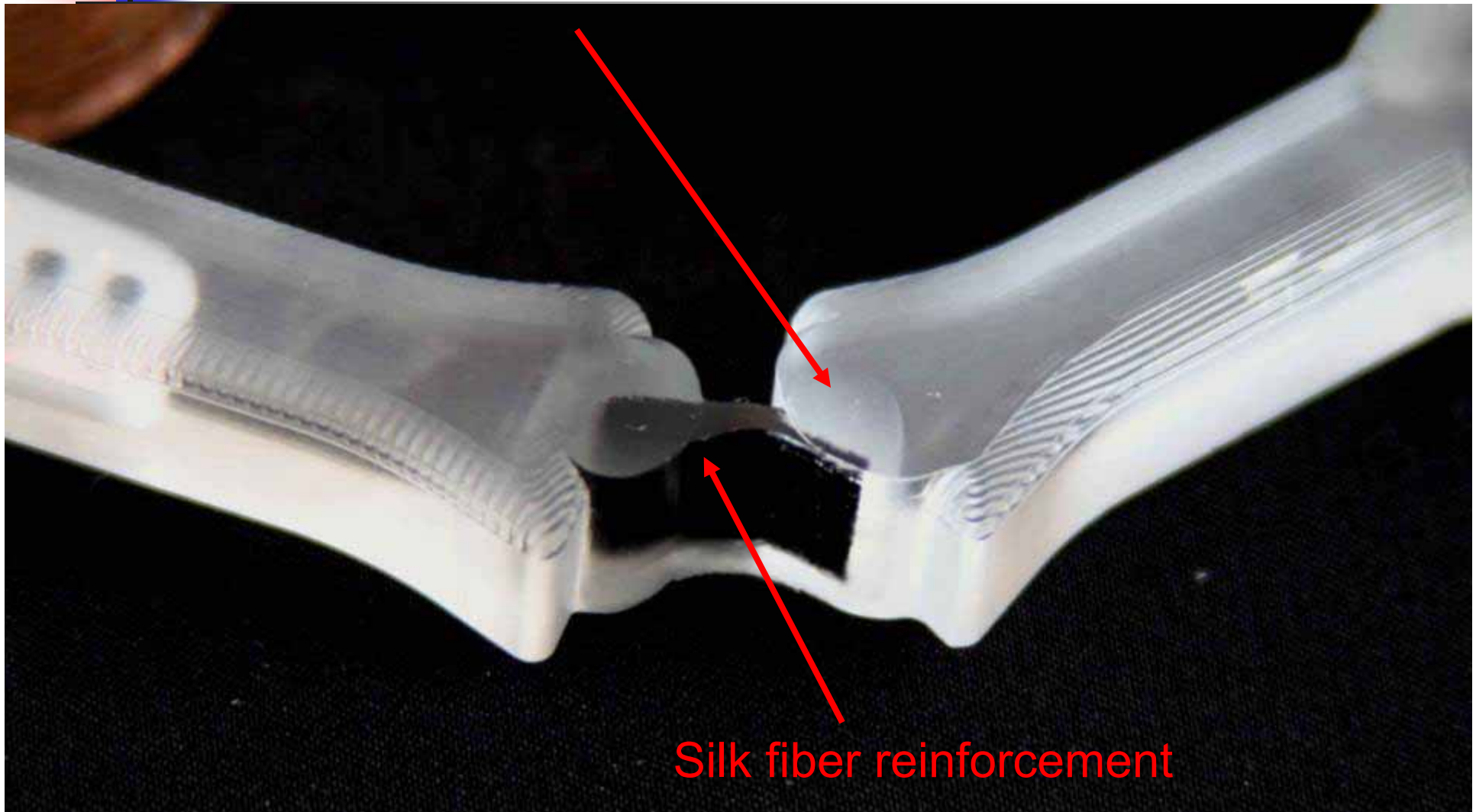

# Developing of compliant foot (soft material 20 AC)

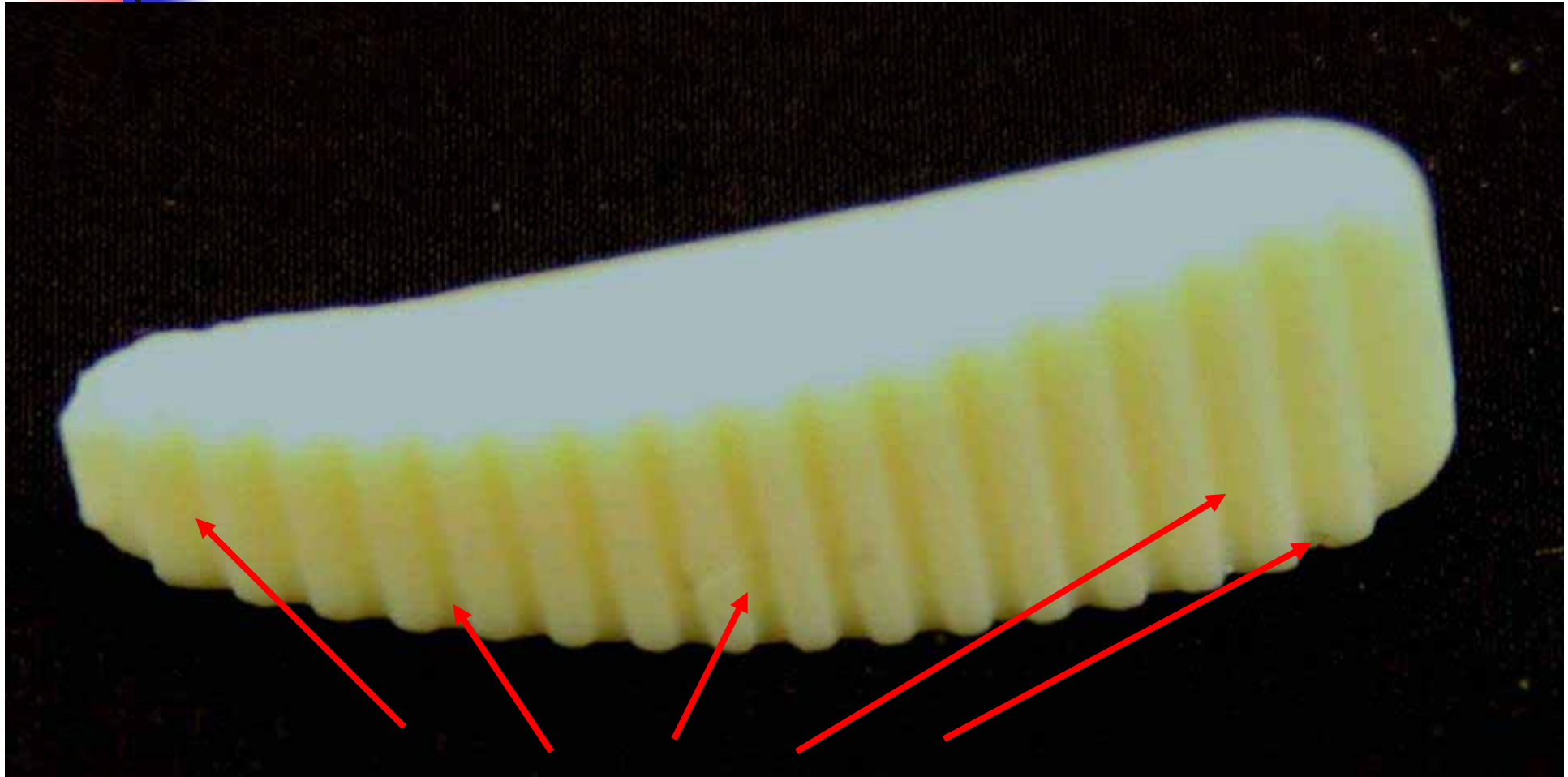

Grooves for a better grip during gait

# First prototype of high compliant ankle joint (soft material 50 AC)

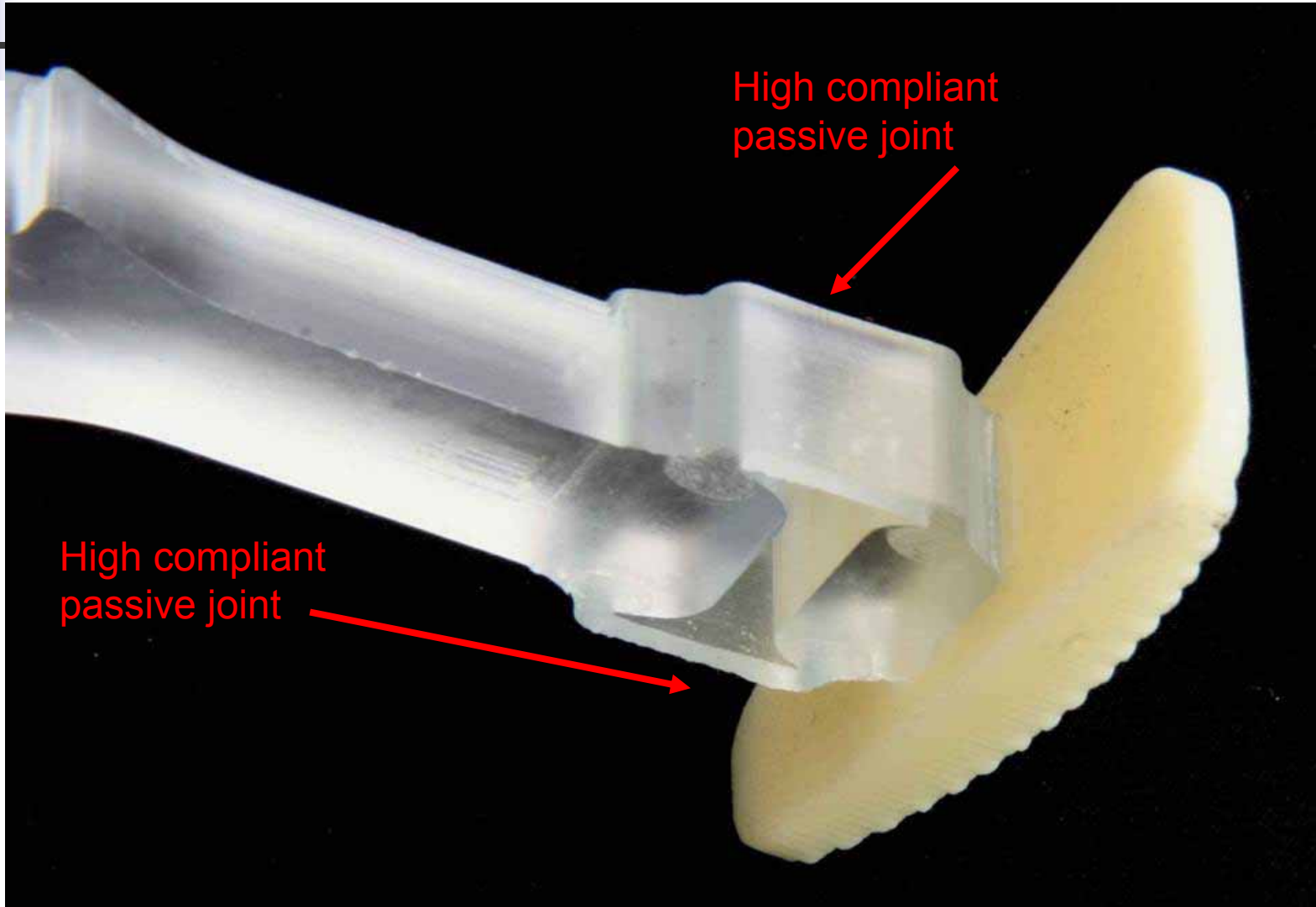

Adaptive passive  
behavior of the Ankle  
compliant joint  
during gait

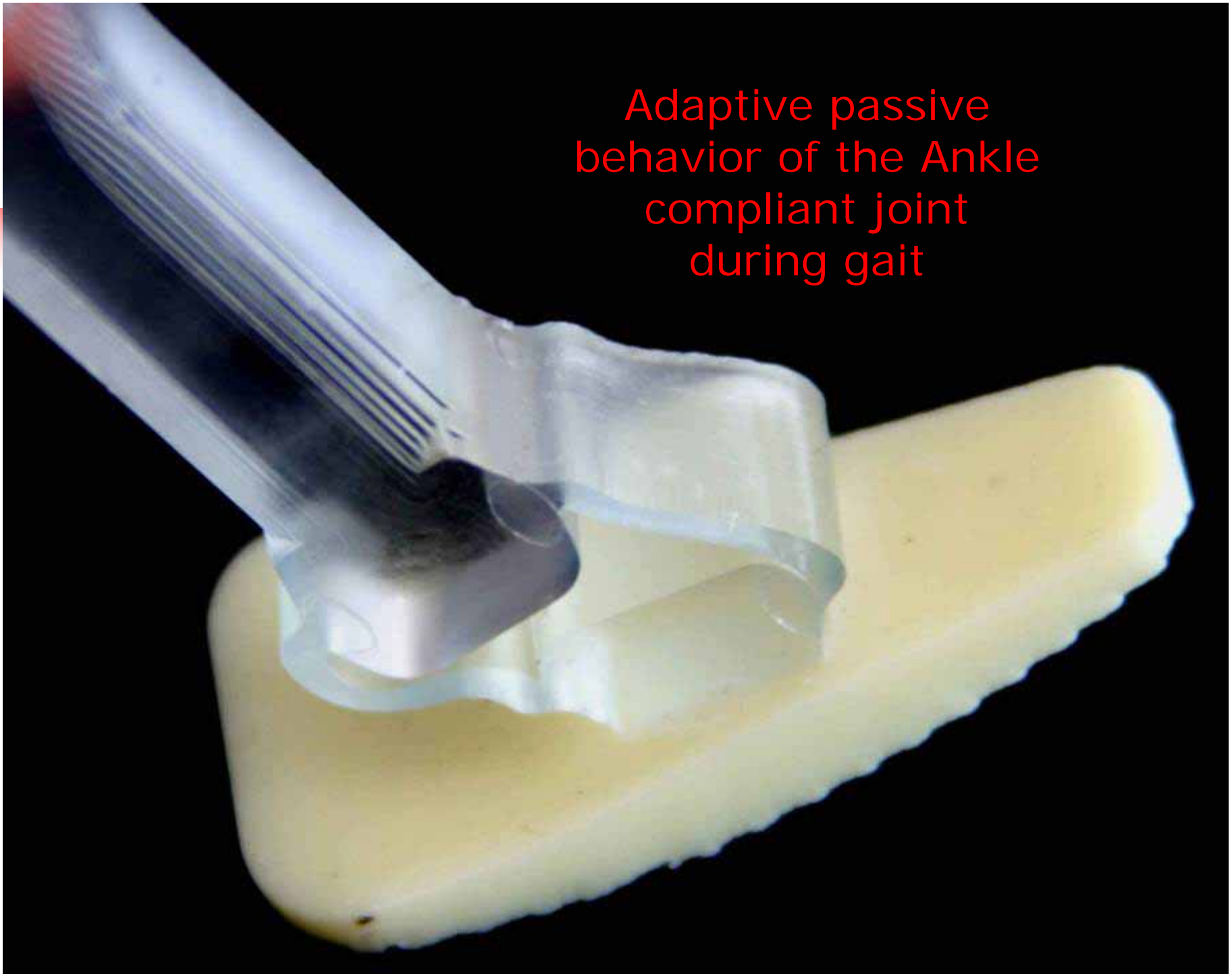

# On the design of the flexible spine

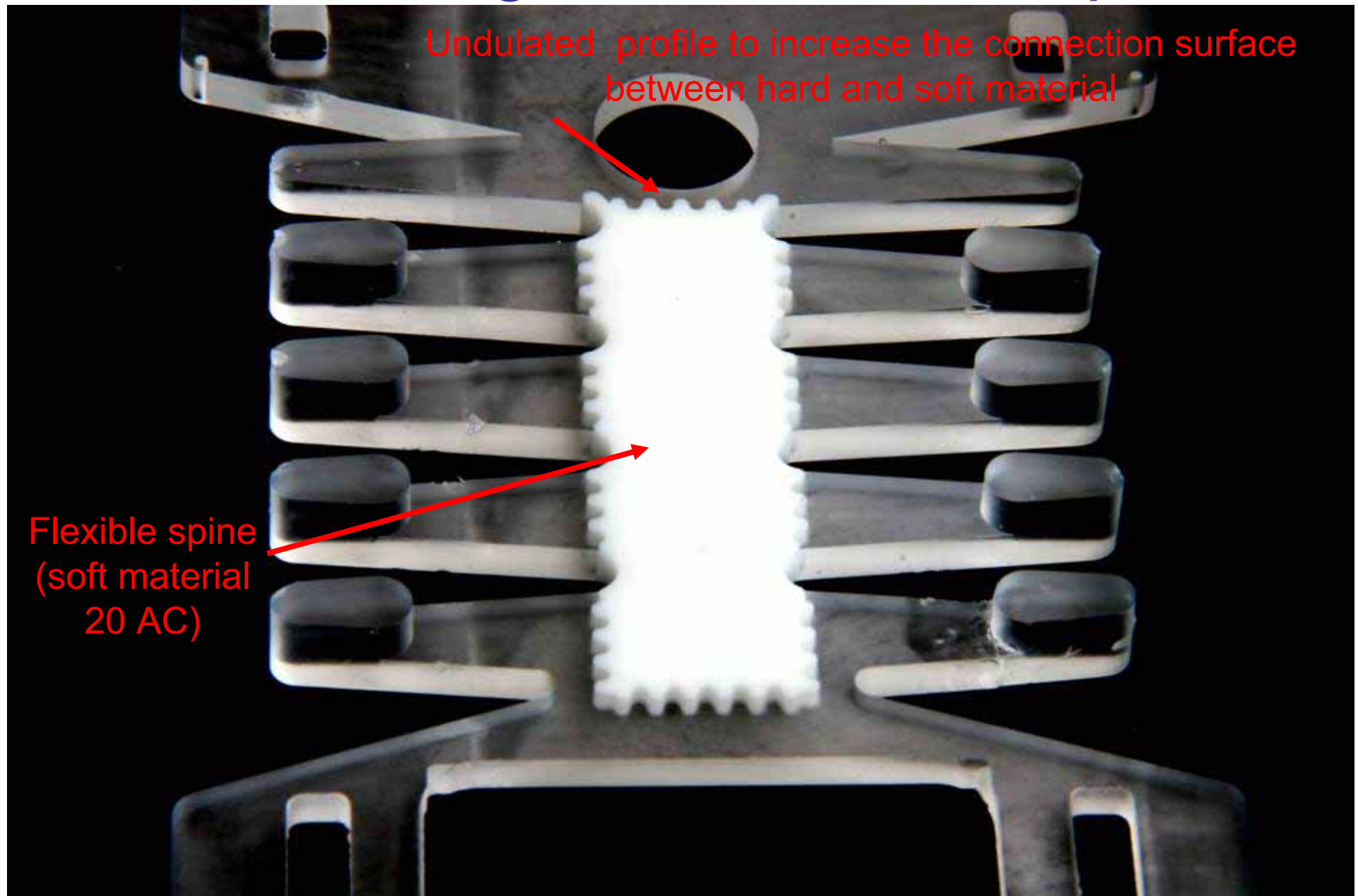

# On the design of the flexible spine (2)

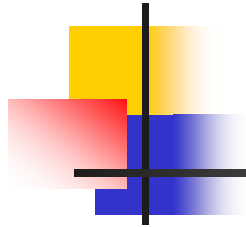

Distributed flexion

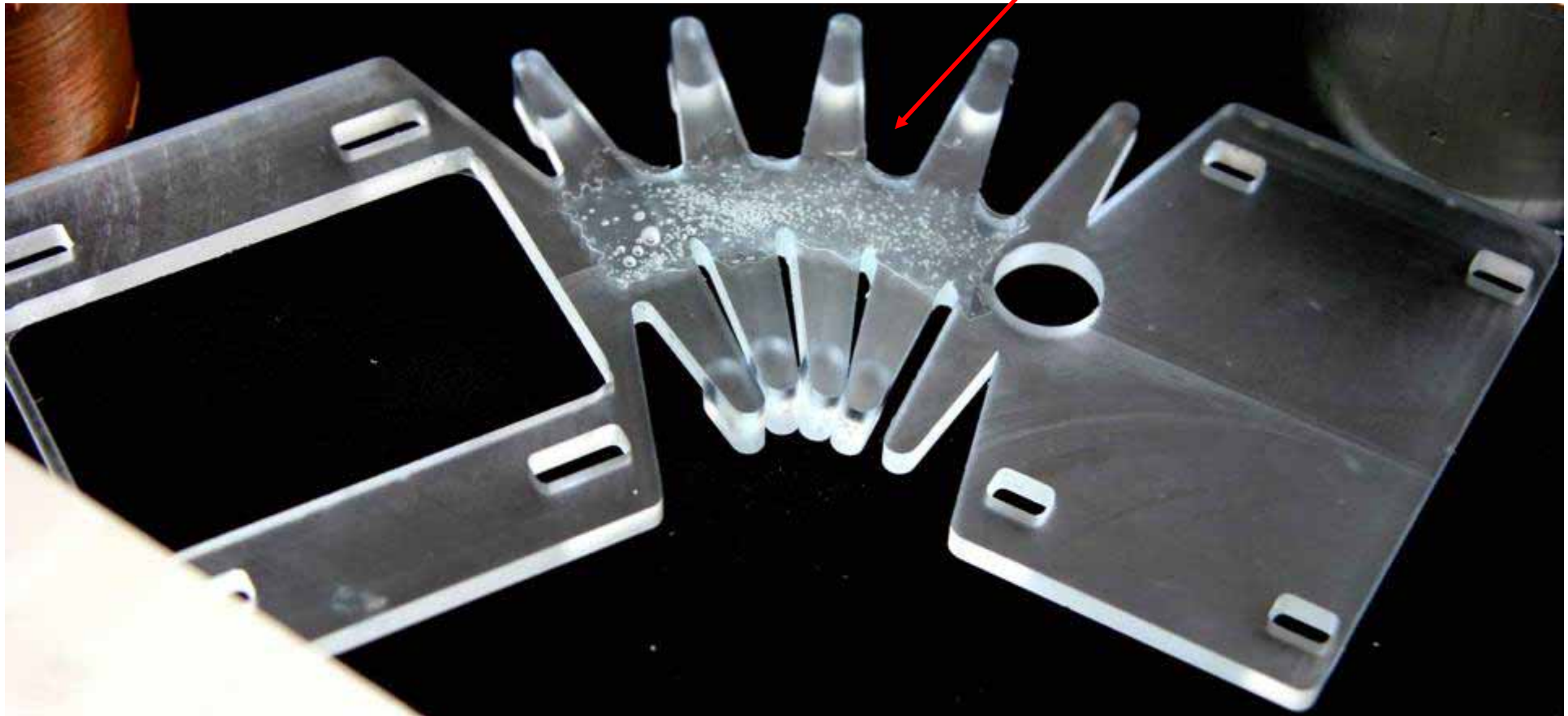

# Advantages and limits of the SDM Technology

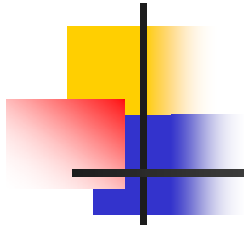

## Advantages:

- multi-material process
- no screws and bolts
- embedded mechanical and electronic components
- low cost
- almost any kind of shaping

## Limits:

- layered design and process
- no algorithms for developing
- bubbling during polymerization
- long process as rapid prototyping